



**YAVUZ PANO**



**Y-SYSTEM**  
Modüler Pano Sistemleri



**YAVUZ Light**  
Aydınlatma Sistemleri



**Xplastica**  
Kablo Taşıma Sistemleri



**PoLi**  
Plastik Pano Sistemleri



**NET-RACK**  
19" Data Sistemleri

**2012 FİYAT LİSTESİ**



## CANIKLI GRUP

**Y-SYSTEM**  
Modüler Pano Sistemleri

**POLİ**  
Plastik Pano Sistemleri

**NET-RACK**  
19" Data Sistemleri

**Xplastica**  
Kablo Taşıma Sistemleri

**VUZ Light**  
Aydınlatma Sistemleri

## Tarihçemiz

1989 yılında 200m<sup>2</sup> lik küçük bir atölye olarak kurulan YAVUZ PANO A.Ş. günümüzde 5000 m<sup>2</sup>lik imalat alanı ve ileri teknoloji sistemleri ile donatılmış geniş makine parkuruna sahip tesisleriyle ülkemiz pano sektörünün önemli kuruluşlarının başında gelmektedir. YAVUZ PANO A.Ş. olarak; A.G. ve O.G. enerji sistemlerinde kullanılan panoların projelendirilmesi, imalatı, montajı ve kontrol safhalarında 70'in üzerindeki uzman, deneyimli, eğitilmiş ve teknik kadrosuyla, elektrik sektörüne "tam hizmet" ve "tam destek" verebilmekteyiz. Sizce bu kadarlık büyüme hızı bize yeter mi? Elbette yetmez.

## Faaliyet Alanlarımız

Üretim ve hizmet konseptimiz; Türk standartları enstitüsü tarafından. İmalata Yeterlilik Belgesi ve Türk Standartlarına Uygunluk Belgesi verilerek onaylanmıştır. Firmamızın tüm çalışanlarının ISO 9001 - 2000 Kalite Sistemi çerçevesinde gerekli bilgi donanımına sahip olmanın verdiği bilinçle YAVUZ PANO A.Ş., bugüne kadar olduğu gibi bundan sonra da gerek teknoloji, gerek hizmet kalitesi, gerekse yatırım ve insana verdiği önemle sektördeki öncülüğünü sürdürmektedir. GOST-R belgemiz ile Rusya ve Türkiye Cumhuriyetlere, Ukrayna belgemiz ile Ukrayna'ya ürün satılabilmekteyiz. Firmamız Türkiye'de alçak gerilim panolarında tip testine (4000 A, 65kA) belgeye sahip firma olarak liderliğini sürdürmektedir.

Tasarımı tamamen YAVUZ PANO'ya ait olan panolarımızın hiçbirinde kaynak kullanmıyoruz. Yani müşterilerimiz aldıkları ürünleri daha sonra oluşabilecek ihtiyaçları dahilinde ekler yaparak tekrar kullanabilirler. Bu hem müşterilerimizin işletme maliyetini düşürür, hem de herhangi bir revizyon sırasında müdahale kolaylığı sağlamaktadır.

CNC Ağırlık ve CNC Punch tezgahlarında bilgisayar destekli olarak hazırladığımız ürünlerimizde bugün daha iyisini nasıl yapabiliriz düşüncesi ile yola çıktık. Şu anda panolarımızın köşe birleştirme elemanlarını zamak döküm olarak yapmaktayız. Ayrıca tamamen tasarımı ve kalıpları YAVUZ PANO bünyesinde hazırlanan, plastik enjeksiyon yöntemi ile modüler yapıda polikarbonat panolar üretebilmekteyiz.

## Kalite Politikamız

Çağdaş ticaret olgusunda var olabilmenin temel koşulunun "Müşteri Memnuniyeti" olduğu bilincindeyiz.

Bu bilinçle ileri teknolojinin imkanlarını kaliteli malzeme ile birleştirerek, müşterilerimize uluslar arası standartlarda ürün ve hizmet sunmak vazgeçemeyeceğimiz politikamızdır.

## Hedefimiz

Kendini her alanda ispatlamış sektörün lider kuruluşlarından biri olarak; geçmişte kazanılan yüksek bilgi ve deneyimlerimizi ileri teknolojinin imkanlarını da kullanarak, uluslar arası alanda kendini ispatlayacak ürünlerimizle farklı bir mühendislik anlayışı ile üretim yapma hedefindeyiz.

## Our Corporate History

*Yavuz Pano A.Ş. is one of the leading turkish manufacturers for electrical enclosures and 19" rack cabinets.*

*Our production and service concept is certified by the "Institute of Turkish Standards" with certificates of "Capability of Production" and "Conformity of Turkish Standards".*

*Within the ISO9001-2000 Quality System, with the consciousness of all our staff having the necessary information and background. Yavuz Pano A.Ş. is going to continue to pioneer in technology, quality of service and attaching importance to investments and human.*

*Do you think that this growth will be enough for us? Of course not.*

## Activity Areas

*Our production and service concept is certified by the .Institute of Turkish Standards, with certificates of .Capability of Production, and .Conformity of Turkish Standards.. Within the ISO 9001 - 2000 Quality System; with the consciousness of all our staff having the necessary information and background. YAVUZ PANO is going to continue to pioneer in technology, quality of service and attaching importance to investments and human. Additionally we are eligible to sell to Russia and Turk Republics by the means of our GOST-R and also eligible to sell Ukrania by means of our UKRANIA certificate. Our Firm one of the leading company in TURKEY having Low voltage Type Test (4000 A, 65kA) certificate.*

*Additionally all our panels are produced in modular form. We do not use welding in any of our products, which are completely of our own design. This enables our customers to make modifacations and additions upon changing needs in the future. This both reduces the cost of the units to our customers, and makes manipulation of the system extremely easier.*

*We have started work with the vision of making better today than yesterday, with our products which are designed with computed aid, and produced with CNC press brakes and CNC punch presses. Now we began to use for connection columns zamak alloy corner joint elements.*

*Moreover, we can manufacture products with modular structure made from polycarbonate manufactured using plastic injection method, for which design and moulds are fully provided under YAVUZ PANO.*

## Our Quality Policy

*We are aware of the fact that the fundamental condition of being able to exist in the world of commerce today is "Customer Satisfaction".*

*With this awareness and by combining the opportunities of high technology with high-quality materials, we provide products and services of international standards to our customers, and this is our policy which we will never give up.*

## Our Target

*As a leading company proven to be successful in every field in our sector, we aim to manufacture internationally proven products with a unique approach of engineering by using our high level of acquired know-how and experience and by employing the opportunities offered by advanced technology.*

## POLİ GRUBU / GROUP

POLİ-OPAK KAPAKLI TABAN SACLI PANOLAR	04
POLİ-ŞEFFAF KAPAKLI TABAN SACLI PANOLAR	05
POLİ-SIVA ALTI VE SIVA ÜSTÜ W OTOMAT KUTULARI	06
POLİ-SIVA ALTI SAYAÇ PANOLARI	07
POLİ-SIVA ÜSTÜ SAYAÇ VE DAĞITIM PANOLARI	08
POLİ-DAHİLİ DAĞITIM PANOLARI	09
POLİ-HARİCİ TİP ŞANTIYE PANOLARI	10
POLİ-MODÜLER SAHA PANOLARI	11
POLİ-KOMBİNASYON KUTULARI	12
FİŞ & PRİZLER	13
POLİ-BUAT KUTULARI	14
POLİ-TELEFON DAĞITIM PANOLARI	15
POLİ-TELEFON DAĞITIM AKSESUARLARI	16
POLİ-AKSESUARLAR	17

## Y-SYSTEM GRUBU / GROUP

CARISMA DİKİLİ TİP MODULER DAĞITIM PANOLARI	20
DUVAR TİPİ TABAN SACLI ETANJ PANOLAR	21-22
DUVAR TİPİ DAĞITIM PANOLARI	23
CARISMA DİKİLİ TİP MODULER PANOLARI	24

HARİCİ TİP ŞANTIYE TİPİ PANOLAR	25
DİKİLİ TİP VE DUVAR TİPİ PASLANMAZ PANOLAR	26
PULL TİPİ VE PİYANO TİPİ PANOLAR	27
EX PROOF PANOLAR	28

## **NET-RACK** GRUBU / GROUP

19" DİKİLİ SİSTEM RACK KABİNLER LONG RACK	30
SERVER RACK & PC RACK KABİNLER	31
DUVAR TİPİ RACK KABİNLER	32
AKSESUARLAR	33-34

## **Yplastico** GRUBU / GROUP

KABLO TAVASI - TAVA KAPAĞI	36
DÖNÜŞ ELEMANLARI	37
REDÜKSİYON - EK VE İÇ DIŞ BÜKEYLER	38
TAŞIMA PARÇALARI, VİDA VE SOMUNLAR	39
PLASTİK KABLO TAŞIMA SİSTEMİ	40



## GRUBU / GROUP

YOL VE CADDE ARMATÜRLERİ	42-43
ETANJ VE BANT ARMATÜRLER	44-46
PROJEKTÖRLER	47
ATÖLYE ARMATÜRLER	48
AKSESUARLAR	49

## **YAVUZ PANO** MATBUAT / THE PRESS

NEW TECH TİP TESTİ	50-51
ÖZEL ÜRÜNLER	52-54
BİLGİLER	55-56

**Poli 022**

**Poli 023**

**Poli 024**

**Poli 046**

**Poli 025**

**Poli 018**

**Poli 019**

**Poli 070**
**Teknik Detaylar / Technical Details**

Dahili ve Harici Uygulamalara Uygun	<i>Suitable for Indoor Use, Recessed Mounted</i>
IP:65 Koruma Sınıfı	<i>Protected up to IP:65</i>
Ral7035 Renkli	<i>Coloured Ral7035</i>
Yanma Dayanımı: -40°C / +120°C	<i>Heating Strength: -40°C / +120°C</i>
Toksit: Silikonsuz ve Halojeniz	<i>Toxic: Silicon &amp; Halogen Free</i>
Kimyasal Dayanım: Asit ve Bazlara Karşı Tam Koruma	<i>Chemical Resistance: Full Resistance for Acid and Chemical Bases</i>
Aşınma Dayanım: Olumsuz Hava Koşullarına (Kar-Buz-Gün Işığı) Karşı Yüksek Dayanım	<i>Wear Strength: High Strength for Negative Air Conditions</i>

Ref.No	Pano Ebatları Dimensions	Ağırlık (kg) Weight	Fiyat (TL) Price (TL)	Teslimat Delivery	Açıklama Description
Poli 018	225 x 425 x 115 mm	1.8	45.00TL	A	Koli Adedi: 10
Poli 019	355 x 560 x 135 mm	3.3	75.00TL	A	Koli Adedi: 5
Poli 022	250 x 300 x 130 mm	1.8	40.00TL	A	Koli Adedi: 10
Poli 023	300 x 400 x 150 mm	3.05	55.00TL	A	Koli Adedi: 5
Poli 024	400 x 500 x 180 mm	5.35	85.00TL	A	Koli Adedi: 5
Poli 025	500 x 700 x 200 mm	9.8	200.00TL	A	Koli Adedi: 1
Poli 046	400 x 600 x 230 mm	5.2	100.00TL	A	Koli Adedi: 4
Poli 068	600 x 800 x 280 mm	—	—	—	2012'de hizmetinizde
Poli 070	700 x 1150 x 350 mm	35.4	700.00TL	A	Koli Adedi: 1

**Teknik Detaylar / Technical Details**

Dahili ve Harici Uygulamalara Uygun *Suitable for Indoor Use, Recessed Mounted*

IP:65 Koruma Sınıfı *Protected up to IP:65*

Ral7035 Renkli *Coloured Ral7035*

Yanma Dayanımı: -40°C / +120°C *Heating Strength: -40°C / +120°C*

Toksit: Silikonsuz ve Halojeniz *Toxic: Silicon & Halogen Free*

Kimyasal Dayanım: Asit ve Bazlara Karşı Tam Koruma *Chemical Resistance: Full Resistance for Acid and Chemical Bases*

Aşınma Dayanımı: Olumsuz Hava Koşullarına (Kar-Buz-Gün Işığı) Karşı Yüksek Dayanım *Wear Strength: High Strength for Negative Air Conditions*

**Poli 026**

**Poli 027**

**Poli 028**

**Poli 047**

**Poli 029**

**Poli 034**

**Poli 020**

**Poli 021**

Ref.No	Pano Ebatları Dimensions	Ağırlık (kg) Weight	Fiyat (TL) Price(TL)	Teslimat Delivery	Açıklama Description
Poli 020	225 x 425 x 115 mm	2.1	52.00TL	A	Koli Adedi: 10
Poli 021	355 x 560 x 135 mm	3.88	75.00TL	A	Koli Adedi: 5
Poli 026	250 x 300 x 130 mm	2.0	52.00TL	A	Koli Adedi: 10
Poli 027	300 x 400 x 150 mm	3.12	67.00TL	A	Koli Adedi: 5
Poli 028	400 x 500 x 180 mm	3.42	118.00TL	A	Koli Adedi: 5
Poli 029	500 x 700 x 200 mm	9.9	262.00TL	A	Koli Adedi: 2
Poli 034	250 x 375 x 112 mm	1.68	30.00TL	A	Koli Adedi: 10
Poli 047	400 x 600 x 230 mm	5.3	122.00TL	A	Koli Adedi: 4



Poli 007



Poli 011



Poli 012



Poli 006



Poli 009



Poli 015



Poli 014



Poli 013



Poli 013-1

**Teknik Detaylar / Technical Details**

Dahili Uygulamalara Uygun, Sıva Üstü	Suitable for Indoor Use, Recessed Mounted
IP:65-42 Koruma Sınıfı	Protected up to IP:65-42
Ral7035 Renkli	Coloured Ral7035
Yanma Dayanımı: V2 Yanmazlık	Fire Proof Streght: V2 Fire Proof
Isı Dayanımı: -40°C / +120°C	Heating Strength: -40°C / +120°C
Toksit: Silikonsuz ve Halojeniz	Toxic: Silicon & Halogen Free
Kimyasal Dayanım: Asit ve Bazlara Karşı Tam Koruma	Chemical Resistance: Full Resistance for Acid and Chemical Bases
Aşınma Dayanımı: Olumsuz Hava Koşullarına (Kar-Buz-Gün Işığı) Karşı Yüksek Dayanım	Wear Streght: High Streght for Negative Air Conditions

Ref.No	Pano Ebatları Dimensions	Ağırlık (kg) Weight	Fiyat (TL) Price(TL)	Teslimat Delivery	Açıklama Description	Koli Package
<b>SIVA ÜSTÜ W OTOMAT KUTUSU</b>						
Poli 007	280 x 220 x 110 mm	0.84	17.50TL	A	12 W Otomat Kapasiteli 12 Module MCB Capacity	10 Adet
Poli 011	225 x 425 x 115 mm	1.8	45.00TL	A	18 W Otomat Kapasiteli-Bara Giriş Bölmeli 18 Module MCB Capacity-Busbar Entry Section	10 Adet
Poli 012	355 x 560 x 135 mm	3.45	75.00TL	A	36 W Otomat Kapasiteli-Bara Giriş Bölmeli 36 Module MCB Capacity-Busbar Entry Section	10 Adet
<b>SIVA ALTI W OTOMAT KUTUSU</b>						
Poli 006	150 x 211 x 100 mm	0.34	7.50TL	A	3-5 W Otomat Kapasiteli 3-5 Module MCB Capacity	-
Poli 009	375 x 250 x 122 mm	1.45	30.00TL	A	20 W Otomat Kapasiteli 20 Module MCB Capacity	10 Adet
Poli 013	290 x 211 x 100 mm	0.92	16.00TL	A	12 W Otomat Kapasiteli 12 Module MCB Capacity	22 Adet
Poli 013-1	281 x 201 x 90 mm	1.50	21.00TL	A	15 W Otomat Kapasiteli 15 Module MCB Capacity	10 Adet
Poli 014	290 x 386 x 100 mm	1.85	32.00TL	A	24 W Otomat Kapasiteli 24 Module MCB Capacity	-
Poli 015	290 x 561 x 100 mm	2.78	48.00TL	A	36 W Otomat Kapasiteli 36 Module MCB Capacity	-





Teknik Detaylar / Technical Details

Dahili Uygulamalara Uygun, Siva Altı	Suitable for Indoor Use, Recessed Mounted
IP:42 Koruma Sınıfı	Protected up to IP:42
Ral7035 Renkli (Şeffaf Kapak)	Coloured Ral7035 (Transpered Cover)
Yanma Dayanımı: V2 Yanmazlık	Fire Proof Strength: V2 Fireproof
Isı Dayanımı: -40°C / +120°C	Heating Strength: -40°C / +120°C
Toksit: Silikonsuz ve Halojeniz	Toxic: Silicon & Halogen Free
Kimyasal Dayanım: Asit ve Bazlara Karşı Tam Koruma	Chemical Resistance: Full Resistance for Acid and Chemical Bases



Ref.No	Pano Ebatları Dimensions	Ağırlık (kg) Weight	Fiyat (TL) Price(TL)	Teslimat Delivery	Açıklama Description	Koli Package
Poli 101	250 x 375 x 122 mm	1.45	30.00TL	A	1 Mono veya Trifaze Sayaç 10 Giriş Sigorta Kapasiteli	10 Adet
Poli 102	500 x 375 x 122 mm	2.95	60.00TL	A	2 Mono veya Trifaze Sayaç 20 Giriş Sigorta Kapasiteli	10 Adet
Poli 103	750 x 375 x 122 mm	4.40	85.00TL	A	3 Mono veya Trifaze Sayaç 30 Giriş Sigorta Kapasiteli	-
Poli 104	500 x 750 x 122 mm	7.30	110.00TL	A	4 Mono veya Trifaze Sayaç 40 Giriş Sigorta Kapasiteli	-
Poli 105	750 x 750 x 122 mm	10.2	160.00TL	A	5 Mono veya Trifaze Sayaç 50 Giriş Sigorta Kapasiteli	-
Poli 106	750 x 750 x 122 mm	10.2	160.00TL	A	6 Mono veya Trifaze Sayaç 60 Giriş Sigorta Kapasiteli	-
Poli 108	1000 x 750 x 122 mm	13.1	220.00TL	A	8 Mono veya Trifaze Sayaç 80 Giriş Sigorta Kapasiteli	-
Poli 110	1250 x 750 x 122 mm	16.0	275.00TL	A	10 Mono veya Trifaze Sayaç 100 Giriş Sigorta Kapasiteli	-
Poli 112	1500 x 750 x 122 mm	18.9	325.00TL	A	12 Mono veya Trifaze Sayaç 120 Giriş Sigorta Kapasiteli	-





### Teknik Detaylar / Technical Details

Dahili Uygulamalara Uygun, Sıva Üstü	Suitable for Indoor Use, Recessed Mounted
IP:65 Koruma Sınıfı	Protected up to IP:65
Ral7035 Renkli	Coloured Ral7035
Yanma Dayanımı: V2 Yanmazlık	Fire Proof Streght: V2 Fire Proof
Isı Dayanımı: -40°C / +120°C	Heating Strength: -40°C / +120°C
Toksit: Silikonsuz ve Halojensiz	Toxic: Silicon & Halogen Free
Kimyasal Dayanım: Asit ve Bazlara Karşı Tam Koruma	Chemical Resistance: Full Resistance for Acid and Chemical Bases
Aşınma Dayanımı: Olumsuz Hava Koşullarına (Kar-Buz-Gün Işığı) Karşı Yüksek Dayanım	Wear Strengh: High Strengh for Negative Air Conditions

Ref.No	Pano Ebatları Dimensions	Ağırlık (kg) Weight	Fiyat (TL) Price(TL)	Teslimat Delivery	Açıklama Description	Koli Package
Poli 016	225 x 425 x 115 mm	1.73	45.00TL	A	Monofaze Sayaç 9 Sigorta Kapasiteli Opak Kapak	10 Adet
Poli 017	355 x 565 x 135 mm	3.2	75.00TL	A	Trifaze Sayaç 12 Sigorta Kapasiteli Opak Kapak	5 Adet
Poli 038	250 x 300 x 130 mm	2.39	50.00TL	A	Monofaze Sayaç 6 Sigorta Kapasiteli Opak Kapak	10 Adet
Poli 038/1	300 x 400 x 150 mm	4.37	70.00TL	A	Monofaze Sayaç 15 Sigorta Kapasiteli Opak Kapak	10 Adet
Poli 039	400 x 500 x 180 mm	7.29	120.00TL	A	Trifaze Sayaç 1 Monofaze - 1 Trifaze Priz 12 Sigorta Kapasiteli	5 Adet
Poli 040	400 x 500 x 180 mm	7.29	120.00TL	A	Trifaze Sayaç 23 Sigorta Kapasiteli	5 Adet
Poli 041	500 x 700 x 200 mm	12.24	250.00TL	A	Trifaze Sayaç 30 Sigorta Kapasiteli Kompakt Şalter Yeri	2 Adet
Poli 042	500 x 700 x 200 mm	12.24	250.00TL	A	Trifaze Sayaç 40 Sigorta Kapasiteli 4'5 Priz Bölmesi	2 Adet
Poli 043	500 x 700 x 200 mm	12.24	250.00TL	A	Trifaze Sayaç 40 Sigorta Kapasiteli Kompakt Şalter Yeri	2 Adet
Poli 044	500 x 700 x 200 mm	12.24	250.00TL	A	Trifaze Sayaç 40 Sigorta Kapasiteli Klemens Yeri Opak	2 Adet
Poli 045	500 x 700 x 200 mm	13.86	250.00TL	A	X / 5 Sayaç Akım Trafosu Kompakt Şalter	2 Adet
Poli 044M	500 x 700 x 200 mm	13.86	290.00TL	A	Şapkalı Motor Panosu	1 Adet

**Teknik Detaylar / Technical Details**

Dahili Uygulamalara Uygun, Sıva Üstü	<i>Suitable for Indoor Use, Recessed Mounted</i>
IP:65 Koruma Sınıfı	<i>Protected up to IP:65</i>
Ral7035 Renkli	<i>Coloured Ral7035</i>
Yanma Dayanımı: V2 Yanmazlık	<i>Fire Proof Strength: V2 Fire Proof</i>
Isı Dayanımı: -40°C / +120°C	<i>Heating Strength: -40°C / +120°C</i>
Toksit: Silikonsuz ve Halojeniz	<i>Toxic: Silicon &amp; Halogen Free</i>
Kimyasal Dayanım: Asit ve Bazlara Karşı Tam Koruma	<i>Chemical Resistance: Full Resistance for Acid and Chemical Bases</i>
Aşınma Dayanımı: Olumsuz Hava Koşullarına (Kar-Buz-Gün Işığı) Karşı Yüksek Dayanım	<i>Wear Strength: High Strength for Negative Air Conditions</i>

**Poli 051**

**Poli 052**

**Poli 053**

**Poli 054**

Ref.No	Pano Ebatları Dimensions	Ağırlık (kg) Weight	Fiyat (TL) Price(TL)	Teslimat Delivery	Açıklama Description	Koli Package
Poli 025-K	500 x 700 x 200 mm	10.30	260.00TL	A	Kompanzasyon Panosu	-
Poli 025-DK	1000 x 700 x 200 mm	22.30	450.00TL	A	Dağıtım-Kompanzasyon Panosu 60 Sigorta TMS, Kompanzasyon Bölümü	-
Poli 025-SDK	1000 x 700 x 200 mm	22.30	450.00TL	A	Sayıç-Dağıtım Kompanzasyon Bölümü, 40 Sigorta Kapasiteli, 4'lü Priz Grubu, Klemens Bölümü	-
Poli 051	500 x 700 x 200 mm	12.30	250.00TL	A	Kompakt Şalter, 40 Sigorta Kapasiteli, Klemens Bölümü	-
Poli 052	500 x 700 x 200 mm	12.30	250.00TL	A	Kompakt Şalter, 60 Sigorta Kapasiteli	-
Poli 053	500 x 700 x 200 mm	12.30	250.00TL	A	60 Sigorta Kapasiteli Klemens Bölümü	-
Poli 054	500 x 700 x 200 mm	12.30	250.00TL	A	30 Sigorta Kapasiteli 2'li Priz Grubu, Pako Şalter	-
Poli 055	400 x 500 x 180 mm	8.40	120.00TL	A	15 Sigorta Kapasiteli Pako Şalter, Klemens Bölümü	-
Poli 056	400 x 500 x 180 mm	8.40	120.00TL	A	45 Sigorta Kapasiteli	5 Adet
Poli 057	400 x 500 x 180 mm	8.40	120.00TL	A	30 Sigorta Kapasiteli Klemens Bölümü	5 Adet
Poli 058	400 x 500 x 180 mm	8.40	120.00TL	A	20 Sigorta Kapasiteli Klemens Bölümü	5 Adet
Poli 061	300 x 400 x 150 mm	5.60	70.00TL	A	20 Sigorta Kapasiteli Klemens Bölümü	10 Adet
Poli 062	300 x 400 x 150 mm	5.60	70.00TL	A	10 Sigorta Kapasiteli Klemens Bölümü	10 Adet
Poli 063	250 x 300 x 130 mm	1.70	50.00TL	A		
Poli 064	250 x 300 x 130 mm	1.70	50.00TL	A		

**Poli 055**

**Poli 056**

**Poli 057**

**Poli 058**

**Poli 061**

**Poli 062**

**Poli 025-K**

**Poli 025-SDK**

**Poli 025-DK**

**Poli 063**

**Poli 064**

Teslim Süreleri : ✓ A → Stok Teslim    ✓ B → 3 İş Günü    ✓ C → Sorunuz

**Poli 037-Ş**

**Poli 040-Ş**

**Poli 024-Ş1**

**Poli 024-Ş3**

**Poli 024-Ş4**

**Poli 035**

**Poli 036**

**Poli 037**
**Teknik Detaylar / Technical Details**

Harici Uygulamalara Uygun	<i>Suitable for Outdoor</i>
IP:65 Koruma Sınıfı	<i>Protected up to IP:65</i>
Ral7035 Renkli	<i>Coloured Ral7035</i>
Yanma Dayanımı: V2 Yanmazlık	<i>Fire Proof Streght: V2 Fire Proof</i>
Isı Dayanımı: -40°C / +120°C	<i>Heating Strength: -40°C / +120°C</i>
Toksit: Silikonsuz ve Halojeniz	<i>Toxic: Silicon &amp; Halogen Free</i>
Kimyasal Dayanım: Asit ve Bazlara Karşı Tam Koruma	<i>Chemical Resistance: Full Resistance for Acid and Chemical Bases</i>
Aşınma Dayanımı: Olumsuz Hava Koşullarına (Kar-Buz-Gün Işığı) Karşı Yüksek Dayanım	<i>Wear Strength: High Strengh for Negative Air Conditions</i>

Ref.No	Pano Ebatları Dimensions	Ağırlık (kg) Weight	Fiyat (TL) Price(TL)	Teslimat Delivery	Açıklama Description
<b>Duvar Tipi Şantiye Panoları</b>					
Poli 040-Ş	400 x 500 x 180 mm	8.15	140.00 TL	A	Trifaze Sayaç, 19 Sigorta Kapasiteli, 5'li Priz Grubu (Duvar Tipi)
Poli 037-Ş	500 x 700 x 200 mm	12.8	270.00 TL	A	Trifaze Sayaç, 30 Sigorta Kapasiteli, 4'lü Priz Grubu (Duvar Tipi)
<b>Ayaklı Tip Şantiye Panoları</b>					
Poli 024-Ş1	400 x 500 x 180 mm	11	160.00 TL	A	Trifaze Sayaç, 19 Sigorta Kapasiteli, 6'li Priz Grubu (Ayaklı Tip)
Poli 024-Ş3	400 x 500 x 180 mm	10.2	160.00 TL	A	Trifaze Sayaç, 12 Sigorta Kapasiteli, 1 Monofaz / 1 Trifaze Priz Yeri (Ayaklı Tip)
Poli 024-Ş4	400 x 500 x 180 mm	11	160.00 TL	A	Bara Giriş Bölmeli 30 Sigorta Kapasiteli 6'li Priz Grubu (Ayaklı Tip)
Poli 035	500 x 700 x 200 mm	16	290.00 TL	A	Trifaze Sayaç, 30 Sigorta Kapasiteli, 10'lü Priz Grubu (Ayaklı Tip)
Poli 036	500 x 700 x 200 mm	15.5	290.00 TL	A	Trifaze Sayaç, 30 Sigorta Kapasiteli, Kompakt Şalter Yeri (Ayaklı Tip)
Poli 037	500 x 700 x 200 mm	15.5	290.00 TL	A	Trifaze Sayaç, 30 Sigorta Kapasiteli, 4'lü Priz Grubu (Ayaklı Tip)

Teslim Süreleri : ✓ A → Stok Teslim ✓ B → 3 İş Günü ✓ C → Sorunuz

**Teknik Detaylar / Technical Details**

Harici Uygulamalara Uygun, Sıva Üstü	<i>Suitable for Outdoor, Recessed Mounted</i>
IP:65 Koruma Sınıfı	<i>Protected up to IP:65</i>
Ral7035 Renkli	<i>Coloured Ral7035</i>
Yanma Dayanımı: V2 Yanmazlık	<i>Fire Proof Streght: V2 Fire Proof</i>
Isı Dayanımı: -40°C / +120°C	<i>Heating Strength: -40°C / +120°C</i>
Epoksi Polyester	<i>Fiber Glass</i>
Kimyasal Dayanım: Asit ve Bazlara Karşı Tam Koruma	<i>Chemical Resistance: Full Resistance for Acid and Chemical Bases</i>
Aşınma Dayanımı: Olumsuz Hava Koşullarına (Kar-Buz-Gün Işığı) Karşı Yüksek Dayanım	<i>Wear Strengh: High Strengh for Negative Air Conditions</i>

**Poli 070**

**Poli 071**

**Poli 072**

**Poli 073**

Ref.No	Pano Ebatları Dimensions	Ağırlık (kg) Weight	Fiyat (TL) Price(TL)	Teslimat Delivery	Açıklama Description
Poli 070	700 x 1150 x 350 mm	35.4	700.00 TL	A	Taban Sachı, Tek Kapılı With Back Plate, Single Door
Poli 071	700 x 1150 x 350 mm	40.1	800.00 TL	A	Çift Kapılı (Arka-Ön) Double Door (Back-Front)
Poli 072	1400 x 2150 x 350 mm	71	1600.00 TL	A	Taban Sachı, Çift Kapılı (Sağ-Sol), Modül With Back Plate, Double Door (Left-Right) Double Module
Poli 073	700 x 2150 x 350 mm	71	1600.00 TL	A	Taban Sachı, Çift Kapılı (Alt-Üst), Modül With Back Plate, Double Door (Back-front) Double Module
Poli 074	700 x 150 x 350 mm	6	120.00 TL	A	15 cm'lik Baza 15 cm Base
Poli 075	700 x 300 x 350 mm	10	240.00 TL	A	30 cm'lik Baza 30 cm Base
Poli 076	700 x 450 x 350 mm	14	360.00 TL	A	45 cm'lik Baza 45 cm Base

**Poli 076**

**Poli 075**

**Poli 074**

Teslim Süreleri : ✓ A → Stok Teslim    ✓ B → 3 İş Günü    ✓ C → Sorunuz

**Poli 030**

**Poli 031**

**Poli 031-P1**

**Poli 031-P2**

**Poli 031-P3**

**Poli 030-P3**

**Poli 030-P4**

**Poli 030-P5**

**Poli 030-P6**

**Poli 030-P11**

**Poli 030-P13**
**Teknik Detaylar / Technical Details**

Dahili Uygulamalara Uygun, Sıva Üstü	<i>Suitable for Indoor Use, Recessed Mounted</i>
IP:65 Koruma Sınıfı	<i>Protected up to IP:65</i>
Ral7035 Renkli	<i>Coloured Ral7035</i>
Yanma Dayanımı: V2 Yanmazlık	<i>Fire Proof Strength: V2 Fire Proof</i>
Isı Dayanımı: -40°C / +120°C	<i>Heating Strength: -40°C / +120°C</i>
Toksit: Silikonsuz ve Halojeniz	<i>Toxic: Silicon &amp; Halogen Free</i>
Kimyasal Dayanım: Asit ve Bazlara Karşı Tam Koruma	<i>Chemical Resistance: Full Resistance for Acid and Chemical Bases</i>
Aşınma Dayanımı: Olumsuz Hava Koşullarına (Kar-Buz-Gün Işığı) Karşı Yüksek Dayanım	<i>Wear Strength: High Strength for Negative Air Conditions</i>

Ref.No	Pano Ebatları Dimensions	Ağırlık (kg) Weight	Fiyat (TL) Price(TL)	Teslimat Delivery	Açıklama Description
<b>Contalı Boş Kombinasyon Kutuları</b>					
Poli 031	120 x 220 x 110 mm	0.42	11.50TL	A	5 Sigorta Kapasiteli Boş Kombinasyon Kutusu (Küçük Tip)
Poli 030	220 x 280 x 120 mm	0.87	20.00TL	A	9 Sigorta Kapasiteli Boş Kombinasyon Kutusu (Küçük Tip)
<b>Contalı Prizli Kombinasyon Kutuları</b>					
Poli 031-P1	120 x 220 x 110 mm	0.58	19.90TL	A	5 Sigorta Kapasiteli 3x25A Priz (1 Adet) (Küçük Tip)
Poli 031-P2	120 x 220 x 110 mm	0.62	27.00TL	A	3x25A Priz (1 Adet), 1x16A Priz (2 Adet) 5 Sigorta Kapasiteli (Küçük Tip)
Poli 031-P3	120 x 220 x 110 mm	0.63	25.90TL	A	1x16A Priz (Ün, 2 Adet), 1x16A (Ara, 2 Adet) 5 Sigorta Kapasiteli (Küçük Tip)
Poli 030-P3	220 x 280 x 120 mm	1.155	42.80TL	A	3x25A Priz (1 Adet), 1x16A (4 Adet) 9 Sigorta Kapasiteli (Büyük Tip)
Poli 030-P4	220 x 280 x 120 mm	1.065	36.80TL	A	3x25A Priz (2 Adet) 5 Sigorta Kapasiteli (Büyük Tip)
Poli 030-P5	220 x 280 x 120 mm	1.15	44.00TL	A	3x25A Priz (2 Adet), 1x16A (2 Adet) 9 Sigorta Kapasiteli (Büyük Tip)
Poli 030-P6	220 x 280 x 120 mm	1.25	51.20TL	A	3x25A Priz (2 Adet), 1x16A (4 Adet) 9 Sigorta Kapasiteli (Büyük Tip)
Poli 030-P11	220 x 280 x 120 mm	1.205	48.80TL	A	1x16A Priz (Ün, 6 Adet), 1x16A (Yan, 2 Adet), 9 Sigorta Kapasiteli (Büyük Tip)
Poli 030-P13	220 x 280 x 120 mm	1.32	52.00TL	A	5x32A Priz (1 Adet), 3x25A Priz (1 Adet), 1x16A Priz (2 Adet) (Büyük Tip)

Teslim Süreleri : ✓ A → Stok Teslim    ✓ B → 3 İş Günü    ✓ C → Sorunuz

Ref.No	Detay Details	Fiyat (TL) Price(TL)	Açıklama Description
<b>Prizler</b>			
YPA 125	1x16A Pano Prizi	3.6TL	Monofaze Priz 1P+N <i>Monophase Socket 1P+N</i>
YPA 124	3x25A Makine Prizi	8.40TL	Trifaze Priz 3P+N <i>Triphase Socket 3P+N</i>
P332	3x32A Makine Prizi	12.50TL	Trifaze Priz 3P+N <i>Triphase Socket 3P+N</i>
P532	5x32A Makine Prizi	15.60TL	Trifaze Priz 3P+N+Pe <i>Triphase Socket 3P+N+Pe</i>
P563	5x63A Makine Prizi	49.20TL	Trifaze Priz 3P+N+Pe <i>Triphase Socket 3P+N+Pe</i>
YPA 129	1x16A 3'lü Grup Priz	12.50TL	Monofaze Priz 1P+N <i>Monophase Socket 1P+N</i>
<b>Fişler</b>			
F116	1x16A Düz Fiş	4.00TL	Monofaze Fiş 1P+N <i>Monophase Plug 1P+N</i>
F316	3x16A Düz Fiş	7.50TL	Trifaze Fiş 3P+N <i>Triphase Plug 3P+N</i>
YPA 126	3x25A Düz Fiş	6.50TL	Trifaze Fiş 3P+N <i>Triphase Plug 3P+N</i>
F332	3x32A Düz Fiş	11.00TL	Trifaze Fiş 3P+N <i>Triphase Plug 3P+N</i>
F532	5x32A Düz Fiş	12.00TL	Trifaze Fiş 3P+N+Pe <i>Triphase Plug 3P+N+Pe</i>
F563	5x63A Düz Fiş	48.00TL	Trifaze Fiş 3P+N+Pe <i>Triphase Plug 3P+N+Pe</i>



YPA125



YPA124



P332



P532



P563



YPA129



F316



F332



F532



F563



F116



YPA126



Teknik Detaylar / Technical Details

Dahili Uygulamalara Uygun, Sıva Üstü	Suitable for Indoor Use, Recessed Mounted
IP:65 Koruma Sınıfı	Protected up to IP:65
Ral7035 Renkli	Coloured Ral7035
Yanma Dayanımı: V2 Yanmazlık	Fire Proof Streght: V2 Fire Proof
Isı Dayanımı: -40°C / +120°C	Heating Strength: -40°C / +120°C
Toksit: Silikonsuz ve Halojensiz	Toxic: Silicon & Halogen Free
Kimyasal Dayanım: Asit ve Bazlara Karşı Tam Koruma	Chemical Resistance: Full Resistance for Acid and Chemical Bases



Poli 033



Poli 033-Ş



Poli 032



Poli 032-Ş

Ref.No	Pano Ebatları Dimensions	Ağırlık (kg) Weight	Fiyat (TL) Price(TL)	Teslimat Delivery	Açıklama Description	Koli Package
Poli 032	120 x 220 x 110 mm	0.25	8.00TL	A	Opak Kapaklı Buat Kutusu Coloured lid, Junction Boxes	16 Adet
Poli 032-Ş	120 x 220 x 110 mm	0.26	9.00TL	A	Şeffaf Kapaklı Buat Kutusu Transparent lid, Junction Boxes	16 Adet
Poli 033	220 x 280 x 110 mm	0.59	14.00TL	A	Opak Kapaklı Buat Kutusu Coloured lid, Junction Boxes	6 Adet
Poli 033-Ş	220 x 280 x 110 mm	0.63	14.00TL	A	Şeffaf Kapaklı Buat Kutusu Transparent lid, Junction Boxes	6 Adet
Poli 032-1	300 x 350 x 110 mm	-	-	C	Tasarım Aşamasında	-
Poli 032-2	300 x 300 x 110 mm	-	-	C	Tasarım Aşamasında	-
Poli 032-3	220 x 350 x 110 mm	-	-	C	Tasarım Aşamasında	-
BK 111	Tekli Sac Kasası Switch Boxes - Single	-	-	C	Üretim Aşamasında	-
BK 222	Çiftli Sac Kasası Switch Boxes - Double	-	-	C	Üretim Aşamasında	-

Teslim Süreleri : ✓ A → Stok Teslim ✓ B → 3 İş Günü ✓ C → Sorunuz



**Teknik Detaylar / Technical Details**

Dahili Uygulamalara Uygun, Sıva Üstü	<i>Suitable for Indoor Use, Recessed Mounted</i>
IP:65 Koruma Sınıfı	<i>Protected up to IP:65</i>
Ral7035 Renkli	<i>Coloured Ral7035</i>
Yanma Dayanımı: V2 Yanmazlık	<i>Fire Proof Streght: V2 Fire Proof</i>
Isı Dayanımı: -40°C / +120°C	<i>Heating Strength: -40°C / +120°C</i>
Toksit: Silikonsuz ve Halojeniz	<i>Toxic: Silicon &amp; Halogen Free</i>
Kimyasal Dayanım: Asit ve Bazlara Karşı Tam Koruma	<i>Chemical Resistance: Full Resistance for Acid and Chemical Bases</i>

**Poli 084**

**Poli 085**

**Poli 087**

**Poli 088**

**Poli 089**

Ref.No	Pano Ebatları Dimensions	Fiyat (TL) Price(TL)	Teslimat Delivery	Açıklama Description
Poli 080	85 x 160 x 60 mm	7.20TL	A	10-20 Per Arası Sıva Üstü 10-20 Pair Wall Mounted
Poli 081	220 x 280 x 110 mm	23.50TL	A	20-50 Per Arası Sıva Üstü 20-50 Pair Wall Mounted
Poli 082	250 x 375 x 122 mm	38.80TL	A	10-100 Per Arası Sıva Üstü 10-100 Pair Wall Mounted
Poli 083	225 x 425 x 115 mm	63.80TL	A	20-100 Per Arası Sıva Üstü 20-100 Pair Wall Mounted
Poli 084	250 x 300 x 130 mm	48.80TL	A	20-100 Per Arası Sıva Üstü 20-100 Pair Wall Mounted
Poli 085	300 x 400 x 150 mm	68.20TL	A	100-150 Per Arası Sıva Üstü 100-150 Pair Wall Mounted
Poli 086	335 x 560 x 135 mm	116.40TL	A	200-300 Per Arası Sıva Üstü 200-300 Pair Wall Mounted
Poli 087	400 x 500 x 180 mm	111.40TL	A	200-300 Per Arası Sıva Üstü 200-300 Pair Wall Mounted
Poli 088	400 x 600 x 230 mm	144.00TL	A	400-500 Per Arası Sıva Üstü 400-500 Pair Wall Mounted
Poli 089	500 x 700 x 200 mm	253.00TL	A	400-600 Per Arası Sıva Üstü 400-600 Pair Wall Mounted
Poli 090	700 x 1150 x 350 mm	806.00TL	A	1200-2400 Per Arası Sıva Üstü 1200-2400 Pair Wall Mounted

**Poli 080**

**Poli 081**

**Poli 082**

**Poli 083**

**Poli 086**

**Poli 090**

Teslim Süreleri : ✓ A → Stok Teslim    ✓ B → 3 İş Günü    ✓ C → Sorunuz



YPA 040



YPA 041



YPA 042



YPA 043



YPA 044



YPA 045



YPA 046

Ref.No	Pano Ebatları Dimensions	Fiyat (TL) Price(TL)	Teslimat Delivery	Açıklama Description
<b>REGLETLER</b>				
YPA 040	Kesmesiz Modül Reglet	3.40TL	B	Reglet Pair
YPA 040-1	Kesmeli Modül Reglet	4.60TL	B	Reglet Pair
<b>ÇATILAR</b>				
YPA 041	1'li Çatı 42 mm 1 Module	0.88TL	B	Paslanmaz Stainless Steel
YPA 042	2'li Çatı 42 mm 2 Module	1.76TL	B	Paslanmaz Stainless Steel
YPA 043	3'lü Çatı 42 mm 3 Module	2.64TL	B	Paslanmaz Stainless Steel
YPA 044	4'lü Çatı 42 mm 4 Module	3.52TL	B	Paslanmaz Stainless Steel
YPA 045	5'li Çatı 42 mm 5 Module	4.40TL	B	Paslanmaz Stainless Steel
YPA 046	10'lu Çatı 42 mm 10 Module	8.80TL	B	Paslanmaz Stainless Steel
YPA 047	15'li Çatı 60 mm 15 Module	13.20TL	B	Paslanmaz Stainless Steel
YPA 048	20'li Çatı 42 mm 20 Module	17.60TL	B	Paslanmaz Stainless Steel
YPA 049	25'li Çatı 60 mm 25 Module	22.00TL	B	Paslanmaz Stainless Steel
YPA 050	30'lu Çatı 60 mm 30 Module	26.40TL	B	Paslanmaz Stainless Steel
YPA 051	40'lu Çatı 60 mm 40 Module	35.20TL	B	Paslanmaz Stainless Steel

Teslim Süreleri : ✓ A → Stok Teslim ✓ B → 3 İş Günü ✓ C → Sorunuz

Ref.No	Detay Detail	Fiyat (TL) Price(TL)	Açıklama Description
<b>RAYLAR</b>			
YPA 027-0.5	0.5 m	1.25TL	0.5 m Otomat Rayı
YPA 027-1	1 m	2.50TL	1 m Otomat Rayı
YPA 027-1.5	1.5 m	3.60TL	1.5 m Otomat Rayı
YPA 027-2	2 m	4.80TL	2 m Otomat Rayı
<b>BARA DAĞITIM ÜNİTESİ VE BARALI KLEMENSLER</b>			
YPA 029-1	9'lu	2.00TL	Baralı Klemens
YPA 029-2	15'li	6.00TL	Baralı Klemens
YPA 029-3	30'lu	9.50TL	Baralı Klemens
YPA 030	4P Dağıtım Ünitesi	35.00TL	25x4 Delikli/25'li Kablo Girişi
<b>İZOLATÖRLER</b>			
YPA 034	M6 İzolatör	2.00TL	Yuvarlak - Tek Taraf Erkek
YPA 035	M6 İzolatör	2.00TL	Yuvarlak - Tek Taraf Dişi
YPA 036	M6 İzolatör	1.00TL	Yuvarlak - Çift Taraf Erkek
YPA 037	M8 İzolatör	2.10TL	Yuvarlak - Tek Taraf Erkek
YPA 038	M8 İzolatör	2.34TL	Yuvarlak - Tek Taraf Dişi
YPA 039	M8 İzolatör	1.80TL	Yuvarlak - Çift Taraf Erkek
<b>PROJE CEPLERİ</b>			
YPA 010	A4 Proje Cebi	3.50TL	Büyük Cep
YPA 011	A5 Proje Cebi	3.00TL	Küçük Cep
<b>FAN - TERMOSTAT - FİLTRELER</b>			
YPA 015	Termostat 220V	48.00TL	220V
YPA 016	120x120 Fan	15.00TL	
YPA 017	150x150 Filtre	2.50TL	
YPA 018	250x250 Filtre	16.00TL	
<b>TARAK İZOLATÖRLER</b>			
YPA 025	3x1 F Tarak	6.50TL	Kutu Adedi 65
YPA 025 Y	1x2 F Tarak	7.50TL	Kutu Adedi 42
YPA 026	3x2 F Tarak	7.65TL	Kutu Adedi 40
<b>KOFRA VE PERDE ETİKETİ</b>			
YPA 120	NH Altıklı Kofra	40.00TL	Polyester
YPA 027E	PErde Etiket Şeridi	3.50TL	43 cm

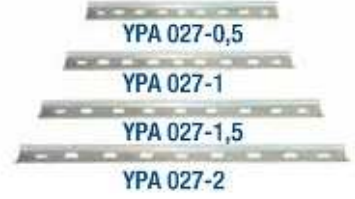

YPA 016



YPA 018



YPA 017



YPA 015



YPA 034



YPA 035



YPA 036



YPA 037



YPA 038



YPA 039



YPA 025



YPA 026

Teslim Süreleri : ✓ A → Stok Teslim ✓ B → 3 İş Günü ✓ C → Sorunuz

**Y-SYSTEM**

PANO SİSTEMLERİNDE  
PROFESYONEL ÇÖZÜM ORTAĞINIZ



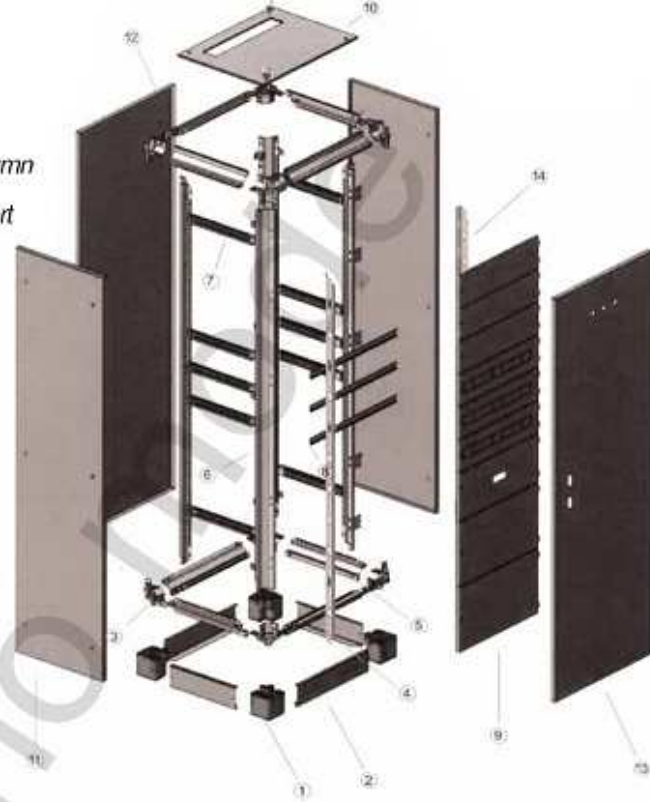

1. Baza Köşesi / Base Corner
2. Baza Kapama Parçası / Base Closing Part
3. Pano Köşesi / Panel Corner
4. Yatay Bağlantı Elemanı / Horizontal Width Column
5. Derinlik Bağlantı Elemanı / Horizontal Depth Part
6. Direk / Hight Column
7. Derinlik Kızağı / Side Brass
8. Yan Bölme / Internal Panels
9. Örtü plakaları / Coverplate
10. Şapka / Top Hat
11. Yan Kapı / Side Door
12. Arka Kapı / Back Door
13. Ön Kapı / Front Door
14. Yan Sütun / Side Column



#### Teknik Detaylar / Technical Details

Konstrüksiyon: %100 Modüler Kaynaksız	Construction: Fully Modular Not Welded
Gövde: 2mm Dkp Sac	Body: 2mm Mild Steel
Kapı: 2mm Dkp Sac	Door: 2mm Mild Steel
Taban Sacı: 2mm Galvaniz Sac	Cover Plates: 2mm Mild Steel
Boya: Ral7032 Elektrostatik Toz Boya	Paint: Ral7032 Electrostatic Powder Coating
Koruma Derecesi: IP 41/54	Protection Degree: IP 41/54
Contalama Sist: Poliüretan Dökme Conta	Foam Gasket: Polyurethane Foam
Ön Kapı: 3 Noktalı Kilitleme 180° Açılabilir Kapı	Front Door: 3 Point Locking System
Mentеше: 4 Noktadan Gizli Mentеше	Hinges: 4 Point Secret Hinges
Kablo Giriş Çıkış: Var	Cable Entry & Outgoing: Available

DAĞITIM PANOLARI	f.No	Pano Ebatları Dimensions	Ağırlık (kg) Weight	Fiyat (TL) Price(TL)	Teslimat Delivery	Açıklama Description
	YPC 121	600 x 1820 x 500 mm	130	870.00TL	C	
	YPC 122	700 x 1820 x 500 mm	140	1000.00TL	C	
	YPC 123	800 x 1820 x 500 mm	150	1150.00TL	C	
	YPC 124	600 x 2060 x 500 mm	140	980.00TL	C	
	YPC 125	700 x 2060 x 500 mm	155	1150.00TL	C	
	YPC 126	800 x 2060 x 500 mm	165	1420.00TL	C	

TABAN SACLI PANOLAR	Ref.No	Pano Ebatları Dimensions	Ağırlık (kg) Weight	Fiyat (TL) Price(TL)	Teslimat Delivery	Açıklama Description
	YPC 101	600 x 1820 x 500 mm	125	850.00TL	C	
	YPC 102	700 x 1820 x 500 mm	135	980.00TL	C	
	YPC 103	800 x 1820 x 500 mm	145	1120.00TL	C	
	YPC 104	600 x 2060 x 500 mm	135	960.00TL	C	
	YPC 105	700 x 2060 x 500 mm	150	1120.00TL	C	
	YPC 106	800 x 2060 x 500 mm	160	1400.00TL	C	

SAYAÇ PANOLARI	Ref.No	Pano Ebatları Dimensions	Ağırlık (kg) Weight	Fiyat (TL) Price(TL)	Teslimat Delivery	Açıklama Description
	YPC 141	600 x 2140 x 500 mm	130	900.00TL	C	6 Trifaze Sayaç-Çıkış Sigortası-Bara yeri
	YPC 142	700 x 2140 x 500 mm	155	1170.00TL	C	9 Trifaze Sayaç-Çıkış Sigortası-Bara yeri
	YPC 143	800 x 2140 x 500 mm	190	1400.00TL	C	12 Trifaze Sayaç-Çıkış Sigortası-Bara yeri

Teslim Süreleri : ✓ A → Stok Teslim    ✓ B → 3 İş Günü    ✓ C → Sorunuz



### Teknik Detaylar / Technical Details

Konstrüksiyon: Kaynaklı Gövde	Construction: Welded Body
Gövde: 1mm/1.5mm Dkp Sac	Body: 1mm/1.5mm Mild Steel
Kapı: 1/1.5mm Dkp Sac	Door: 1/1.5 mm Mild Steel
Örtü Sacları: 1mm Dkp Sac	Cover Plates: 1mm Mild Steel
Boya: Ral7032 Elektrostatik Toz Boya	Paint: Ral7032 Electrostatic Powder Coating
Koruma Derecesi: IP 41/54	Protection Degree: IP 41/54
Contalama Sist: Poliüretan Dökme Conta	Foam Gasket: Polyurethane Foam
Ön Kapı: 1/2 Noktalı Kilitleme	Front Door: 1/2 Point Locking System
Menteşe: 2/3 Noktadan Gizli Menteşe	Hinges: 2/3 Point Secret Hinges
Kablo Giriş Çıkış: Var	Cable Entry & Outgoing: Available



### EKO SERİ TABAN SACLI PANOLAR

Ref.No	Pano Ebatları Dimensions	Ağırlık (kg) Weight	Sac Kalınlığı Thickness	Fiyat (TL) Price(TL)	Teslimat Delivery	Açıklama Description
YP 209	250 x 300 x 150 mm	4	1mm	40.00TL	A	<ul style="list-style-type: none"> <li>* Taban saclı panolar.</li> <li>* Giriş-Çıkış için özel conta kapatma.</li> <li>* Sağa-Sola açılabilir kapı.</li> <li>* Kapı contası poliüretan dökme conta.</li> <li>* Kapı ve gövde topraklama bağlantı yeri.</li> </ul>
YP 210	300 x 400 x 150 mm	6	1mm	60.00TL	A	
YP 211	400 x 500 x 150 mm	9	1mm	100.00TL	A	
YP 212	400 x 600 x 200 mm	12	1mm	107.00TL	A	
YP 214	500 x 700 x 200 mm	17	1mm	175.00TL	A	
YP 215	600 x 800 x 250 mm	32	1,5mm	220.00TL	A	
YP 216	600 x 1000 x 300 mm	40	1,5mm	278.00TL	A	



EKO SERİ PANOLAR





### Teknik Detaylar / Technical Details

Konstrüksiyon: Kaynaklı Gövde	Construction: Welded Body
Gövde: 1mm/1.5mm Dkp Sac	Body: 1mm/1.5mm Mild Steel
Kapı: 1/1.5 mm Dkp Sac	Door: 1/1.5 mm Mild Steel
Örtü Sacları: 1mm Dkp Sac	Cover Plates: 1mm Mild Steel
Boya: Ral7032 Elektrostatik Toz Boya	Paint: Ral7032 Electrostatic Powder Coating
Koruma Derecesi: IP 41/54	Protection Degree: IP 41/54
Contalama Sist: Poliüretan Dökme Conta	Foam Gasket: Polyuterhane Foam
Ön Kapı: 1/2 Noktalı Kilitleme	Front Door: 1/2 Point Locking System
Menteşe: 2/3 Noktadan Gizli Menteşe	Hinges: 2/3 Point Secret Hinges
Kablo Giriş Çıkış: Var	Cable Entry & Outgoing: Available



### ENDÜSTRİYEL TİP TABAN SACLI PANOLAR

YENİ ÜRÜN



ENDÜSTRİYEL SERİ PANOLAR

Ref.No	Pano Ebatları Dimensions	Ağırlık (kg) Weight	Sac Kalınlığı Thickness	Fiyat (TL) Price(TL)	Teslimat Delivery	Açıklama Description
YP 309	250 x 300 x 250 mm		1,5mm	70.00TL	A	<ul style="list-style-type: none"> <li>• Taban saclı panolar.</li> <li>• Giriş-Çıkış için özel contalı kapatma.</li> <li>• Sağa-Sola açılabilir kapı.</li> <li>• Kapı contası poliüretan dökme conta.</li> <li>• Kapı ve gövde topraklama bağlantı yeri.</li> <li>• 1,5mm Sac kalınlığı</li> <li>• IP: 54</li> </ul>
YP 310	300 x 400 x 250 mm		1,5mm	100.00TL	A	
YP 311	400 x 500 x 250 mm		1,5mm	150.00TL	A	
YP 312	400 x 600 x 250 mm		1,5mm	200.00TL	A	
YP 313	500 x 700 x 250 mm		1,5mm	-	Ç	
YP 314	500 x 800 x 250 mm		1,5mm	240.00TL	A	
YP 315	600 x 800 x 250 mm		1,5mm	300.00TL	A	
YP 316	600 x 1000 x 300 mm		1,5mm	400.00TL	A	
YP 317	600 x 1200 x 300 mm		1,5mm	500.00TL	A	
YP 318	800 x 1200 x 300 mm		1,5mm	600.00TL	A	



Teslim Süreleri : ✓ A → Stok Teslim    ✓ B → 3 İş Günü    ✓ C → Sorunuz





### Teknik Detaylar / Technical Details

Konstüksiyon: Kaynaklı Gövde	Construction: Welded Body
Gövde: 1mm/1.5mm Dkp Sac	Body: 1mm/1.5mm Mild Steel
Kapı: 1.2mm Dkp Sac	Door: 1.2mm Mild Steel
Örtü Sacları: 1mm Dkp Sac	Cover Plates: 1mm Mild Steel
Boya: Ral7032 Elektrostatik Toz Boya	Paint: Ral7032 Electrostatic Powder Coating
Koruma Derecesi: IP 41/54	Protection Degree: IP 41/54
Contalama Sist: Poliüretan Dökme Conta	Foam Gasket: Polyurethane Foam
Ön Kapı: 1/2 Noktalı Kilitleme	Front Door: 1/2 Point Locking System
Menteşe: 2/3 Noktadan Gizli Menteşe	Hinges: 2/3 Point Secret Hinges
Kablo Giriş Çıkış: Var	Cable Entry & Outgoing: Available



YP 101



YP 102



YP 103



YP 104



YP 107



YP 106



YP 105

Ref.No	Pano Ebatları Dimensions	Ağırlık (kg) Weight	Fiyat (TL) Price(TL)	Teslimat Delivery	Açıklama Description
YP 101	250 x 300 x 150 mm	5	65TL	B	10 Sigorta Kapasiteli - Pako Yeri
YP 102	300 x 400 x 150 mm	7	90TL	B	20 Sigorta Kapasiteli - Klemens - Pako Yeri
YP 103	400 x 500 x 150 mm	11	130TL	B	30 Sigorta Kapasiteli - Klemens - Pako Yeri
YP 104	400 x 600 x 200 mm	13	165TL	B	45 Sigorta Kapasiteli - Klemens - Pako Yeri
YP 105	500 x 750 x 200 mm	19	200TL	B	60 Sigorta Kapasiteli - Klemens - Pako Yeri
YP 106	600 x 800 x 250 mm	35	340TL	B	100 Sigorta Kapasiteli - Klemens - Pako Yeri
YP 107	600 x 1000 x 300 mm	43	430TL	B	120 Sigorta Kapasiteli - Klemens - Pako Yeri

Teslim Süreleri : ✓ A → Stok Teslim ✓ B → 3 İş Günü ✓ C → Sorunuz

**YP 123**

**YP 125-126**

**YP 124 - 127**

**YP 128**

**YP 129**

**YP 130**
**Teknik Detaylar / Technical Details**

Konstrüksiyon: Kaynaklı Gövde	Construction: Welded Body
Gövde: 1mm/1.5mm	Body: 1mm/1.5mm Mild Steel
Boya: Ral7032 Elektrostatik Toz Boya	Paint: Ral7032 Electrostatic Powder Coating
Koruma Derecesi: IP 41/54	Protection Degree: IP 41/54
Contalama Sist: Polüteran Dökme Canta	Foam Gasket: Polyuterhane Foam

Ref.No	Pano Ebatları Dimensions	Ağırlık (kg) Weight	Fiyat (TL) Price(TL)	Teslimat Delivery	Açıklama Description
YP 123	600 x 1000 x 300 mm	42	350.00TL	C	80 KVAR Kompansasyon
YP 124	400 x 800 x 250 mm	22	175.00TL	C	50 KVAR Kompansasyon
YP 125	400 x 800 x 250 mm	22	253.00TL	C	x/5 Sayaç-Akım Trafosu ve TMS Bölmeli
YP 126	400 x 800 x 250 mm	24	253.00TL	C	30 Sigorta-TMS/Pako + Klemens
YP 127	800 x 800 x 250 mm	40	420.00TL	C	30 Sigorta+TMS/Klemens+60 KVAR Kompansasyon
YP 128	800 x 800 x 250 mm	41	420.00TL	C	x/5 Sayaç - 30 Sigorta + TMS + Klemens
YP 129	1200 x 800 x 250 mm	55	628.00TL	C	x/5 Sayaç - 30 Sigorta + TMS + Klemens + 60 KVAR Kompansasyon
YP 130	1200 x 1000 x 250 mm	65	700.00TL	C	70 Sigorta + TMS + 80 KVAR Kompansasyon
YP 131	1200 x 1000 x 250 mm	67	700.00TL	C	70 Sigorta + TMS +x/5 Sayaç
YP 132	1800 x 1000 x 250 mm	100	1150.00TL	C	70 Sigorta + TMS +x/5 Sayaç + 80 KVAR Kompansasyon

**YP 131**

**YP 132**

Teslim Süreleri : ✓ A → Stok Teslim    ✓ B → 3 İş Günü    ✓ C → Sorunuz



YP 174



YP 173

### Teknik Detaylar / Technical Details

Konstüksiyon: Kaynaklı Gövde	Construction: Fully Modular Not Welded
Gövde: 2mm Galvaniz Sac	Body: 2mm Mild Steel
Kapı: 2mm Galvaniz Sac	Door: 2mm Mild Steel
Boya: Ral7032 Elektrostatik Toz Boya	Paint: Ral7032 Electrostatic Powder Coating
Koruma Derecesi: IP 54/65	Protection Degree: IP 54/65
Contalama Sist: Poliüretan Dökme Conta	
Ön Kapı: 3 Noktalı Kilitleme	Front Door: 3 Point Locking System
Menteşe: 3 Noktadan Gizli Mentşe	Hinges: 4 Point Secret Hinges

Ref.No	Pano Ebatları Dimensions	Ağırlık (kg) Weight	Fiyat (TL) Price(TL)	Teslimat Delivery	Açıklama Description
YP 171	600 x 1100 x 300 mm	50	575.00TL	C	
YP 172	700 x 1400 x 400 mm	75	830.00TL	C	
YP 173	600 x 1400 x 500 mm	75	725.00TL	C	
YP 174	700 x 1800 x 600 mm	100	1000.00TL	C	



YP 172



YP 171

Teslim Süreleri : ✓ A → Stok Teslim ✓ B → 3 İş Günü ✓ C → Sorunuz

**Teknik Detaylar / Technical Details**

Tam etanj (kaynaklı)	Water proof (Welded)
IP64 / IP65 koruma sınıfı	Protection from IP54 upto IP65
Gövde, kapılar 1,2mm 304 kalite paslanmaz sac	Body door's 1,2mm 304 quality
Montaj plakası, 1,2mm pregalvaniz sac	Mounting plate 1,2mm pregalvanized sheet
Ön kapı 135° açılabilir, gizli menteşeli	Front door 135 opening, scot hinges
All-üst fırçalı, kauçuk conta kapamaları	Brushed and foamed gland plates
Proje cebi ön kapı topraklama, ön kapı çerçevesel	A4 diagram pocket, wiring eyebolts, front door earthing screws



	Ref.No	Pano Ebatları Dimensions	Ağırlık (kg) Weight	Fiyat (TL) Price(TL)	Teslimat Delivery	Açıklama Description
	YPPM101	300 x 300 x 200	—	230.00TL	C	
	YPPM102	300 x 400 x 200	—	350.00TL	C	
	YPPM103	400 x 600 x 200	—	575.00TL	C	
	YPPM104	500 x 700 x 200	—	810.00TL	C	
	YPPM105	600 x 800 x 200	—	1050.00TL	C	
	YPPM106	600 x 1000 x 200	—	1150.00TL	C	

	Ref.No	Pano Ebatları Dimensions	Ağırlık (kg) Weight	Fiyat (TL) Price(TL)	Teslimat Delivery	Açıklama Description
	YPPM121	600 x 2060 x 500	125kg	3350.00TL	C	
	YPPM122	700 x 2060 x 500	135kg	3700.00TL	C	
	YPPM123	800 x 2060 x 500	145kg	3900.00TL	C	
	YPPM124	1000 x 2060 x 500	155kg	4400.00TL	C	
	YPPM125	1200 x 2060 x 500	165kg	4600.00TL	C	

Teslim Süreleri : ✓ A → Stok Teslim    ✓ B → 3 İş Günü    ✓ C → Sorunuz



#### Teknik Detaylar / Technical Details

Konstrüksiyon: %100 Modüler Kaynaksız Gövde	Construction: Fully Modular Not Welded
Gövde: 2mm Dkp Sac	Body: 2mm Mild Steel
Kapı: 2mm Dkp Sac	Door: 2mm Mild Steel
Boya: Rai7032 Elektrostatik Toz Boya	Paint: Rai7032 Electrostatic Powder Coating
Koruma Derecesi: IP 41/54	Protection Degree: IP 41/54
Contaklama Stat: Polkürlenmiş Dökme Conta	
Ön Kapı: 3 Noktalı Kilitleme	Front Door: 3 Point Locking System
Montaj: 3 Noktadan Gizli Montaja	Wings: 4 Point Secret Wings



	Ref.No	Pano Ebatları Dimensions	Ağırlık (kg) Weight	Fiyat (TL) Price(TL)	Teslimat Delivery	Açıklama Description
	YP 151	600 x 1300 x 600 mm	80	1270.00TL	C	—
	YP 152	800 x 1300 x 600 mm	105	1725.00TL	C	—
	YP 153	1000 x 1300 x 600 mm	125	2100.00TL	C	—
	YP 154	1200 x 1300 x 600 mm	155	2550.00TL	C	—

	Ref.No	Pano Ebatları Dimensions	Ağırlık (kg) Weight	Fiyat (TL) Price(TL)	Teslimat Delivery	Açıklama Description
	YP 155	600 x 1100 x 500 mm	70	1050.00TL	C	—
	YP 156	800 x 1100 x 500 mm	90	1260.00TL	C	—
	YP 157	1000 x 1100 x 500 mm	115	1600.00TL	C	—

Teslim Süreleri : ✓ A → Stok Teslim ✓ B → 3 İş Günü ✓ C → Sorunuz



Koruma Sınıfı	Kullanım Sahası	Malzeme	Diş Standart	Gövde Boyası	Çelik Malzeme
EEx.d.II.B.T6 IP 54 / 55	GRUPLI sahalarda kullanılır	Alüminyum, ETİAL 140	TSE.61 Whitworth bonu dişli	Gri finn boya	Paslanmaya karşı 20 µ Cadmium kaplanmış çevreler, paslanmaz çelik.



Koruma Sınıfı	Kullanım Sahası	Malzeme	Diş Standart	Gövde Boyası	Çelik Malzeme
EEx.d.II.B.T6 IP 54 / 55	GRUPLI sahalarda kullanılır	Alüminyum, ETİAL 140	TSE.61 Whitworth bonu dişli	Gri finn boya	Paslanmaya karşı 20 µ Cadmium kaplanmış çevreler, paslanmaz çelik.



Koruma Sınıfı	Kullanım Sahası	Malzeme	Diş Standart	Gövde Boyası	Çelik Malzeme
EEx.d.II.B.T6 IP 54 / 55	GRUPLI sahalarda kullanılır	Alüminyum, ETİAL 140	TSE.61 Whitworth bonu dişli	Gri finn boya	Paslanmaya karşı 20 µ Cadmium kaplanmış çevreler, paslanmaz çelik.



Koruma Sınıfı	Kullanım Sahası	Malzeme	Diş Standart	Gövde Boyası	Çelik Malzeme
EEx.d.II.B.T6 IP 54 / 55	GRUPLI sahalarda kullanılır	Alüminyum, ETİAL 140	TSE.61 Whitworth bonu dişli	Gri finn boya	Paslanmaya karşı 20 µ Cadmium kaplanmış çevreler, paslanmaz çelik.



Koruma Sınıfı	Kullanım Sahası	Malzeme	Diş Standart	Gövde Boyası	Çelik Malzeme
EEx.d.II.B.T6 IP 54 / 55	GRUPLI sahalarda kullanılır	Alüminyum, ETİAL 140	TSE.61 Whitworth bonu dişli	Gri finn boya	Paslanmaya karşı 20 µ Cadmium kaplanmış çevreler, paslanmaz çelik.



Koruma Sınıfı	Kullanım Sahası	Malzeme	Diş Standart	Gövde Boyası	Çelik Malzeme
EEx.d.II.B.T6 IP 54 / 55	GRUPLI sahalarda kullanılır	Alüminyum, ETİAL 140	TSE.61 Whitworth bonu dişli	Gri finn boya	Paslanmaya karşı 20 µ Cadmium kaplanmış çevreler, paslanmaz çelik.

Ürün bilgileri için lütfen satış birimimiz ile irtibata geçiniz.



# **NET-RACK**

**Data Sistemlerinde  
Çözüm Ortağınız**



### Teknik Detaylar / Technical Details

19" e Uygun Tüm Donatıları Kolay Montaj	Easy for Assembling All 19" Products
Hareketli Tekerlek Yapısı (2 Sabit - 2 Tam Döner)	Sliding Castor Built (2 Fixed - 2 Fullturn)
Geniş Ölçü Seçeneği	Wide Dimension Option
Tam Modüler ve Estetik Yapı	Full Modular and Esthetic Metal Structure
2mm Sac Kalınlığı ile Yüksek Dayanıklılık	High strength with 2mm metal thickness
Siyah Elektrostatik Toz Boyak	Black Electrostatic Powder Coating
Ön Kapak 5mm Temperli Cam	Front Tempered Glassed Door 5mm
Uygun Fiyat ve Kullanım Kolaylığı	Suitable Price and Easy Application



Ref.No	Ebatlar Dimensions	Ağırlık (kg) Weight	Fiyat (TL) Price(TL)	Teslimat Delivery
<b>G x D : 600 x 600</b>				
LR2066	20U 19" 600 x 1000 x 600mm	59	555.00TL	A
LR2466	24U 19" 600 x 1240 x 600mm	66	650.00TL	A
LR2866	28U 19" 600 x 1440 x 600mm	73	760.00TL	A
LR3266	32U 19" 600 x 1600 x 600mm	81	810.00TL	A
LR3666	36U 19" 600 x 1770 x 600mm	88	940.00TL	A
LR4066	40U 19" 600 x 1950 x 600mm	94	1010.00TL	A
LR4266	42U 19" 600 x 2040 x 600mm	97	1150.00TL	A
<b>G x D : 600 x 800</b>				
LR2468	24U 19" 600 x 1240 x 800mm	80	760.00TL	A
LR2868	28U 19" 600 x 1440 x 800mm	90	810.00TL	A
LR3268	32U 19" 600 x 1600 x 800mm	95	890.00TL	A
LR3668	36U 19" 600 x 1770 x 800mm	100	1010.00TL	A
LR4068	40U 19" 600 x 1950 x 800mm	110	1090.00TL	A
LR4268	42U 19" 600 x 2040 x 800mm	115	1270.00TL	A
<b>G x D : 800 x 800</b>				
LR3688	32U 19" 800 x 1600 x 800mm	110	980.00TL	A
LR4088	36U 19" 800 x 1770 x 800mm	120	1056.00TL	A
LR4288	42U 19" 800 x 2040 x 800mm	130	1380.00TL	A



Teslim Süreleri : ✓ A → Stok Teslim ✓ B → 3 İş Günü ✓ C → Sorunuz

### Aksesuar Seçenekleri

Kabin dahil aksesuarları:

- \*5mm 5mm Temperli camlı ön kapı
- \*Sökülebilir arka ve yan kapaklar
- \*2 Frezli - 2 Döner tekerlek grubu
- \*19" Cihaz montaj dikmeleri
- \*Cihaz Montaj Video Seti (1 set - 25 Adet)

Kabin hariç aksesuarları; (Sayfa .... bkt)

- \*Sabit & Hareketli Raf
- \*Fan Modülü
- \*19" Alın Fırız Grubu
- \*Kablo Düzenleyici
- \*Aktif & Pasif cihazlar



### Teknik Detaylar / Technical Details

19"e Uygun Tüm Cihazların Kolay Montajı	Easy for Assembling All 19" Products
Hareketli Tekerlek Yapısı (2 Sabit - 2 Tam Dönüş)	Sliding Castor Build (2 fixed - 2 Fullturn)
Geniş Ölçü Seçeneği	Wide Dimension Option
Tam Modüler ve Estetik Yapı	Full Modular and Esthetic Metal Structure
2mm Sac Kalınlığı ile Yüksek Dayanıklılık	High strength with, 2mm metal thickness
Siyah Elektrostatik Toz Boyalı	Black Electrostatic Powder Coating
Ön Kapak 5mm Temperli Cam	Front Tempered Glassed Door 5mm
Uygun Fiyat ve Kullanım Kolaylığı	Suitable Price and Easy Application

### SERVER RACK KABİN

Ref.No	Ebatlar Dimensions	Ağırlık (kg) Weight	Fiyat (TL) Price(TL)	Teslimat Delivery
<b>G &amp; D : 600 x 1000</b>				
SK3261	32U 19" 600 x 1600 x 1000 mm		1000.00TL	A
SK3661	36U 19" 600 x 1770 x 1000 mm		1040.00TL	A
SK4261	42U 19" 600 x 2040 x 1000 mm		1320.00TL	A
<b>G &amp; D : 800 x 1000</b>				
SK3281	32U 19" 800 x 1600 x 1000 mm		1320.00TL	A
SK3681	36U 19" 800 x 1770 x 1000 mm		1480.00TL	A
SK4281	42U 19" 800 x 2040 x 1000 mm		1640.00TL	A



### PC RACK KABİN

Ref.No	Ebatlar Dimensions	Ağırlık (kg) Weight	Fiyat (TL) Price(TL)	Teslimat Delivery
<b>G &amp; D : 600 x 600</b>				
PC3266	32U 19" 600 x 1600 x 600 mm		920.00TL	A
PC3666	36U 19" 600 x 1770 x 600 mm		1060.00TL	A
PC4266	42U 19" 600 x 2040 x 600 mm		1320.00TL	A
<b>G &amp; D : 600 x 800</b>				
PC3268	32U 19" 600 x 1600 x 800 mm		980.00TL	A
PC3668	36U 19" 600 x 1770 x 800 mm		1060.00TL	A
PC4268	42U 19" 600 x 2040 x 800 mm		1300.00TL	A



Teslim Süreleri : ✓ A → Stok Teslim    ✓ B → 3 İş Günü    ✓ C → Sorunuz

### Aksesuar Seçenekleri

Kabin dahili aksesuarları;

- \*Füme 5mm Temperli camlı ön kapı
- \*Sökülebilir arka ve yan kapaklar
- \* 2 Frenli - 2 Döner tekerlek grubu
- \* 19" Cihaz montaj dikmeleri
- \*Cihaz Montaj Vida Seti (1 set - 25 Adet)

Kabin harici aksesuarları; (Sayfa .... bkz)

- \*Sabit & Hareketli Raf
- \* Fan Modülü
- \*19" Alm Priz Grubu
- \* Kablo Düzenleyici
- \* Aktif & Pasif cihazlar



### Teknik Detaylar / Technical Details

19" e Uygun Tüm Cihazların Kolay Montajı	Easy for Assembling All 19" Products
Tam Modüler ve Estetik Yapı	Fully Modular and Esthetic Metal Structure
1/1.5mm Sac Kalınlığı ile Yüksek Dayanıklılık	High strength with, 1/1.5mm metal thickness
Siyah Elektrostatik Toz Boyalı	Black Electrostatik Powder Coating
Ön Kapak 5mm Temperli Cam	Front Tempered Glassed Door 5mm
Uygun Fiyat ve Kullanım Kolaylığı	Suitable Price and Easy Application
Geniş Ölçü Seçeneği	Wide Dimension Option



### DUVAR TİPİ KABİN

Ref.No	Ebatlar Dimensions	Ağırlık (kg) Weight	Fiyat (TL) Price(TL)	Teslimat Delivery
<b>G &amp; D : 600 x 450</b>				
SR764	7U 19" 600 x400 x450 mm	16	250.00TL	A
SR964	9U 19" 600 x480 x450 mm	18	265.00TL	A
SR1264	12U 19" 600 x610 x450 mm	22	280.00TL	A
SR1664	16U 19" 800 x800 x450 mm	40	360.00TL	A
<b>G &amp; D : 600 x 600</b>				
SR766	7U 19" 600 x400 x600 mm	25	270.00TL	A
SR966	9U 19" 600 x480 x600 mm	30	290.00TL	A
SR1266	12U 19" 600 x610 x600 mm	35	315.00TL	A
SR1666	16U 19" 600 x800 x600 mm	40	380.00TL	A



### MINİ TİP KABİN

Ref.No	Ebatlar Dimensions	Ağırlık (kg) Weight	Fiyat (TL) Price(TL)	Teslimat Delivery
<b>G &amp; D : 540 x 450</b>				
MR754	7U 19" 540 x330 x450 mm	13	140.00TL	A
MR954	9U 19" 540 x420 x450 mm	15	150.00TL	A
MR1254	12U 19" 540 x550 x450 mm	19	175.00TL	A
<b>G &amp; D : 540 x 600</b>				
MR756	7U 19" 540 x330 x600 mm	20	165.00TL	A
MR956	9U 19" 540 x420 x600 mm	25	175.00TL	A
MR1256	12U 19" 540 x550 x600 mm	30	200.00TL	A



Teslim Süreleri : ✓ A → Stok Teslim ✓ B → 3 İş Günü ✓ C → Sorunuz

### Aksesuar Seçenekleri

Kabin dahili aksesuarları;

- \*Füme 5mm Temperli camlı ön kapı
- \*Sökülebilir arka ve yan kapaklar
- \*19" Cihaz montaj dikmeleri

Kabin harici aksesuarları; (Sayfa .... bkz)

- \*Sabit & Hareketli Raf
- \* Fan Modülü
- \*19" Alm Priz Grubu
- \* Kablo Düzenleyici
- \* Aktif & Pasif cihazlar

	Ref.No	Ürün İçeriği Product Content	Fiyat (TL) Price(TL)
 <p>Sabit Raf / Fixed Shelf</p>	<b>SABİT RAF</b>		
	SR101	600 x 600 mm Sabit Raf	37.00TL
	SR102	800 x 600 mm Sabit Raf	40.00TL
	SR103	600 x 1000 mm Sabit Raf	45.00TL
	MSR101	540 x 450 mm Sabit Raf 19"	34.00TL
	MSR102	540 x 600 mm Sabit Raf 19"	36.00TL
 <p>Hareketli Raf / Sliding Shelf</p>	<b>HAREKETLİ RAF</b>		
	HR101	600 x 600 mm Hareketli Raf	55.00TL
	HR102	600 x 800 mm Hareketli Raf	65.00TL
	HR103	600 x 1000 mm Hareketli Raf	80.00TL
 <p>Priz Modülleri / Blacks Panels</p>	<b>PRİZ MODÜLLERİ</b>		
	PM100	3'lü Alm Priz Modülü (16A Sigortalı)	50.00TL
	PM101	6'lı Alm Priz Modülü (16A Sigortalı)	65.00TL
	PM102	8'li Alm Priz Modülü	75.00TL
	PM103	9'lu Alm Priz Modülü	85.00TL
 <p>Fan Modülü / Fan Modules</p>	<b>FAN MODÜLLERİ</b>		
	FM100	1'li Fan ve Termostat Modülü	100.00TL
	FM101	2'li Fan ve Termostat Modülü	120.00TL
	FM102	4'lü Fan ve Termostat Modülü	200.00TL
	FM103	6'lı Fan ve Termostat Modülü	275.00TL
	FM-DT1	Digital Termostat 0-40C	200.00TL
 <p>Kablo Düzenleyici / Cable Organizer</p>	<b>KABLO DÜZENLEYİCİLER</b>		
	KD101	19" 1U Yatay Kablo Düzenleyici	14.00TL
	KD102	19" 2U Yatay Kablo Düzenleyici	19.00TL
	KD103	19" 4U Yatay Kablo Düzenleyici	23.00TL
	KD104	19" 32U Dikey Kablo Düzenleyici	165.00TL
	KD105	19" 36U Dikey Kablo Düzenleyici	175.00TL
	KD106	19" 42U Dikey Kablo Düzenleyici	200.00TL
 <p>Kızak</p>	<b>KIZAK RAYI</b>		
	KZ101	Kızak Rayı (1 Takım) 35mm	20.00TL
	KZ102	Kızak Rayı (1 Takım) 45mm	25.00TL

Teslim Süreleri : ✓ A → Stok Teslim    ✓ B → 3 İş Günü    ✓ C → Sorunuz

	Ref.No	Ürün İçeriği Product Content	Fiyat (TL) Price(TL)
 <p>Kapama Modülü / Black Panels</p>	<b>KAPAMA PANELİ</b>		
	KP101 KP102 KP103	19" 1U Yatay Kapama Paneli 19" 2U Yatay Kapama Paneli 19" 4U Yatay Kapama Paneli	8.00TL 14.00TL 16,5TL
 <p>Tekerlek Grubu / Castor Group</p>	<b>TEKERLEK GRUBU</b>		
	TG101 TG102 TG103	2 Frenli - 2 Döner Tekerlek Grubu 4 Hareketli Tekerlek Grubu 4 Sabit Ayak Grubu	60.00TL 60.00TL 60.00TL
 <p>Patch Panel</p>	<b>PATCH PANEL</b>		
	PP245 PP246 PP485 PP486 TP50	24 Port Patch Panel Cat-5 24 Port Patch Panel Cat-6 48 Port Patch Panel Cat-5 48 Port Patch Panel Cat-6 50 Port Telefon Paneli	75.00TL 125.00TL 160.00TL 250.00TL 240.00TL
 <p>Cat5/6 Data Kablosu Cat5/6 Data Cable</p>	<b>DATA KABLolari</b>		
	PC505 PC510 PC520 PC530 PC505 PC610 PC620 PC630	Cat5 Patch Cord (0,6mt) Cat5 Patch Cord (1mt) Cat5 Patch Cord (2mt) Cat5 Patch Cord (3mt) Cat6 Patch Cord (0,6mt) Cat6 Patch Cord (1mt) Cat6 Patch Cord (2mt) Cat6 Patch Cord (3mt)	3.00TL 3.40TL 4.30TL 6.00TL 7.20TL 9.00TL 6.50TL 10.80TL
 <p>Yardımcı Aksesuar</p>	<b>YARDIMCI AKSESUAR</b>		
	KSF625 KSF650  YPA29-1 YPA29-2  TK615	M6 Kare Somun, Vida, Pul (25Ad) M6 Kare Somun, Vida, Pul (50Ad)  9'lu Vidalı Toprak Barası 15'li Vidalı Toprak Barası  6mm Sarı-Yeşil Toprak Kablosu	25.00TL 50.00TL  2.00TL 6.00TL  5.00TL

Teslim Süreleri : ✓ A → Stok Teslim    ✓ B → 3 İş Günü    ✓ C → Sorunuz

# **Yplastico**<sup>®</sup>

*Kanalet sistemleri çözüm ortağınız*



**Yplastico** kablo kanallarını diğer metal kablo kanallarıyla kıyaslandığında daha dayanıklı olduğunu hem gözle, hem de test ederek görmek mümkündür. Plastica A.G enerji kablolarından, zayıf akım kablolarına, Data kablolarından, fiber optik kablolara kadar geniş bir yelpazede kablo taşımaya olanak sağlamaktadır. Bu kabloların taşınması esnasında kablo cinsine göre kanalların renkleri değişebilmekte, buda kullanıcıya nerede, hangi sistem için, hangi kablo islenmiş gibi bir bilgiye ulaşmasına olanak sağlamaktadır.

**Teknik Detaylar / Technical Details**

Saca Göre Dayanıklılık	<i>More Resistant With Other Metal Cable Channels</i>
Paslanmaz ve Çürüme Olmaz	<i>Rust and Rot Rover Time</i>
UV Katkısıyla Renk Değişimi Olmaz	<i>UV Additive, No Subject To Color Changes</i>
Kolay Montaj Sağlar	<i>Use and Installation is Easy and Saves Times Too</i>
Plastik Yapı, Oluşabilecek Kısa Devreleri Bertaraf Edebilmektedir	<i>Is Not Conductive Due To Faulire, Due To Leakage Current Installation Doesn't Transmit an Extremely Safe</i>
İşlevsellik ve Estetik Yapısı Tercih Sebebidir	<i>Provides Adaptation To The Environment</i>
	<i>The Functionality and Aesthetics Come Together</i>

Ref.No	Genişlik x Derinlik x Kalınlık Width x Depth x Thickness	Ağırlık (kg) Weight	Ambalaj Package	Fiyat (TL/m) Price (TL/m)
<b>KABLO TAVASI</b>				
YPC 2410	100 x 50 x 3	Beyaz 1,415	10m	11.00TL
YPC 2415	150 x 70 x 3	Beyaz 1,913	10m	15.50TL
YPC 2420	200 x 100 x 3	Beyaz 2,810	10m	23.00TL
<b>TAVA KAPAĞI</b>				
YPC 2410 KK	100 x 3	Beyaz 0,524	10m	3.85TL
YPC 2415 KK	150 x 3	Beyaz 0,760	10m	6.10TL
YPC 2420 KK	200 x 3	Beyaz 0,910	10m	7.00TL



Notlar: Standart renk beyazdır. Farklı renkler için satış birimlerimiz ile görüşünüz.

Özel boyalarda kanal yapılmaktadır (2,50m, 3,00m, 3,50m).

Notes: For special order we can manufacture different color's. Channel length standart 2 meter.

We can manufacture special length's (2,50m, 3,00m, 3,50m)



Ref.No	Genişlik x Derinlik x Kalınlık Width x Depth x Thickness	Ağırlık (kg) Weight	Ambalaj Package	Fiyat (TL) Price (TL)
<b>YATAY DÖNÜŞ</b>				
YPC 2410 YD	100 x 50 x 3	0,140	10 Adet	5.60TL
YPC 2415 YD	150 x 70 x 3	0,280	10 Adet	7.50 TL
YPC 2420 YD	200 x 100 x 3	0,530V	10 Adet	11.00TL
<b>KAPAK</b>				
YPC 2410 YD-K	100 x 3	—	10 Adet	Sorunuz
YPC 2415 YD-K	150 x 3	—	10 Adet	Sorunuz
YPC 2420 YD-K	200 x 3	—	10 Adet	Sorunuz

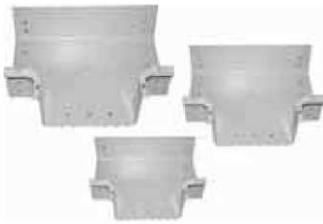

Ref.No	Genişlik x Derinlik x Kalınlık Width x Depth x Thickness	Ağırlık (kg) Weight	Ambalaj Package	Fiyat (TL) Price (TL)
<b>T DÖNÜŞ</b>				
YPC 2410 TD	100 x 50 x 3	0,188	10 Adet	7.80TL
YPC 2415 TD	150 x 70 x 3	0,360	10 Adet	9.80TL
YPC 2420 TD	200 x 100 x 3	0,580	10 Adet	12.40TL
<b>KAPAK</b>				
YPC 2410 TD-K	100 x 3	—	10 Adet	Sorunuz
YPC 2415 TD-K	150 x 3	—	10 Adet	Sorunuz
YPC 2420 TD-K	200 x 3	—	10 Adet	Sorunuz



Ref.No	Genişlik x Derinlik x Kalınlık Width x Depth x Thickness	Ağırlık (kg) Weight	Ambalaj Package	Fiyat (TL) Price (TL)
<b>4'LÜ BAĞLANTI</b>				
YPC 2410 DB	100 x 50 x 3	0,210	10 Adet	9.00TL
YPC 2415 DB	150 x 70 x 3	0,400	10 Adet	12.00TL
YPC 2420 DB	200 x 100 x 3	0,600	10 Adet	13.00TL
<b>KAPAK</b>				
YPC 2410 DB-K	100 x 3	—	10 Adet	Sorunuz
YPC 2415 DB-K	150 x 3	—	10 Adet	Sorunuz
YPC 2420 DB-K	200 x 3	—	10 Adet	Sorunuz



Ref.No	Genişlik x Derinlik x Kalınlık Width x Depth x Thickness	Ağırlık (kg) Weight	Ambalaj Package	Fiyat (TL) Price (TL)
<b>İÇ-DIŞ BÜKEY</b>				
YPC 2410 İÇB	100 x 3	0,080	10 Adet	4.10TL
YPC 2415 İÇB	150 x 3	0,200	10 Adet	6.00TL
YPC 2420 İÇB	200 x 3	0,270	10 Adet	8.10TL
YPC 2410 DİB	100 x 3	0,080	10 Adet	4.10TL
YPC 2415 DİB	150 x 3	0,200	10 Adet	6.00TL
YPC 2420 DİB	200 x 3	0,270	10 Adet	8.10TL



Ref.No	Genişlik x Derinlik x Kalınlık Width x Depth x Thickness	Ağırlık (kg) Weight	Ambalaj Package	Fiyat (TL) Price (TL)
<b>REDÜKSİYON</b>				
YPC 2410 RD	150 -100 x 50 x 3	0,145	10 Adet	9.00TL
YPC 2415 RD	200-150 x 70 x 3	0,285	10 Adet	12.00TL
<b>KAPAK</b>				
YPC 2410 RD-K	200 - 100 x 3	—	10 Adet	Sorunuz
YPC 2415 RD-K	200 - 150 x 3	—	10 Adet	Sorunuz



Ref.No	Genişlik x Derinlik x Kalınlık Width x Depth x Thickness	Ağırlık (kg) Weight	Ambalaj Package	Fiyat (TL) Price (TL)
<b>BİRLEŞTİRME ELEMANI</b>				
YPC 2410 EK	100 x 50 x 3	0,080	20 Adet	1.60TL
YPC 2415 EK	150 x 70 x 3	0,155	20 Adet	2.75TL
YPC 2420 EK	200 x 100 x 3	0,240	20 Adet	4.00TL



Notlar: Standart renk beyazdır. Farklı renkler için satış birimlerimiz ile görüşünüz.

Özel boyalarda kanal yapılmaktadır (2,50m, 3,00m, 3,50m).

Notes: For special order we can manufacture different color's. Channel length standart 2 meter.

We can manufacture special length's (2,50m, 3,00m, 3,50m)





Ref.No	Genişlik x Derinlik Width x Depth	Ağırlık (kg) Weight	Ambalaj Package	Fiyat (TL/m) Price (TL/m)
<b>ASKI TAŞIYICI</b>				
YPC 2410 AT	100'lük Taşıyıcı	0,050	10 Adet	1.50TL
YPC 2415 AT	150'lik Taşıyıcı	0,105	10 Adet	2.10TL
YPC 2420 AT	200'lük Taşıyıcı	0,190	10 Adet	3.20TL



Ref.No	Genişlik x Derinlik Width x Depth	Ağırlık (kg) Weight	Ambalaj Package	Fiyat (TL/m) Price (TL/m)
<b>DUVAR TAŞIYICI</b>				
YPC 2410 DT	100 x 100	0,24	10 Adet	3.00TL
YPC 2415 DT	160 x 100	0,32	10 Adet	3.60TL
YPC 2420 DT	210 x 100	0,42	10 Adet	4.10TL



Ref.No	Genişlik x Derinlik Width x Depth	Ağırlık (kg) Weight	Ambalaj Package	Fiyat (TL/m) Price (TL/m)
<b>C TİP TAŞIYICI</b>				
YPC 2410 CT	100'lük C Taşıyıcı	0,216	10 Adet	3.20TL
YPC 2415 CT	150'lik C Taşıyıcı	0,262	10 Adet	3.80TL
YPC 2420 CT	200'lük C Taşıyıcı	0,328	10 Adet	4.60TL



Ref.No	Uzunluk Leight	Ağırlık (kg) Weight	Ambalaj Package	Fiyat (TL/m) Price (TL/m)
<b>ASKI TİJLERİ</b>				
YPC 8*1000	1000	0,298	10 Adet	2.50TL
YPC 8*2000	2000	0,596	10 Adet	5.00TL
YPC 10*1000	1000	0,4	10 Adet	5.00TL
YPC 10*2000	2000	0,8	10 Adet	10.00TL



Ref.No	Tip Type	Ağırlık (kg) Weight	Ambalaj Package	Fiyat (TL/m) Price (TL/m)
<b>DÜBEL-VİDA-SOMUN</b>				
YPC 01	M8 Çakmalı Tip	0,012		0.36TL
YPC 02	M8 Çekmeli Tip	0,014		0.58TL
YPC 03	M8 Somun	0,12		0.07TL
YPC 04	M10 Somun	0,21		0.15TL
YPC 05	Bağlantı Civata Takımı	0,01		0.45TL

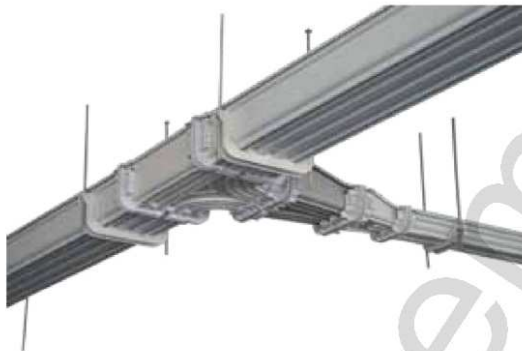
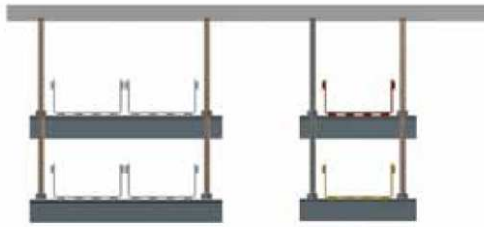
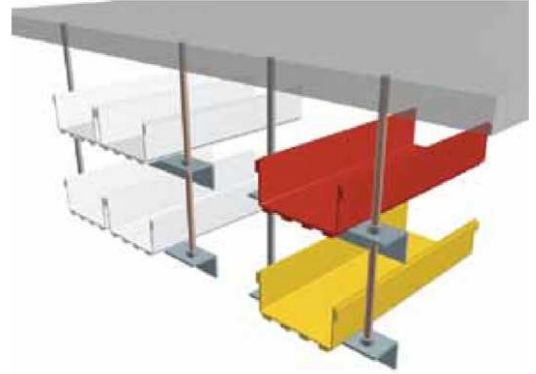
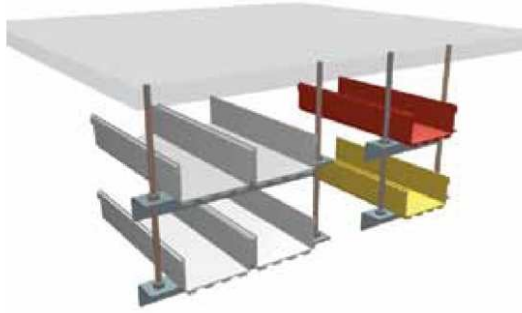



**VIZ Light**  
Aydınlatma Sistemleri



POLYESTER GÖVDELİ ve CADDE ARMATÜRLERİ  
POLYESTER BODY ROAD AND STREET LUMINAIRES

**S1 YOL ve CADDE ARMATÜRÜ**  
POLYESTER GÖVDELİ  
POLYESTER BODY and STREET LUMINAIRES  
Max. 50W-150W

Kod No Code No	Güç Power	Ağırlık	Koli/Adet Packing/Unit	Ölçüler Dimension	Fiyat Price
YL B150	BOŞ	2,07kg	1	515 X250X 160	30.00TL
YL S150	150W SODYUM	2,07kg	1	515 X250X 160	82.00TL

**S2 YOL ve CADDE ARMATÜRÜ**  
POLYESTER GÖVDELİ  
POLYESTER BODY and STREET LUMINAIRES  
Max. 150W-250W

Kod No Code No	Güç Power	Ağırlık	Koli/Adet Packing/Unit	Ölçüler Dimension	Fiyat Price
YL B250	BOŞ	2,60kg	1	555 X325X 265	40.00TL
YL SM150	150W SODYUM/METAL	2,60kg	1	555 X325X 265	85.00TL
YL S250	250W SODYUM/BUHARLI	2,60kg	1	555 X325X 265	90.00TL
YL C250	250W CIVA/BUHARLI	2,60kg	1	555 X325X 265	80.00TL

**S3 YOL ve CADDE ARMATÜRÜ**  
POLYESTER GÖVDELİ  
POLYESTER BODY and STREET LUMINAIRES  
Max. 400W

Kod No Code No	Güç Power	Ağırlık	Koli/Adet Packing/Unit	Ölçüler Dimension	Fiyat Price
YL B400	BOŞ	5,90kg	1	710 X330X 225	50.00TL
YL M400	400W SODYUM/METAL	5,90kg	1	710 X330X 225	130.00TL
YL S400	400W SODYUM/BUHAR	5,90kg	1	710 X330X 225	130.00TL



YL 1005 P	SOKAK ARMATÜRÜ DİREĞİ				6.50TL
-----------	-----------------------	--	--	--	--------

**KULLANIM ALANLARI**  
AREAS OF USE

Otobanlar  
Caddeler,  
Sokaklar,  
Bahçeler,  
Parklar,  
Yaya geçitleri,

Highways,  
The Streets,  
Streets,  
Gardens,  
Parks,  
The pedestrian crossings,

ALÜMİNYUM GÖVDELİ ve CADDE ARMATÜRLERİ  
ALUMINIUM BODY ROAD AND STREET LUMINAIRES

YOL ve CADDE ARMATÜRÜ  
ALÜMİNYUM GÖVDELİ  
ALUMINIUM BODY and STREET LUMINAIRES  
IP 65 Max. 150W

Kod No Code No	Güç Power	Ağırlık	Koli/Adet Packing/Unit	Ölçüler Dimension	Fiyat Price
YL S9006	70-150W SODYUM	3,90kg	1	530 X240X235	100.00TL
YL S9006	125W CIVA	3,90kg	1	530 X240X235	100.00TL

YOL ve CADDE ARMATÜRÜ  
ALÜMİNYUM GÖVDELİ  
ALUMINIUM BODY and STREET LUMINAIRES  
IP 65 Max. 250W

Kod No Code No	Güç Power	Ağırlık	Koli/Adet Packing/Unit	Ölçüler Dimension	Fiyat Price
YL S9005	250W SODYUM	2,40kg	1	630 X240X285	110.00TL
YL S9005	250W CIVA	2,40kg	1	630 X240X285	110.00TL

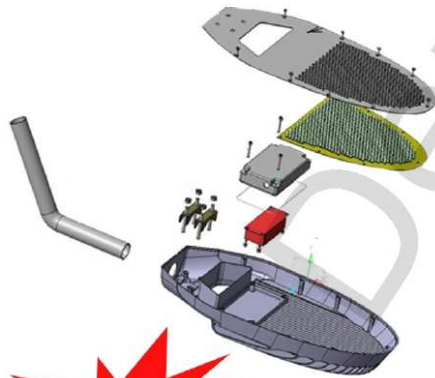
LEDLİ SOKAK ARMATÜRÜ  
ALÜMİNYUM GÖVDELİ  
ALUMINIUM BODY and STREET LUMINAIRES  
IP 65 Max. 250W

Kod No Code No	Güç Power	Ağırlık	Koli/Adet Packing/Unit	Ölçüler Dimension	Fiyat Price
LDS101	583 x 367mm	-	-	-	-

YENİ ÜRÜN

KULLANIM ALANLARI  
AREAS OF USE

Otobanlar  
Caddeler,  
Sokaklar,  
Bahçeler,  
Parklar,  
Yaya geçitleri,

Highways,  
The Streets,  
Streets,  
Gardens,  
Parks,  
The pedestrian crossings,

ETANJ ARMATÜRLER  
WATERPROOF LUMINAİRES



1 x 18 Etanj Armatür

YL E - 118



1 x 36 Etanj Armatür

YL E - 136

KULLANIM ALANLARI  
AREAS OF USE

Otobanlar  
Caddeler,  
Sokaklar,  
Bahçeler,  
Parklar,  
Yaya geçitleri,  
Highways,  
The Streets,  
Streets,  
Gardens,  
Parks,  
The pedestrian crossings,

YARDIMCI AKSESUARLAR

Balast : Manyetik veya elektronik / *Magnetic or electronic*  
Gövde : Polyester / *PC*  
Lamba : TL D-18w, 36w / *TL D-18w, 36w*

ETANJ ARMATÜRLER  
 WATERPROOF LUMINAIRES

2 x 18 Etanj Armatür

YL E - 218



2 x 36 Etanj Armatür

YL E - 236

 ETANJ ARMATÜRLER  
 WATERPROOF LUMINAIRES

Kod No Code No	Güç Power	Ağırlık	Koli/Adet Packing/Unit	Ölçüler Dimension	Fiyat Price
YL E118	TL- D 1x18	1,62 kg	2	675x205x100	25.00TL
YL E218	TL- D 2x18	1,80 kg	2	675x300x100	32.00TL
YL E136	TL- D 1x36	2,25 kg	2	1200x210x100	35.00TL
YL E236	TL- D 2x36	3,44 kg	2	1200x310x100	45.00TL

ETANJ DUYLU BANT ARMATÜRLER  
FIBERGLASS and BATTEN LUMINAIRES WITH IP65 LAMP HOLDERS



1 x 36 Etanj Buylu Bant Armatür

YL E - 136



2 x 36 Etanj Buylu Bant Armatür

YL TE - 236

ETANJ ARMATÜRLER  
WATERPROOF LUMINAIRES

Kod No Code No	Güç Power	Ağırlık	Koli/Adet Packing/Unit	Ölçüler Dimension	Fiyat Price
YL TE136	TL- D 1x 36	2,10 kg	2	1260 x 135 x 80	18.00TL
YL TE236	TL- D 2x 36	3,00 kg	2	1260 x 150 x 130	30.00TL



**PROJEKTÖRLER**  
**FLOODLIGHTS**  
**POLYESTER - BODIED PROJECTORS**  
**POLYESTER - BODIED PROJECTORS**



**POLYESTER GÖVDELİ PROJEKTÖR**  
**POLYESTER-BODIED PROJECTORS**  
**Max. 400W IP65**

Kod No Code No	Güç Power	Ağırlık	Koli/Adet Packing/Unit	Ölçüler Dimensions	Fiyat Price
YL B400	400W E27 DUYLU BOŞ	6,25 kg	1	445x435x150	50.00TL
YL B401	400W E40 DUYLU BOŞ	6,25 kg	1	445x435x150	52.00TL
YL M400	400W METAL HALİDE	6,25 kg	1	445x435x150	115.00TL
YL S250	250W SODYUM	6,25 kg	1	445x435x150	125.00TL
YL M250	250W METAL HALİDE	6,25 kg	1	445x435x150	115.00TL



**POLYESTER GÖVDELİ PROJEKTÖR**  
**POLYESTER-BODIED PROJECTORS**  
**Max. 1000W IP65**

Kod No Code No	Güç Power	Ağırlık	Koli/Adet Packing/Unit	Ölçüler Dimensions	Fiyat Price
YL B1000	1000W E40 DUYLU BOŞ		1		280.00TL
YL M1000	1000W METAL HALİDE		1		400.00TL
YL S1000	1000W SODYUM		1		400.00TL

Satış Birimlerimize Sorunuz.

**KULLANIM ALANLARI**  
**AREAS OF USE**

Cephe aydınlatmaları,  
 Bahçeler,  
 Vitrinler,  
 Fuar ve sergiler,  
 Spor salonları,  
 Reklam panoları,  
 Tüneller,

Wall Lighting,  
 Gardens,  
 Showcases,  
 Fair and exhibitions,  
 Sports Halls,  
 Billboards,  
 Tunnels,

**ATÖLYE TİPİ ARMATÜRLER**  
**INDUSTRIAL TYPE LIGHTING LUMINAIRES**  
**ENDÜSTRİYEL TİP - POLYESTER BAŞLI - HDK TİP**  
**INDUSTRIAL TYPE - POLYESTER HEAD - HDK TYPE**



**ENDÜSTRİYEL TİP DAHİLİ ARMATÜR**  
**INDUSTRIAL TYPE LIGHTING LUMINAIRES**



**POLYESTER BAŞLI**  
**ENDÜSTRİYEL DAHİLİ ARMATÜR**  
**INDUSTRIAL TYPE LIGHTING**  
**LUMINAIRES WITH POLYESTER HEAD**



**HDK ENDÜSTRİYEL TİP**  
**DAHİLİ ARMATÜR**  
**HDK INDUSTRIAL TYPE INTERNAL**  
**LIGHTING LUMINAIRES**

Kod No Code No	Cinsi Type	Ölçüler Dimensions	Fiyat Price
YL 1005A	GÖVDE + E27 DUY	410 x 250	36.00TL
YL 1005B	GÖVDE + KAİDE + POLYESTER BAŞLIK + E27 DUY	410 x 420	66.00TL
YL 1005C	GÖVDE + KAİDE + POLYESTER BAŞLIK + E40 DUY	410 x 420	64.80TL
YL 1005D	GÖVDE + HDK + E27 DUY	410 x 390	99.60TL
YL 1005E	GÖVDE + HDK + E40 DUY	410 x 390	98.40TL

**KULLANIM ALANLARI**  
**AREAS OF USE**

Yüksek tavana sahip sanayi tesisleri,  
 Depolar,  
 Kapalı Spor Salonları,  
 Alışveriş Merkezleri,  
 Spor salonları,  
 Süper Marketler,

Industrial facilities with high ceiling,  
 Warehouses,  
 Indoor Sports Halls,  
 Shopping Centers,  
 Sports Halls,  
 Supermarkets,

**AKSESUARLAR**

**E - 40 DUY**

**E - 27 DUY**

**E - 27 KAİDELI DUY**

**E - 40 DUYLU KAİDE**

**POLYESTER BAŞLIK**

**ARMATÜR KOVASI**

**HDK**

**20W-40W Balast**

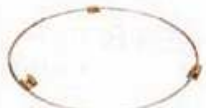
**CAM**

**TEL MONTAJ APARATI**

**TEL KAFES**

**SOKAK ARMATÜRÜ DİREĞİ**

Kod No Code No	Cinsi Type	Ölçüler Dimensions	Fiyat Price
YL 1005F	E40 DUYLU KAİDE	0,55 Kg	16.00TL
YL 1005G	E27 DUYLU KAİDE	0,32 Kg	12.00TL
YL 1005H	E40 DUY	0,10 Kg	12.00TL
YL 1005I	E27 DUY	0,085 Kg	8.00TL
YL 1005J	CAM	1,1 Kg	15.00TL
YL 1005K	TEL KAFES	-	15.00TL
YL 1005L	CAM MONTAJ APARATI	-	10.00TL
YL 1005M	POLYESTER KAFA	-	32.50TL
YL 1005N	HDK	-	40.80TL
YL 1005O	ARMATÜR KOVASI	-	17.00TL
YL 1005P	SOKAK ARMATÜR DİREĞİ	0,33 Kg	6,50TL

Tip testi sertifikası, pano üreticileri için panolarının ilgili standartlara uygun olan elektrikli cihazlar, bara sistemleri, aksesuarlar vb. donatıldığını ve montaj talimatlarına göre kurulmuş yapılar olduğunu garanti eden bir kalite güvence kriteridir.

Type test certificate is a quality assurance system making sure for the panel manufactures that their panel are equipped with the electrical devices, busbar systems, compatible with their elevent standarts and they are srtucture assembler according to the assembly instnuctions.

## MODÜLER TİP ALÇAK GERİLİM DAĞITIM PANOLARI

- » Koruma sınıfı IP41
- » 4000 A'e kadar anma akımı
- » TİP TEST SERTİFİKALI bir pano sisteminin aşağıda listesi verilen testlerden başarıyla geçmesini zorunlu kılar.

## MODULER TYPE LOW VOLTAGE DISTRIBUTION PANELS

- » Protection class IP41
- » Rated current value up to 4000 A
- » The standart in question requires that panel system with TYPE TEST CERTIFICATE should pass the tests listed below successfully

### TEST NO 1

- » 8-2-1: Sıcaklık artış sınırlarının doğrulanması. Sıcaklıklar dengelendiğinde sıcaklık artışı aşağıdaki limitleri aşmamalıdır:
  - 70°C dış iletkenlik klemenslerinde
  - 15°C manuel olarak kontrol edilen cihazlarda veya 25°C, materyal tipine bağlı olarak.
  - 30°C veya 40°C, panonun ulaşılabilir dış yüzeylerde.

«» Firmamız bu testten başarı ile geçmiştir.

### TEST NO 1

- » 8-2-1: Verification of temperature raise limit:
  - When the temperature must not exceed the following values
  - 70°C for the connectors of the external conductors
  - 15°C for devices ckecked manually of 25°C according to the type of the material
  - 15°C or 40°C on the accessible external surface of the panel

«» Our firm passed from this test.

### TEST NO 2

- » 8-2-2: Dielektrik niteliklerin doğrulanması:
  - Test gerilimi bütün enerjili parçalara ve karkasa aynı zamanda her bir faza ve birleştirilmiş diğer faz arasında uygulanır.
  - Test gerili: 2500V.
  - Uygulama süresi: 1 dakika.

«» Firmamız bu testten başarı ile geçmiştir.

### TEST NO 2

- » 8-2-2: Verification of dielectric properties:
  - The test voltage is applied to all the energized components and framework simultaneously to each phase and the internal of the other combined phase.
  - Test voltage 2500V.
  - Application period: 1 minute.

«» Our firm passed from this test.

### TEST NO 3

- » 8-2-3: Kısa devre dayanımının doğrulanması:
  - Kısa devre testi ana veya tali dağıtım baralarının sonuna vidalanmış bağlantılar yardımı ile yapılır.
  - Standart, testin üretici tarafından belirlenen kısa devre akımına göre gerçekleşmesini tanımlar.
  - ConCept Serisi için bu değer;  
-65 kA / 1sec. Con-Cept Serisi için elektrik devre ekipmanlarının mekanik dayanımlarının kısa boyunca test edilmesi için yapılır.

«» Firmamız bu testten başarı ile geçmiştir.

### TEST NO 3

- » 8-2-3: Verification of the short-circuit withstand strength-  
short-circuit test is performed by the help of the connections  
screwed at the ends of the main or secondary distribution  
busbars.
  - The standart defines the short-circuit voltage specitied by the manufacturer fort the test.
  - For Con-Cept new tech series this value 65 kA / 1 sec.
  - Electro-dynamic resistance of the electrical circuit equipment thoohtoot the short circuit period.

«» Our firm passed from this test.

## TEST NO 4

- » 8-2-4: Koruyucu devre sürekliliğinin doğrulanması:  
Bu test iki test ile belirlenir.
- Ünitelerin açıktaki iletken bölümleri ile koruma devresi arasındaki etkin bağlantının doğrulanması.
  - Koruma devresi kısa dayanımının doğrulanması.

«» Firmamız bu testten başarı ile geçmiştir.

## TEST NO 5

- » 8-2-5: Yalıtma aralıkları ve yüzeyel kaçak yolu uzunluklarının doğrulanması:
- Standartlarda verilen değerler çıplak enerjili iletkene ve panoya uygulanır. Havadaki minimum yalıtım aralığı darbe dayanma gerilimine ve pano içindeki kirliliğe bağlıdır.
  - Yüzeyel kaçak yolu uzunluğu yalıtım gerilimine, kirliliğin derecesine, yüzeyleri ayıran izolasyon materyalinin tipine bağlıdır.

«» Firmamız bu testten başarı ile geçmiştir.

## TEST NO 6

- » 8-2-6: Mekanik çalışmanın doğrulanması, mekanik testi iç montajı yapılmış panoya uygulanır. Standartların gerektirdiği gibi test 50 defa gerçekleştirilir.

«» Firmamız bu testten başarı ile geçmiştir.

## TEST NO 7

- » 8-2-7: Koruma derecesinin doğrulanması: bu test aşağıdaki noktalar doğrultusunda panonun kabiliyetini belirlemek amacıyla yapılır.
- İnsanların enerjili kısımlara dokunmalarına karşı korunması.
  - Ekipmanların içine katı parçaların veya sıvıların nüfuz etmesini önlemek.
  - Ekipmanı dış etkilere karşı korumak.

«» Firmamız bu testten başarı ile geçmiştir.

## TEST NO 4

- » 8-2-4: Verification of the continuity of the protective circuit:  
This test is defined by two tests.
- Verification of conductors units oened section with protective circuit effective connection.
  - Veritication of protective circuit and short circuit withstand streght.

«» Our firm passed from this test.

## TEST NO 5

- » 8-2-5: Verification of the clearance creepage distances:
- The values spesified in the standart are applied to the standart are applied to the bare conductor and panel. The minimum isolation internal in air depends on the stockresisling voltage and the impurities will the panel.
  - The lenght of the surface power leakage route will depend on the isolation material that seperates the cnductive surfaces.

«» Our firm passed from this test.

## TEST NO 6

- » 8-2-6: Verification of the mechanical operation, mechanical test is applied to the panel with inner assembly each test may be performed 50 times as required under the applicanle standart.

«» Our firm passed from this test.

## TEST NO 7

- » 8-2-7: Verification of the degrees of protection: This test is performed to determine capability of the panel in relation with the following points.
- Protecting people against touching the energized componants.
  - Preventing any solid particles or liquids from leaking in to the products.
  - Protecting the equipment again external effects.

«» Our firm passed from this test.



Form 4 Uygulaması



Form 4 Uygulaması



Ana Trafo Uygulaması



Gemi Kontrol Panoları



Sinyalizasyon Panosu



Dikili Sistem MMC Pano Uygulaması



Stüdyo Aydınlatma Pano Uygulaması



## ÜÇ FAZLI MOTORLARDA ANMA AKIMINA GÖRE SİGORTA SEÇİMİ

### FUSE SELECTION FOR THREE PHASE MOTORS ACCORDING TO RATED CURRENT

Motor Gücü Motor Powers		CosØ	220V Motor Anma Akımı 220V Motor Rated Current	Sigortalar Fuses		380V Motor Anma Akımı 380V Motor Rated Current	Sigortalar Fuses		Bağlantı Kablosu NYN-NYCY mm <sup>2</sup> Connection Cable NYN-NYCY mm <sup>2</sup>
kW	PS			Direk Directly	Y/Δ		Direk Directly	Y/Δ	
0.25	0.34	0.70	1.4	4	2	0.8	2	2	4x2.5
0.37	0.50	0.72	2.1	4	2	1.6	4	2	4x2.5
0.55	0.75	0.75	2.7	4	4	1.6	4	2	4x2.5
0.75	1	0.80	5.4	6	1	2	4	4	4x2.5
1.1	5	0.80	4.4	6	6	2.6	4	4	4x2.5
1.5	2	0.83	6	16	10	3.5	6	6	4x2.5
2.2	3	0.84	8.7	20	16	5	10	6	4x2.5
3	4	0.84	11.5	20	16	6.6	16	10	4x2.5
4	5.4	0.84	14.7	25	20	8.5	20	16	4x2.5
5.5	7.5	0.85	14.8	35	25	11.5	25	20	4x2.5
7.5	10	0.86	26.5	50	35	15.5	35	25	4x4
11	15	0.86	39	63	50	22.5	35	35	4x6
15	20	0.86	52	50	63	30	50	35	4x6
18.5	25	0.86	62	100	80	36	63	50	4x10
22	30	0.87	74	100	80	43	63	50	4x10
30	40	0.87	98	125	100	57	80	63	4x16
37	50	0.87	124	200	160	72	100	80	3x25+16
45	61	0.88	147	225	200	85	125	100	3x35+16
55	75	0.88	180	250	225	104	60	125	3x50+25
75	100	0.88	246	350	250	142	200	60	3x75+35
90	123	0.88	-	-	-	169	225	200	3x95+50
110	150	0.88	-	-	-	204	250	225	3x120+70
132	180	0.88	-	-	-	243	300	250	3x120+70

## KULLANILAN KABLO BOYUTLARINA GÖRE RAKOR TİPLERİ

### PG CABLE GLAND SIZE

Rakor Tipi PG Size	Rakordan Geçirilen Bazı Kablo Cinsleri Some Used Cable Types		Rakordan Geçirilen Bazı Kablo Cinsleri Some Used Cable Types		Min-Max. Kablo Çapı For Cable Q Min.- Max. (mm)	Rakor Çapı Hole Diameter To Be Punched Q (mm)
PG-7					3-65	12.5
PG-9	1x1.5				4-8	15.5
PG-11	1x6				5-10	18.5
PG-13.5	1x16	2x1.5	3x15		6-12	20.5
PG-16	1x25	2x4	3x25	4x15	10-14	22.5
PG-21	1x70	2x10	3x10	4x6	13-18	28.5
PG-29	1x150	2x25	3x16	4x16	18-20	37.5
PG-36	1x300	2x50	3x35	4x35	22-32	47
PG-42	3x50+25		3x70	4x50	32-38	55
PG-48	3x70+35		3x95	4x70	37-44	60

## IP KORUMA SINIFLARI

### DEFINITION OF IP PROTECTION DEGREES

Birinci Rakam First Number	Katı Cisimlere Karşı Koruma Protection Against Solid Objects	İkinci Rakam Second Number	Sıvı Maddelere Karşı Koruma Protection Against Liquids Objects
0	Koruma Yok No Protection	0	Koruma Yok No Protection
1	50mm'den büyük katı cisimlere karşı koruma Protected against solid object; diameler $\geq$ 50mm	1	Dik süşen su damlalarına karşı koruma Protected against vertical dripping water
2	12mm'den büyük katı cisimlere karşı koruma Protected against solid object; diameler $\geq$ 12mm	2	15'lik açığa kadar eğik damlayan suya karşı koruma Protected against 15° langle from the vertical  dripping water
3	2.5mm'den büyük katı cisimlere karşı koruma Protected against solid object; diameler $\geq$ 2.5mm	3	60'lik açığa kadar eğik damlayan suya karşı koruma Protected against 60° langle from the vertical  sprays water
4	1mm'den büyük katı cisimlere karşı koruma Protected against solid object; diameler $\geq$ 1mm	4	Her yönden gelen su damlalarına karşı koruma Protected against every direction of sprays water
5	Toza karşı koruma Protected against dust (hamless amount permitted)	5	Su püskürtmelerine karşı koruma/ Protected against low pressure water join from all directions (hamless amount permitted)
6	Toza karşı tam koruma Completely protected against dust	6	Şiddetli deniz dalgalarına karşı koruma/ Protected against strong water just from all directions (hamless amount permitted)
		7	Suya batırmalara karşı koruma/ Temporary protected against immersion in (water must not penetrate in harmful quantity ad descibad period)
		8	Basınç altında uzun süre suda kalmaya karşı koruma/ Protected against under pressure long prints of immersion in water

## BAKIR BARA AKIM TAŞIMA KAPASİTESİ

Bara/ Bara			Devamlı Yükleme Akımı (A) 50 Hz. A.A. / Permissible Loading (A) With 50Hz.							
Boyut mm Width Thines	Kesin mm Cross Section	Ağırlık kg/m. Weight	Boyalı Bara Adedi / Number Of Bars (Painted)				Çıplak Bara Adedi / Number Of Bars (Bare)			
			I	II	III	IV	I	II	III	IV
12x2	24	0.21	125	250			110	220		
15x2	30	0.27	155	270			140	240		
15x3	45	0.40	185	330			170	300		
20x2	40	0.36	205	350			185	315		
20x3	60	0.54	245	425			220	380		
20x5	100	0.89	325	550			290	495		
25x3	75	0.67	300	510			270	460		
25x5	125	1.12	385	670			350	600		
30x3	90	0.80	350	600			315	540		
30x5	150	1.34	450	780			400	700		
40x3	120	1.07	460	780			420	710		
40x5	200	1.78	600	1000			520	900		
40x10	400	3.56	835	1500	2060	2800	750	1350	1850	2500
50x5	250	2.23	720	1200	1750	2300	630	1100	1500	2100
50x10	500	4.45	1025	1800	2450	3330	920	1620	2000	3000
60x5	300	2.67	825	1400	1980	2650	750	1300	2800	2400
60x10	600	5.34	1200	2100	2800	3800	1100	1860	2500	3100
80x5	400	3.56	1060	1800	2450	3300	950	1650	2200	2900
80x10	800	7.12	1540	2600	3300	4600	1400	2300	3100	4200
100x5	500	4.45	1310	2200	2950	3800	1100	2000	2600	3400
100x10	1000	8.90	1880	3100	4000	5400	1700	2700	3600	4800
120x10	1200	1.68	2200	3500	4600	6100	2000	3200	4200	5500
160x10	1600	14.24	2880	4400	7800	7800	2600	3900	5200	7000





**YAVUZ PANO**

Elektrik Panolarında Güvenilir Kaynak  
Reliable Supply in Electrical Enclosures

**Y-SYSTEM**

Modüler Pano Sistemleri

**NET-RACK**

19 " Rack Kabin Sistemleri

**POLİ**  
Polikarbon Pano

**Xplastica**

Plastik Kablo Taşıma Sistemleri

**VIZLight**

Aydınlatma Sistemleri

Yetkili Satıcımız

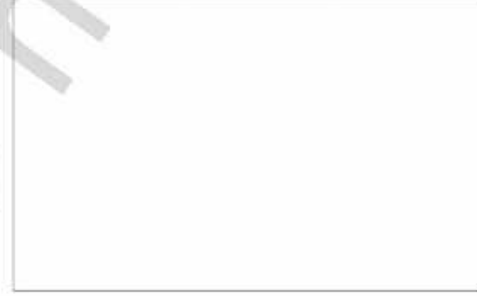

Yavuz Pano Elektrik İnşaat San.ve Tic.A.Ş.

**MERKEZ:** İmes Karşısı, Şerifali Çiftliği Türker Cd. Burhan Sk. No:36 Y.Dudullu Ümraniye - İSTANBUL / TURKEY

Tel: +90 216 499 81 06 (3 Hat) 420 50 88 Fax: +90 216 365 96 23

**ŞUBE:** Bankalar Cad. Porsuk Sk. Köşe Han No:2/1 Karaköy - İSTANBUL / TURKEY

Tel: +90 212 253 10 90 Fax: +90 212 254 39 21

E-mail: yavuzpano@yavuzpano.com.tr Web: www.yavuzpano.com.tr