



AKTIF LIGHTING

2011 collection



In 1997 was founded AKTİF AYDINLATMA is continue to grow up with self designs and wide alternatives of products in sector. Our company provides to our customers special design area of metal production. Production is mostly include on lighting metal based accessory. Besides provides all kinds of decorative metal products in architectural projects. Our company has take parted projects of biggest company of our country. You can see reflection of AKTİF AYDINLATMA in the big trade centre, large stores of choicemarks, hotels, projects of villa and houses.

FİRMA HAKKINDA

1997 yılında kurulan AKTİF AYDINLATMA geniş ürün yelpazesi ve kendi tasarımlarıyla sektörde büyümeye devam ediyor.

Firma metal işçiliği üzerine özel imalat alanında hizmet vermektedir. Ayrıca mimari projelerde, tüm özel imalat gerektiren dekoratif metal ürünleride yapmaktadır. Firma ülkemizin en büyük markalarının projelerinde yer almıştır.

Büyük alışveriş merkezleri, seçkin markaların mağazaları, butik oteller, tatil köyleri oteller villa ve konut projelerinde AKTİF AYDINLATMANIN yansımaları görülmektedir.

Ürünlerimiz CE standartlarına uygundur.



Kod/ Code : T-300
☞☞☞ --- 4x20 w



Kod/ Code : T-301
☞☞☞ --- 4x20 w

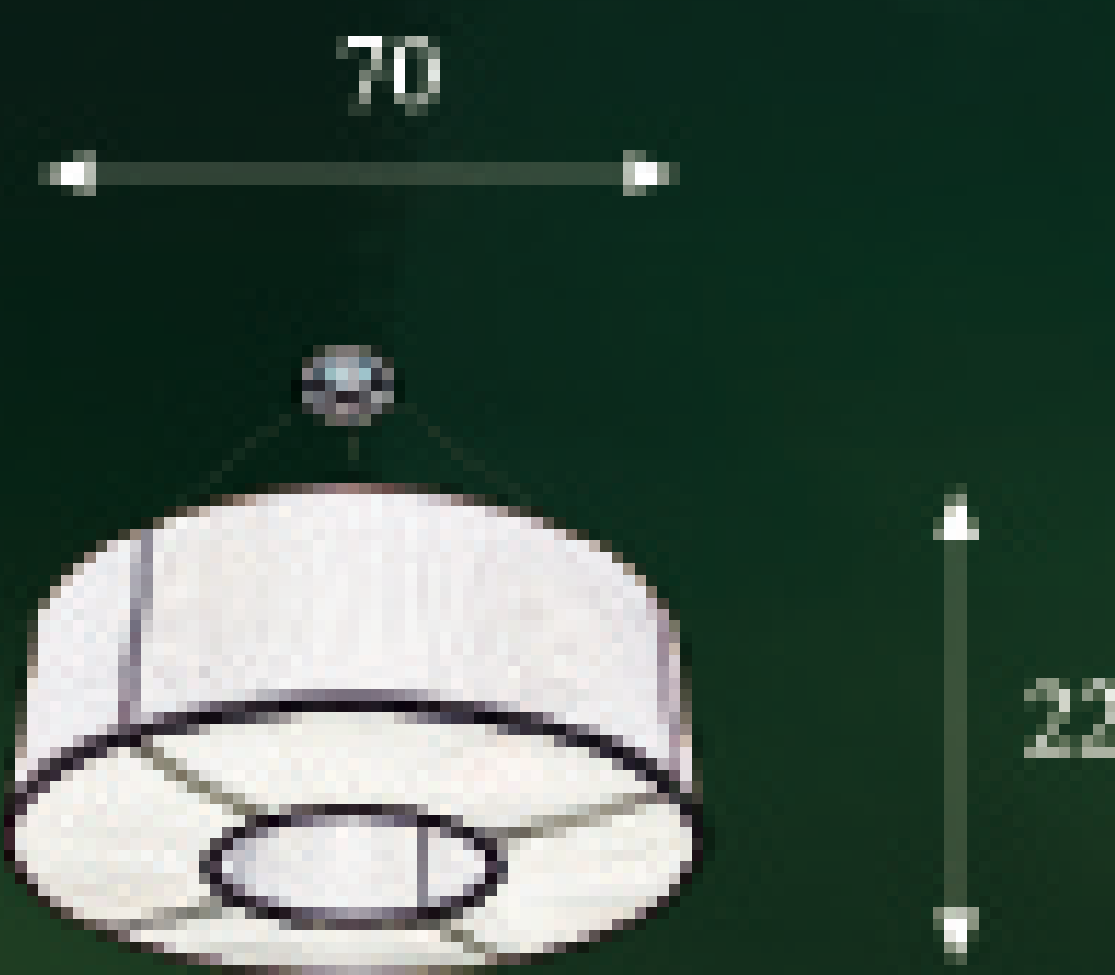

Kod/ Code : T-302
☞☞☞ --- 6x20 w

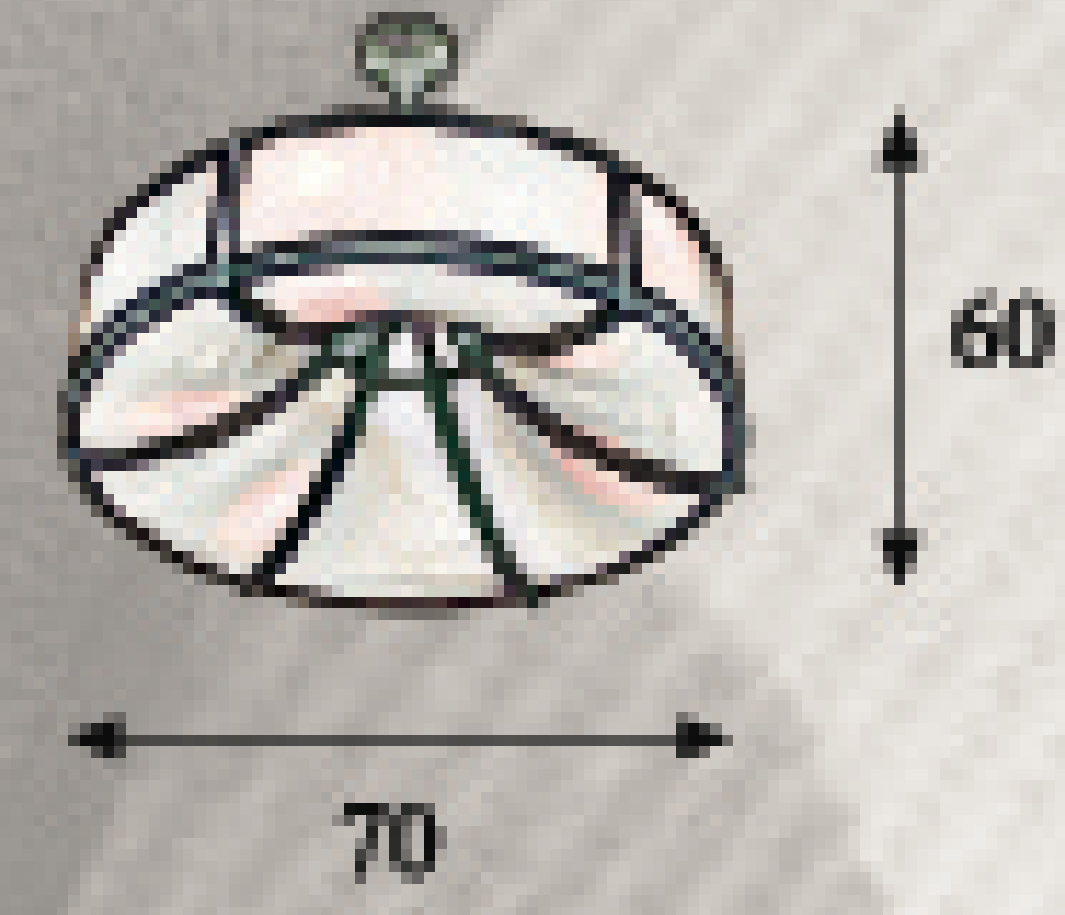
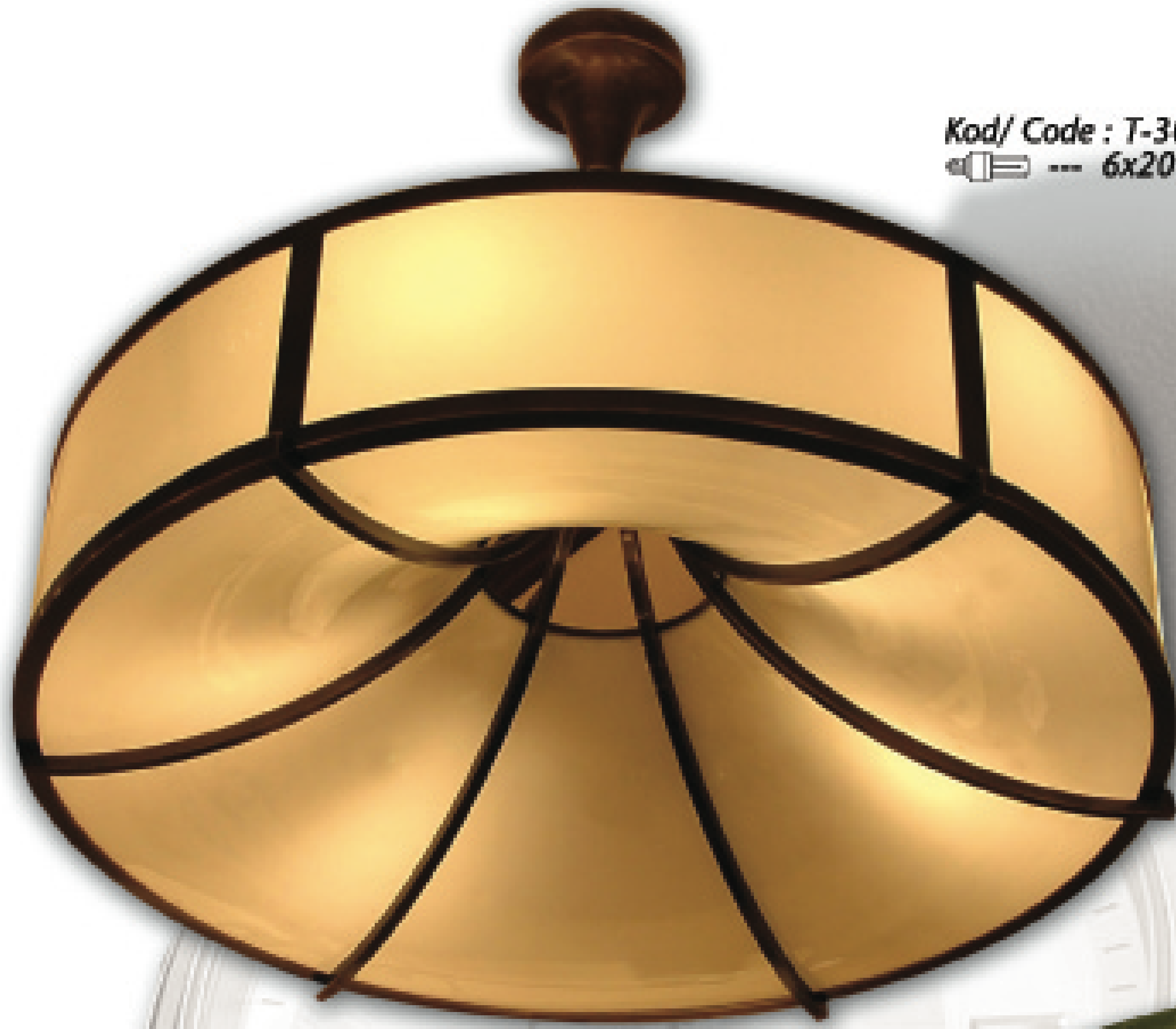

Kod/ Code : T-303
☞☞☞ --- 6x20 w

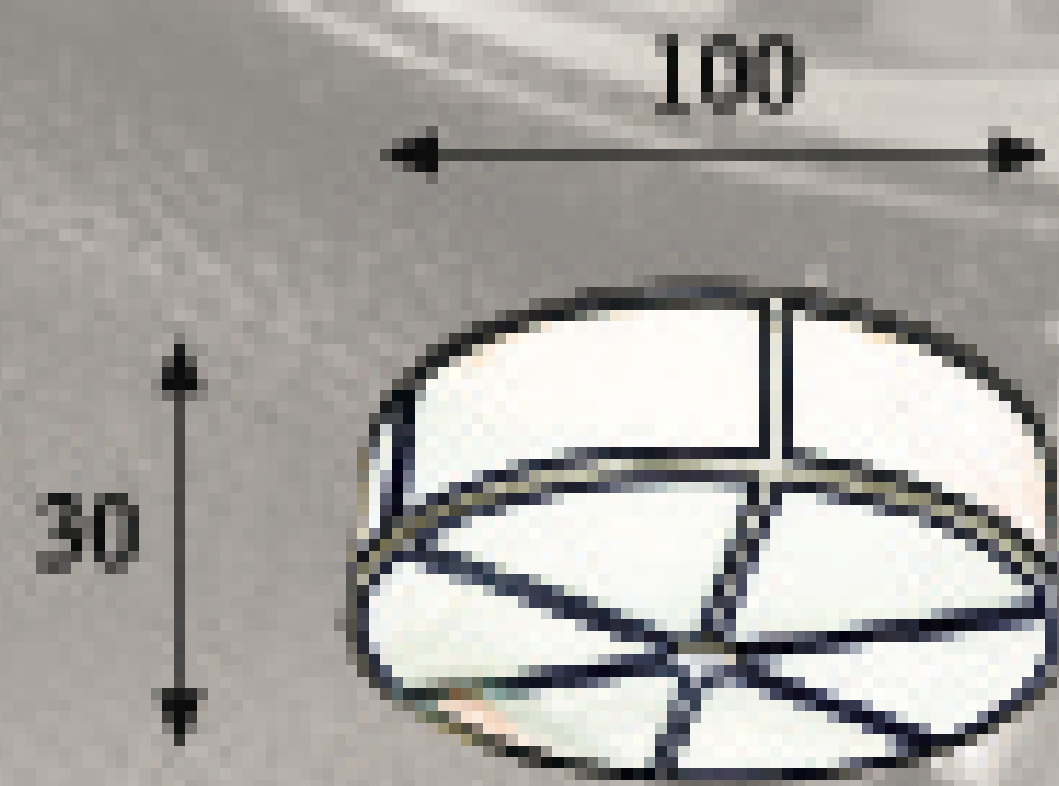
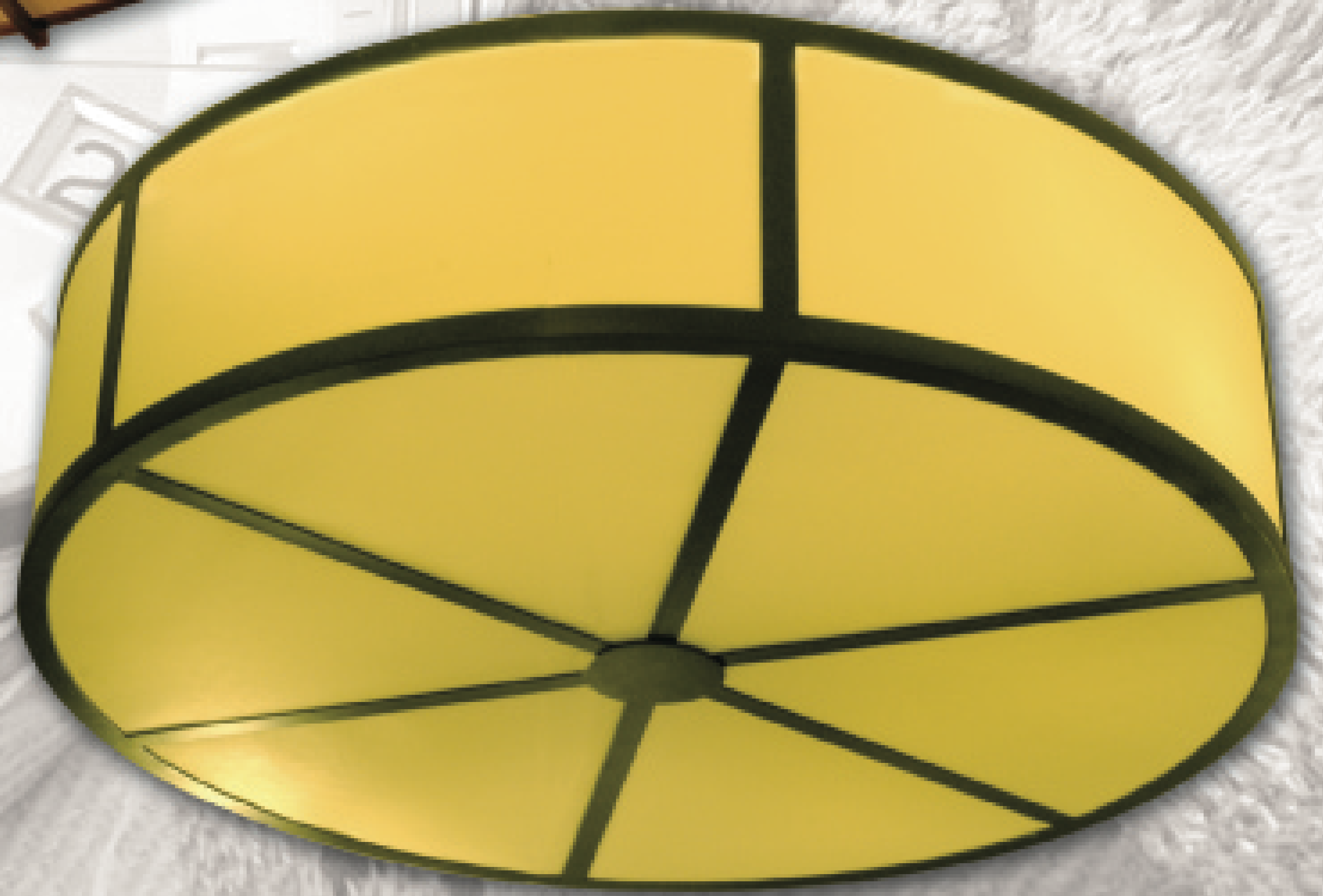

Kod/ Code : T-304
☞☞☞ --- 3x20 w



25



50

23



50

Kod/ Code : T-305
☞☞☞ --- 3x20 w

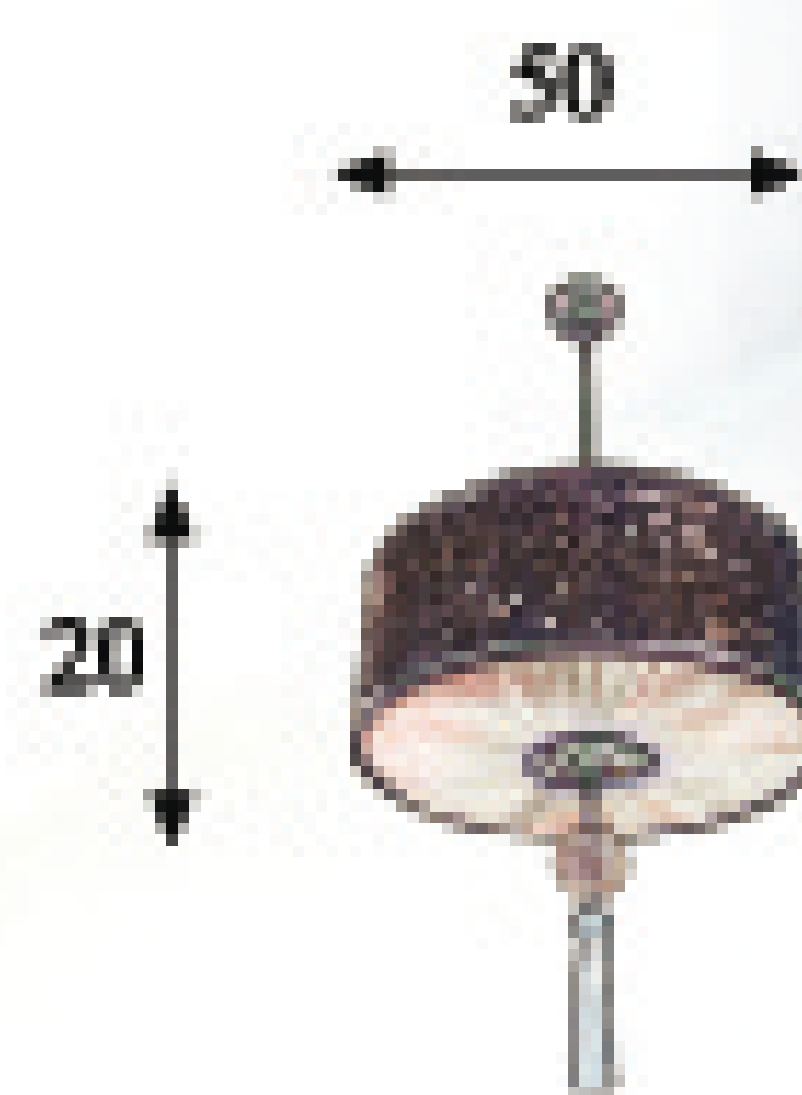

20

50

Kod/ Code : T-306
☞☞☞ --- 3x20 w





Kod/ Code : T-307
☐☐☐ --- 3x20 w



Kod/ Code : T-308
☐☐☐ --- 3x20 w



Kod/ Code : T-309
☐☐☐ --- 3x20 w





Kod/ Code : T-310
☞☞ --- 2x15 w



Kod/ Code : A-400
☞☞ --- 1x20 w



Kod/ Code : L-100
☞☞ --- 2x20 w





Kod/ Code : T-311
☞ --- 3x15 w



Kod/ Code : T-312
☞ --- 3x15 w

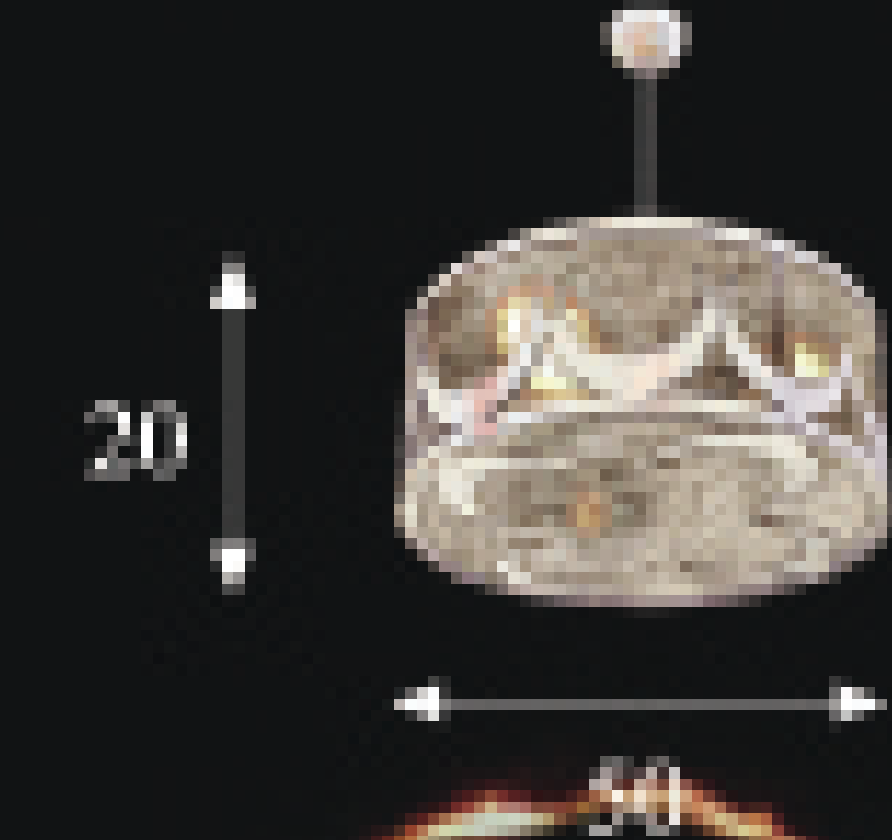
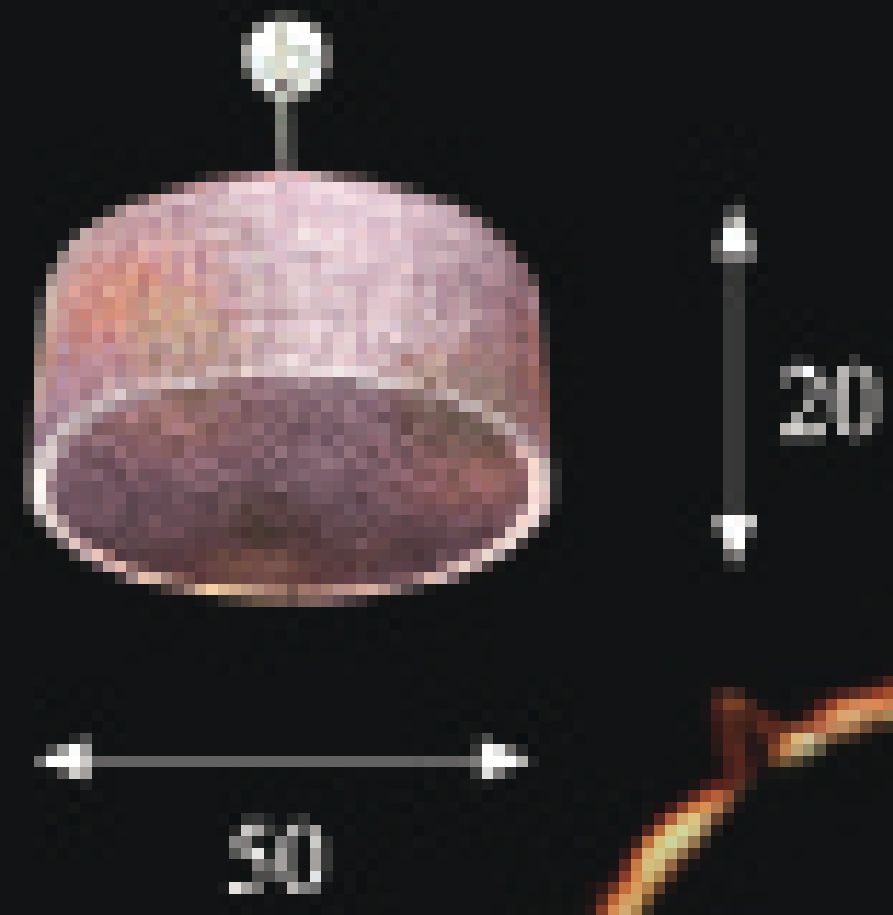

Kod/ Code : T-313
☞ --- 3x15 w

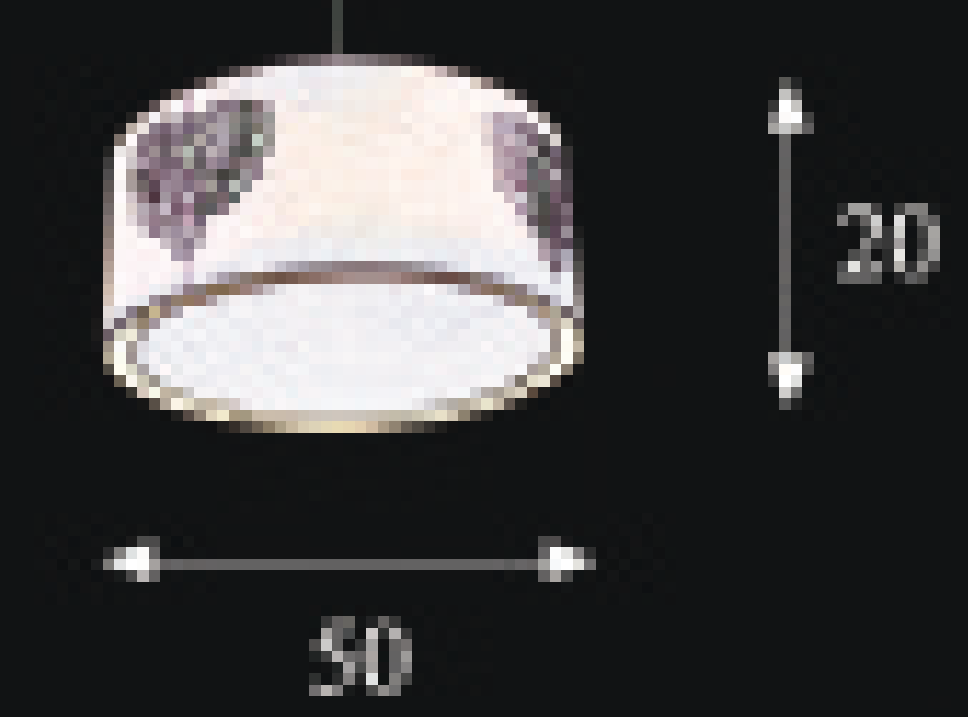



Kod/ Code : T-314
--- 3x20 w



Kod/ Code : T-315
--- 4x20 w

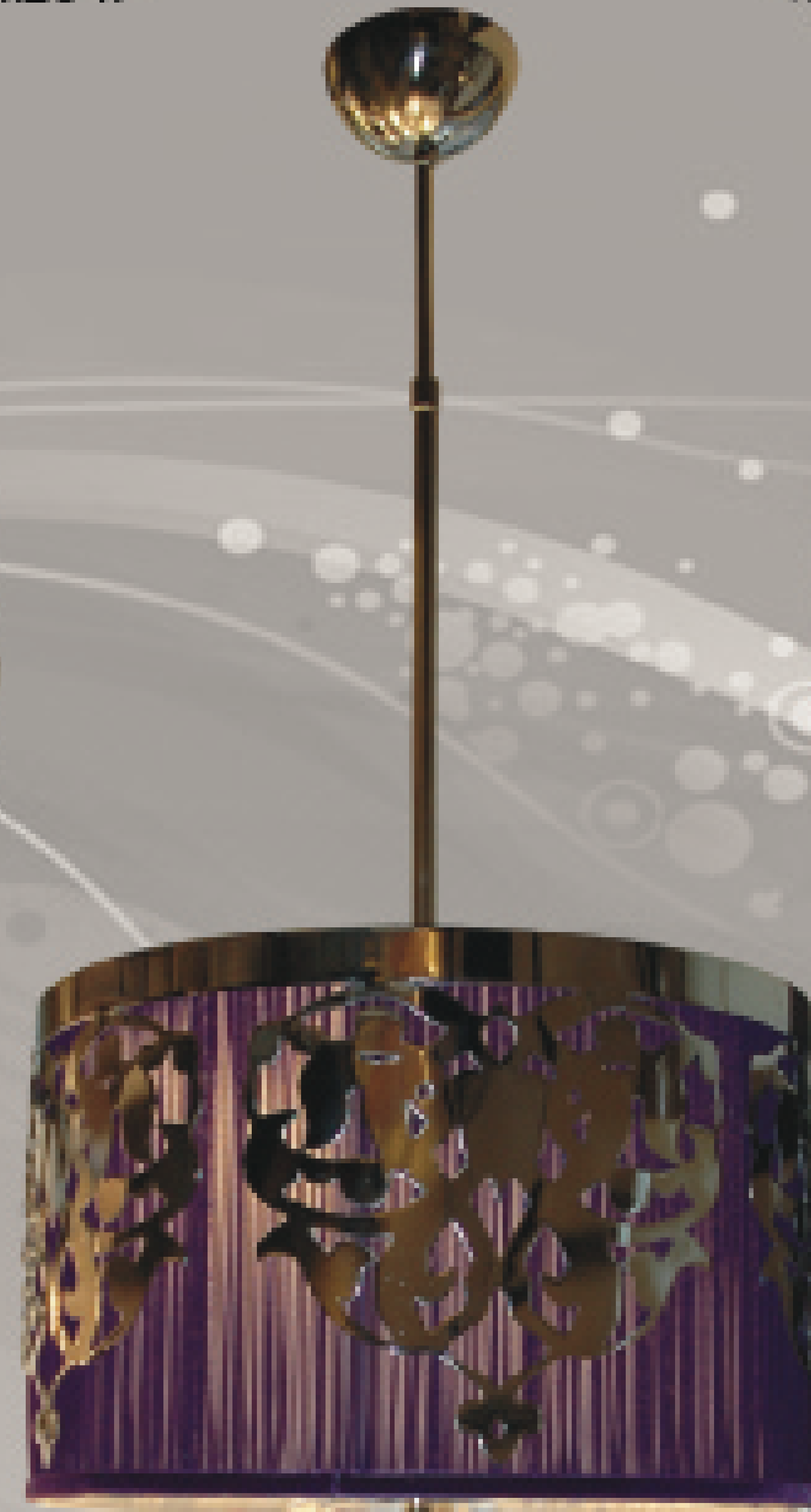

Kod/ Code : T-316
--- 2x20 w





Kod/ Code : T-317
☞☞☞ --- 3x15 w



Kod/ Code : T-318
☞☞☞ --- 3x15 w



Kod/ Code : T-319
☞☞☞ --- 3x20 w

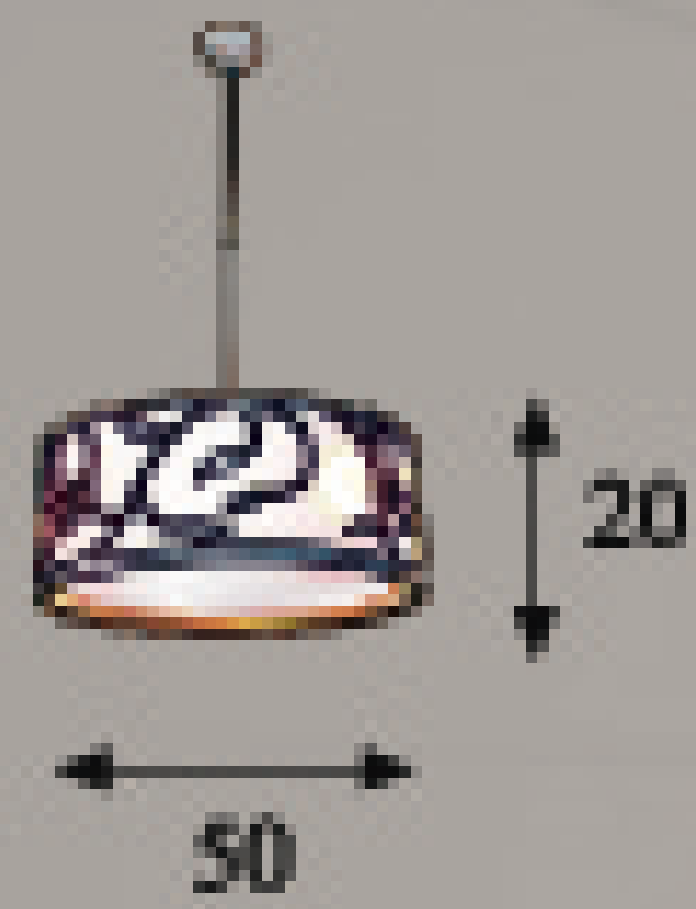



Kod/ Code : T-320
☞☞☞ --- 3x20 w



Kod/ Code : M-200
☞☞ --- 1x20 w



Kod/ Code : M-201
☞☞ --- 1x20 w

Kod/ Code : M-202
☞☞ --- 1x20 w

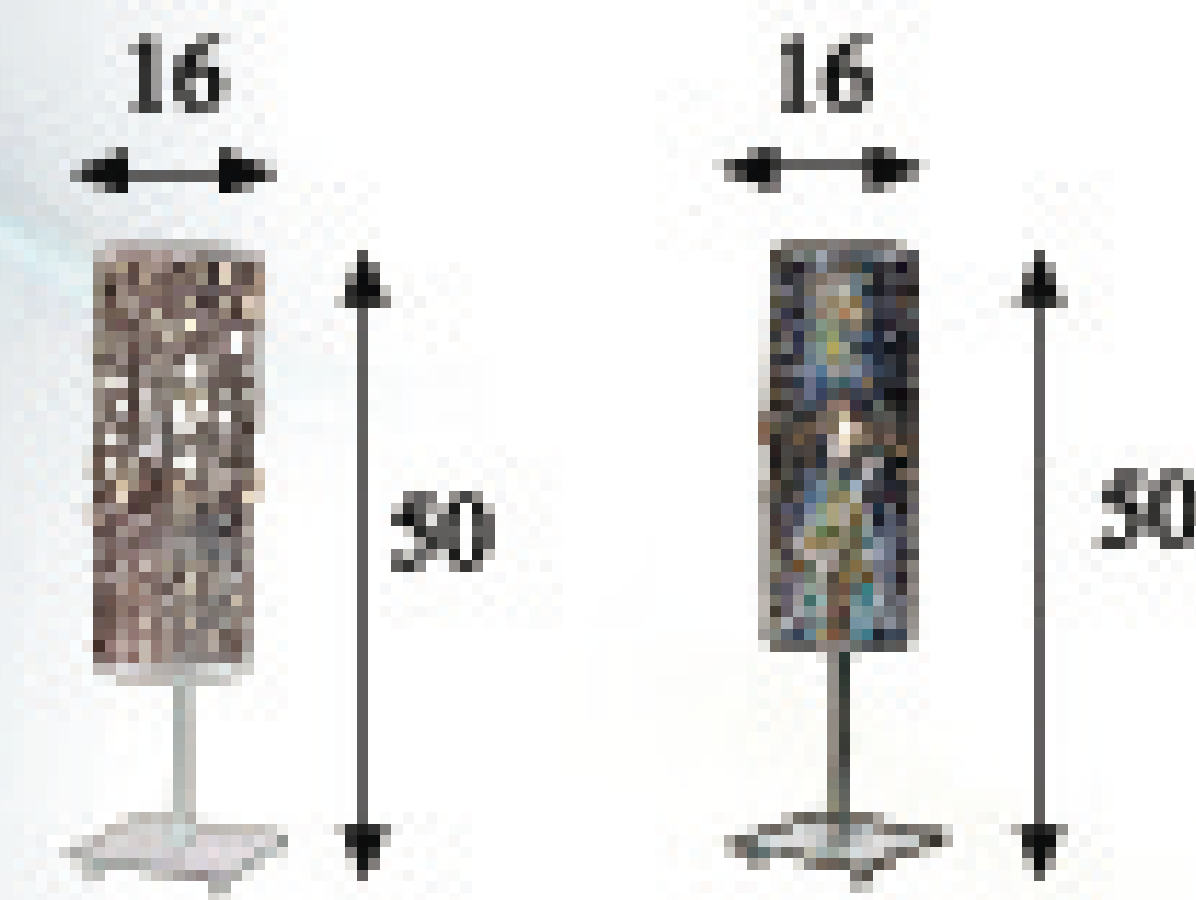



Kod/ Code : T-321
☞☞☞ --- 3x15 w



Kod/ Code : A-401
☞☞ --- 1x15 w



Kod/ Code : T-322
☞☞ --- 1x15 w

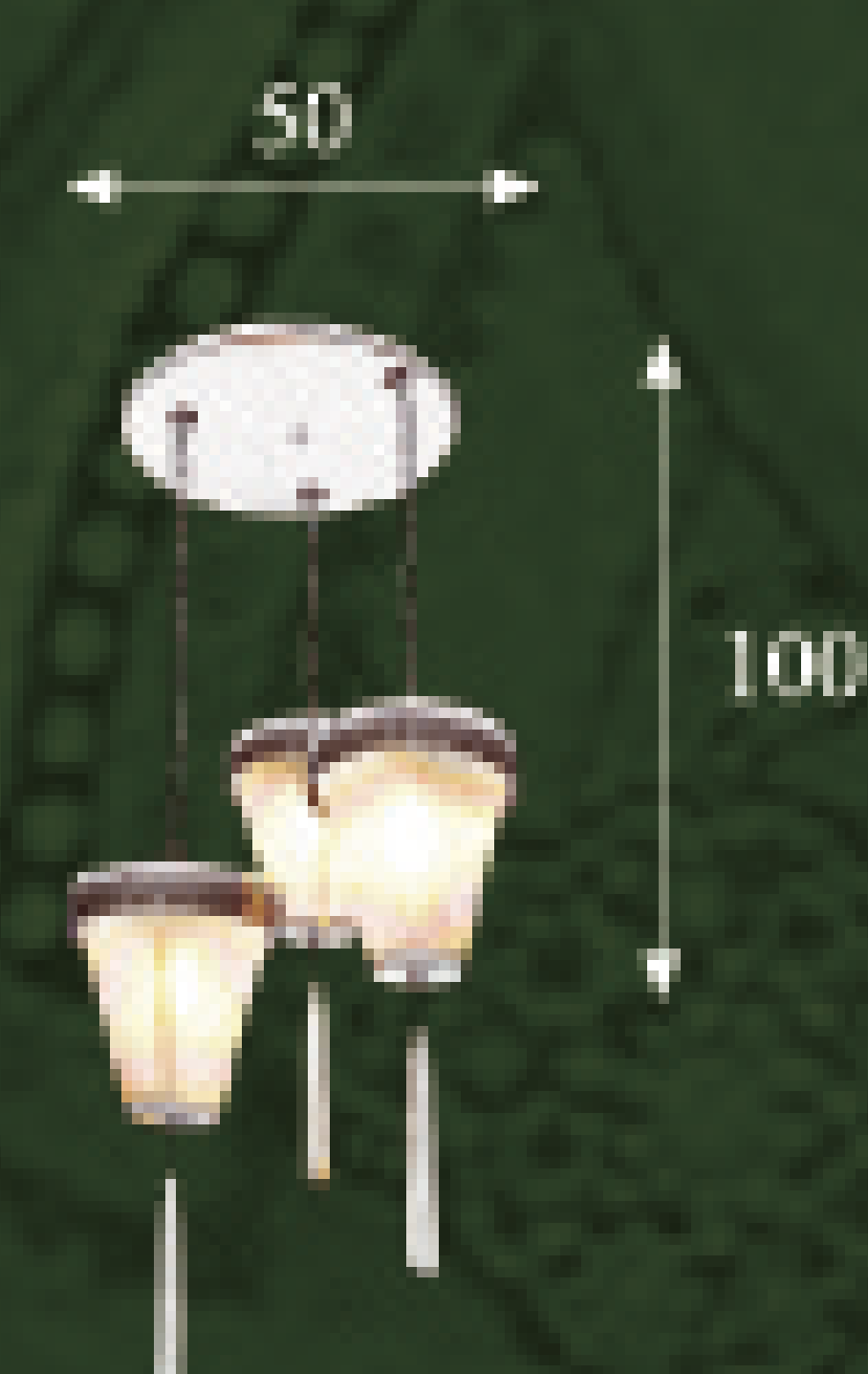

Kod/ Code : T-323
☞☞☞ --- 2x15 w



Kod/ Code : T-324
☞☞☞ --- 3x20 w

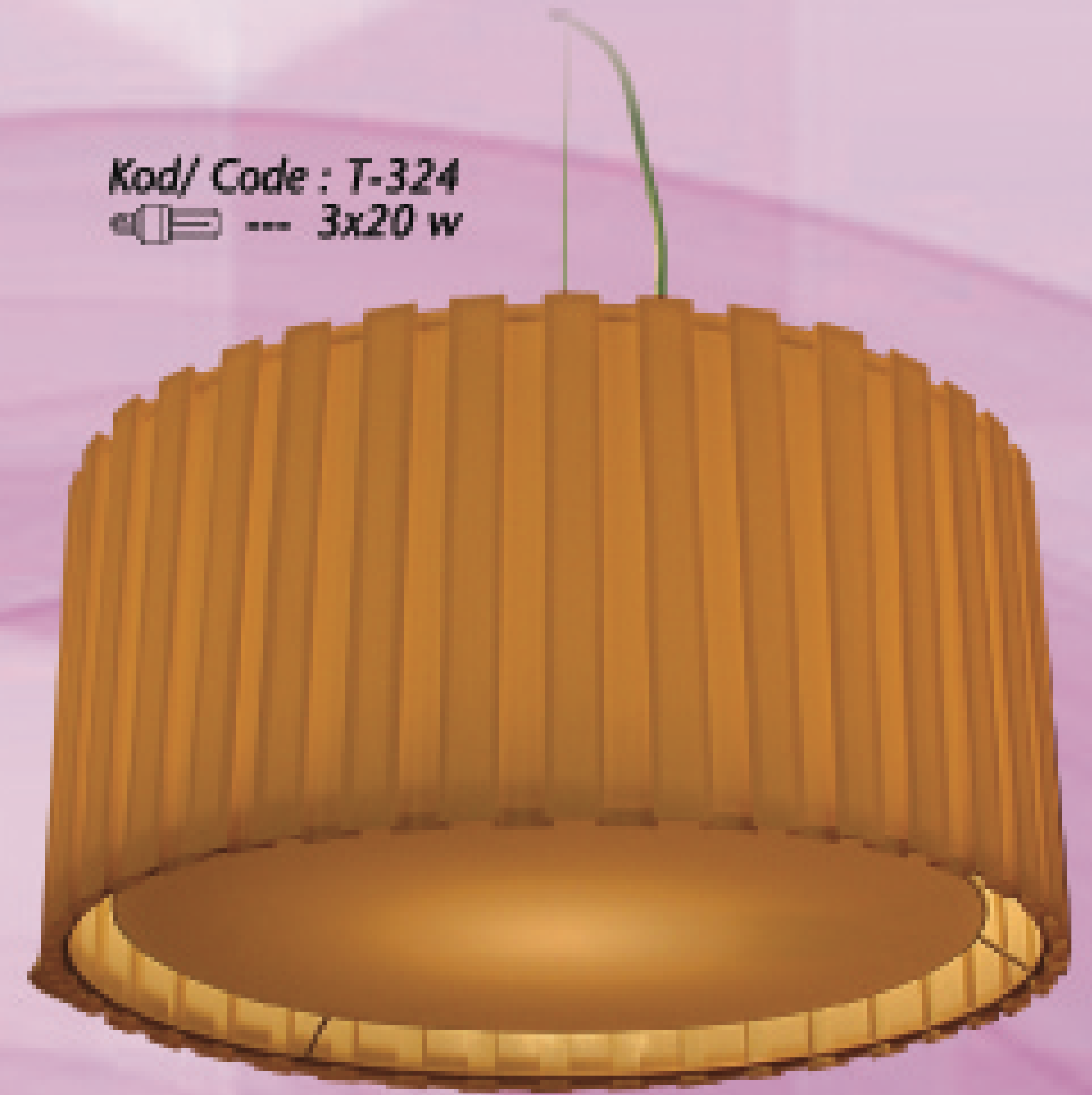

Kod/ Code : T-325
☞☞☞ --- 3x20 w



Kod/ Code : T-326
☛ --- 3x20 w

Kod/ Code : T-327
☛ --- 4x20 w



50



30

60



90

Kod/ Code : T-328
☛ --- 6x11 w

Kod/ Code : T-329
☛ --- 8x11 w



50

80

70

100



Kod/ Code : T-330
☞☞ --- 1x20 w



Kod/ Code : T-331
☞☞ --- 1x20 w

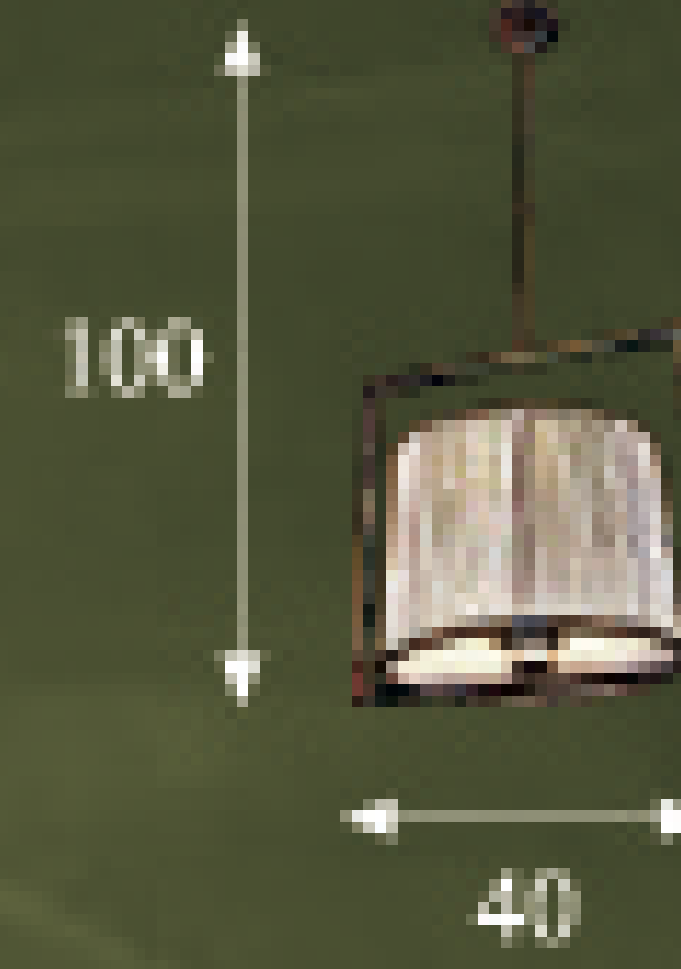

Kod/ Code : T-332
☞☞☞☞ --- 4x15 w

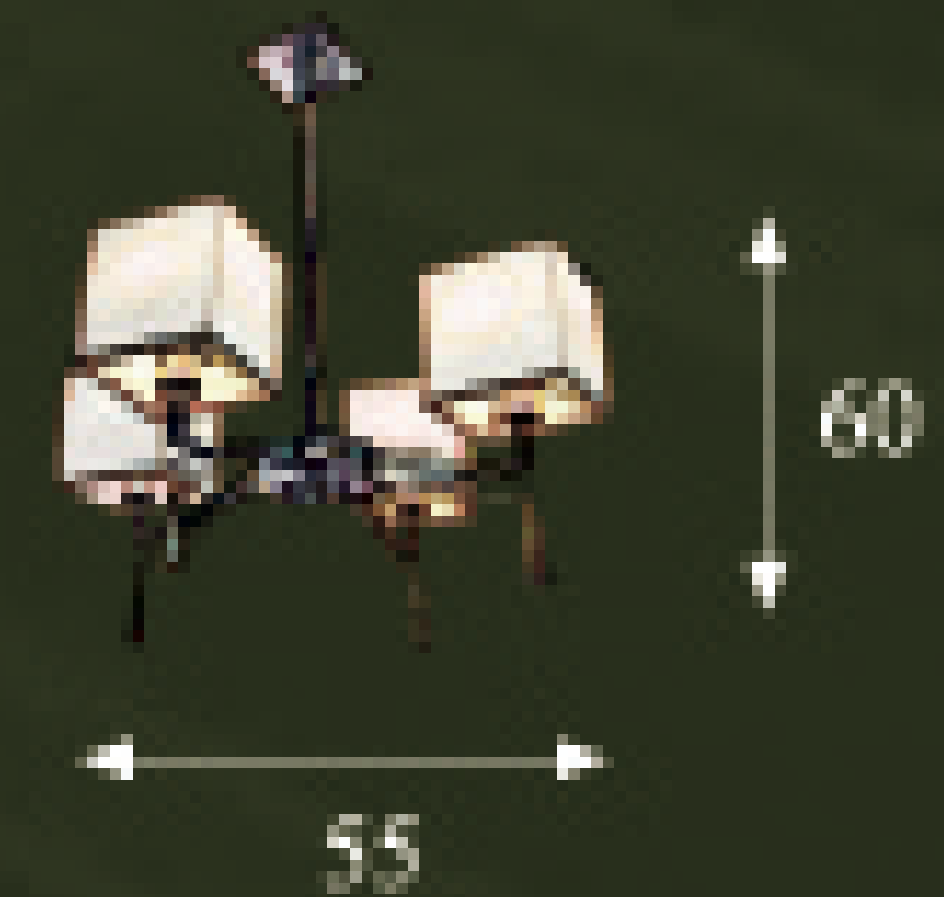

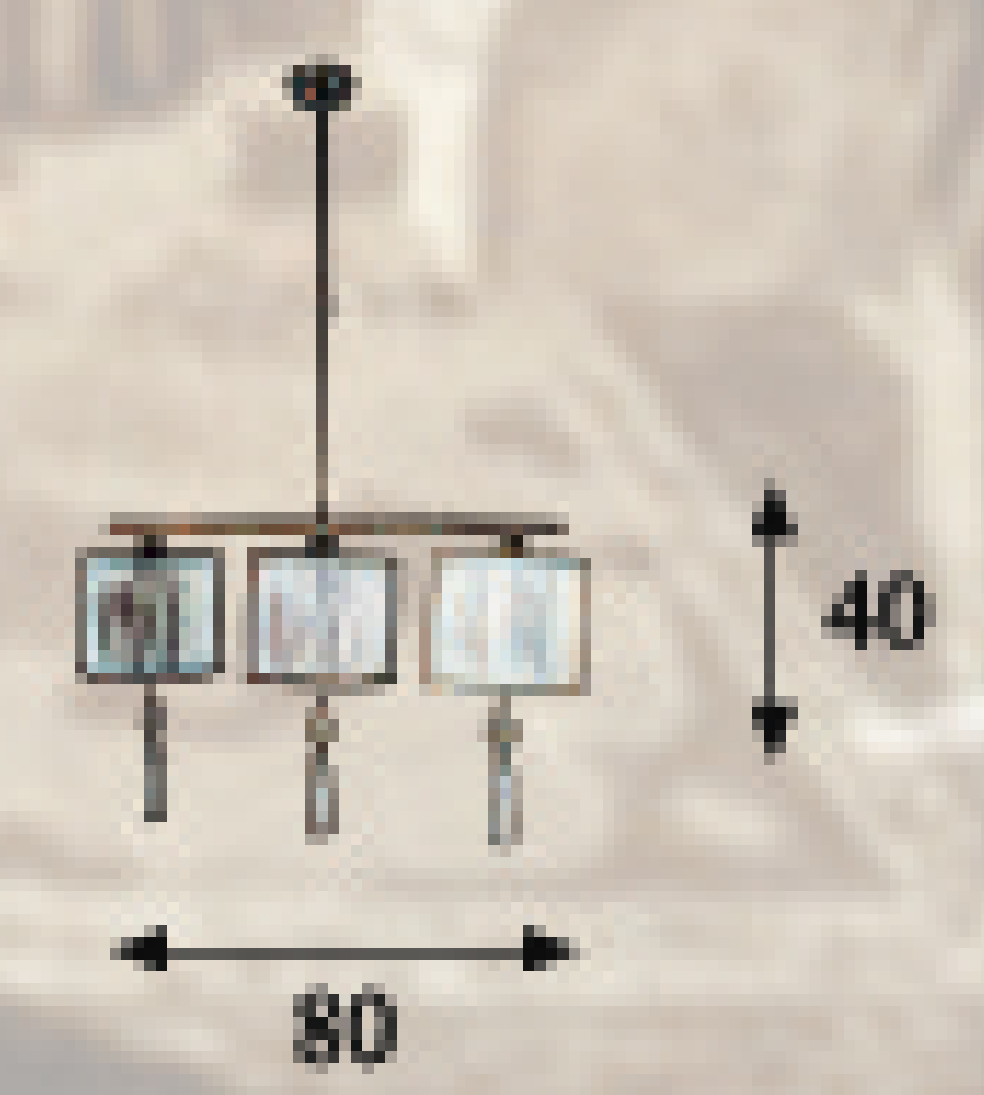

Kod/ Code : T-336
☞ --- 3x15 w



Kod/ Code : T-337
☞ --- 3x15 w



Kod/ Code : T-338
☞ --- 3x15 w

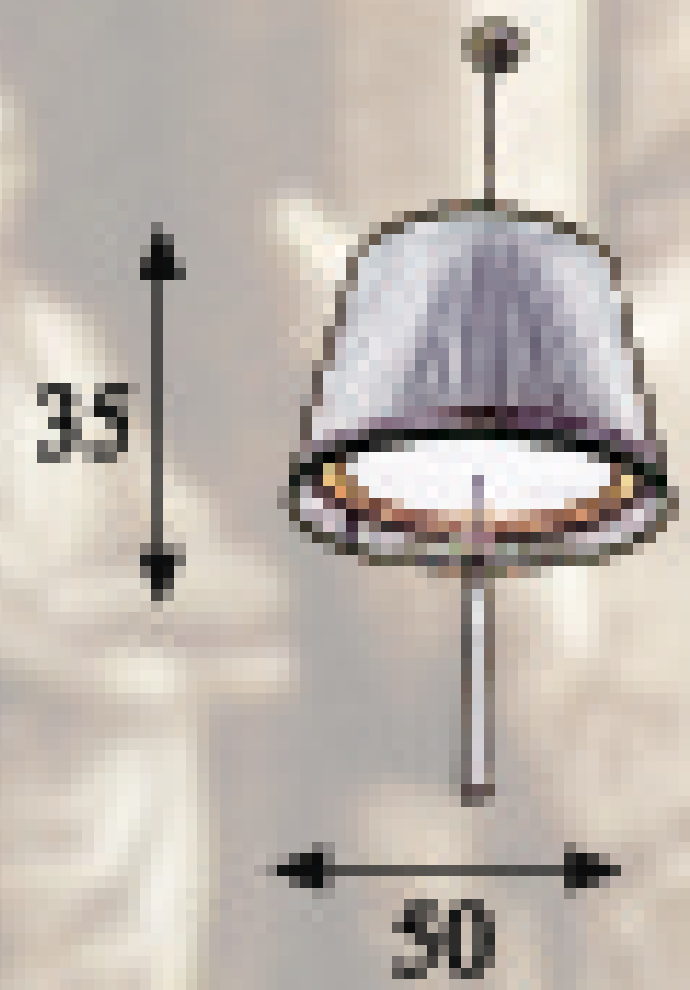



Kod/ Code : T-339
☞☞☞ --- 3x15 w

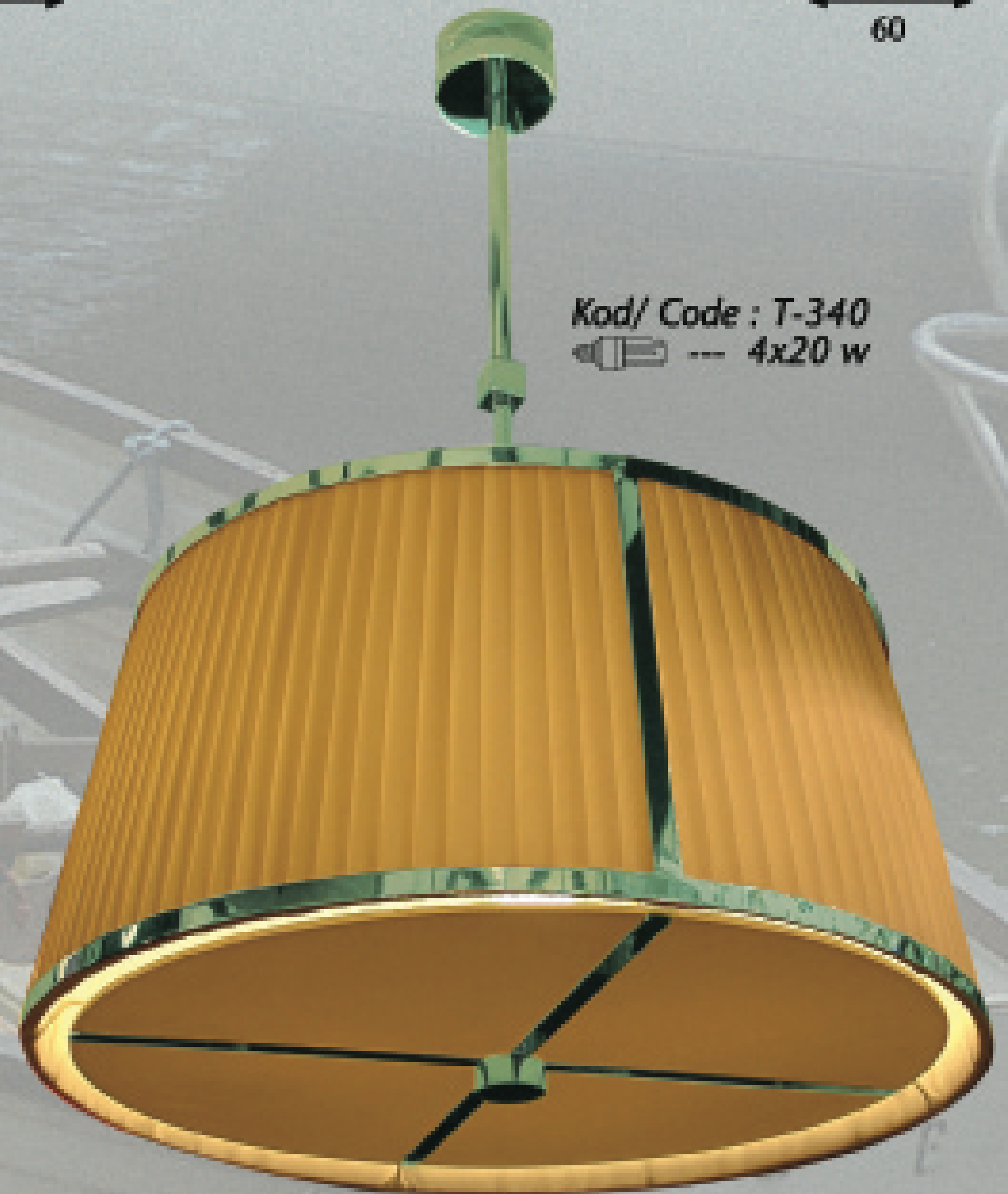
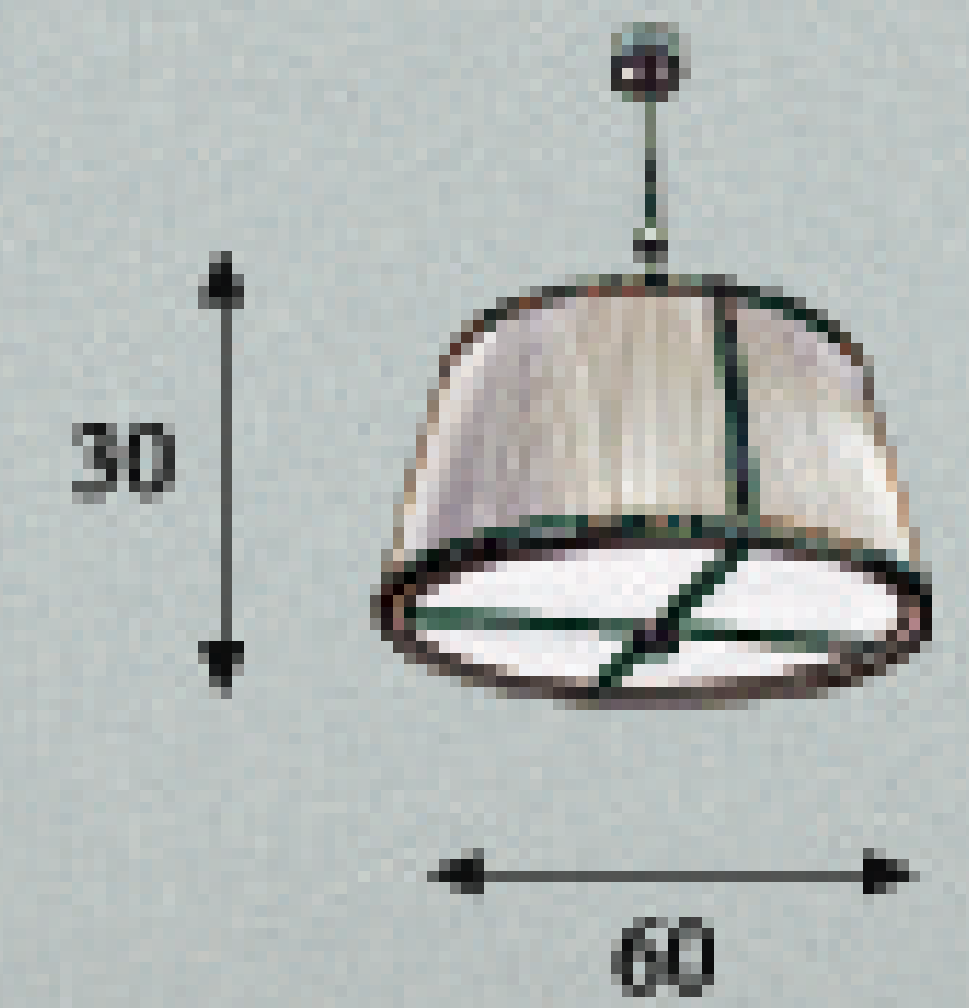
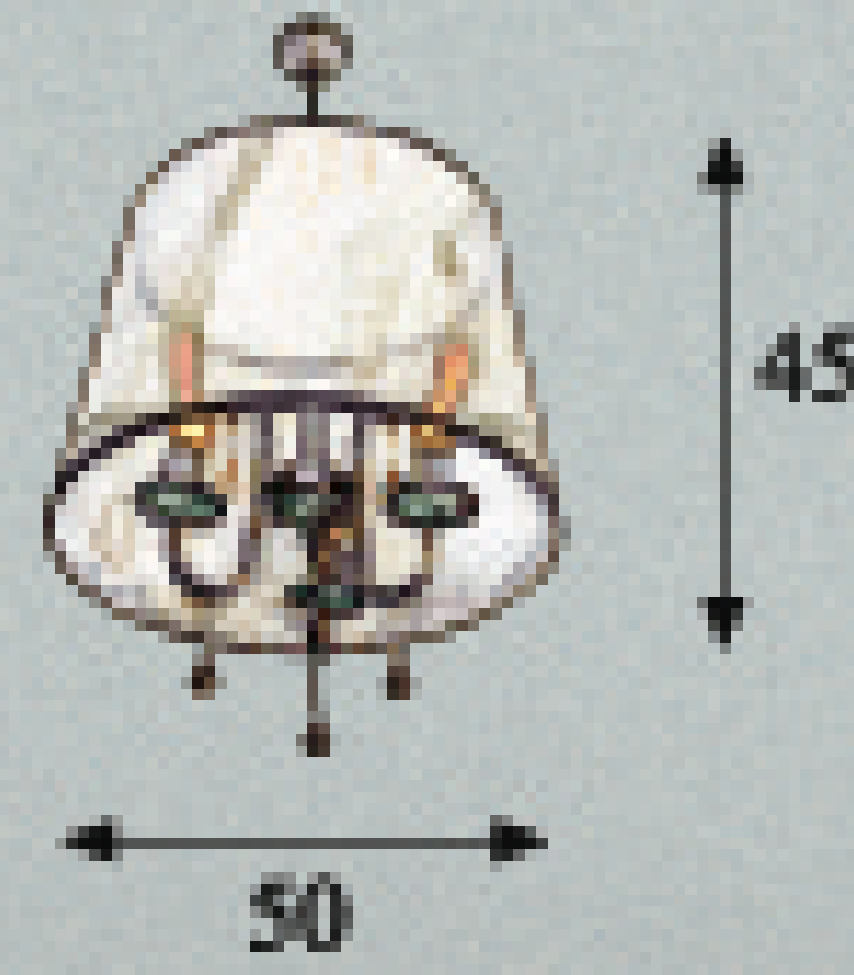

Kod/ Code : T-340
☞☞☞☞ --- 4x20 w

Kod/ Code : T-341
☞☞☞ --- 3x15 w

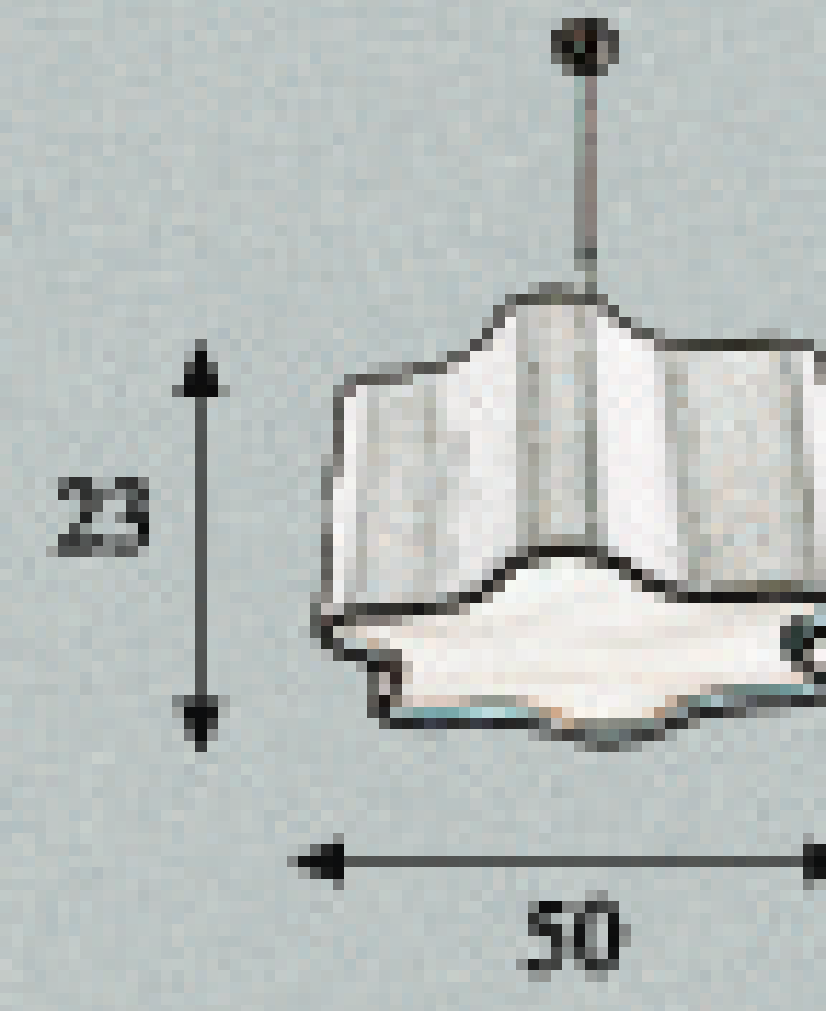

Kod/ Code : T-342
☞☞☞ --- 3x15 w

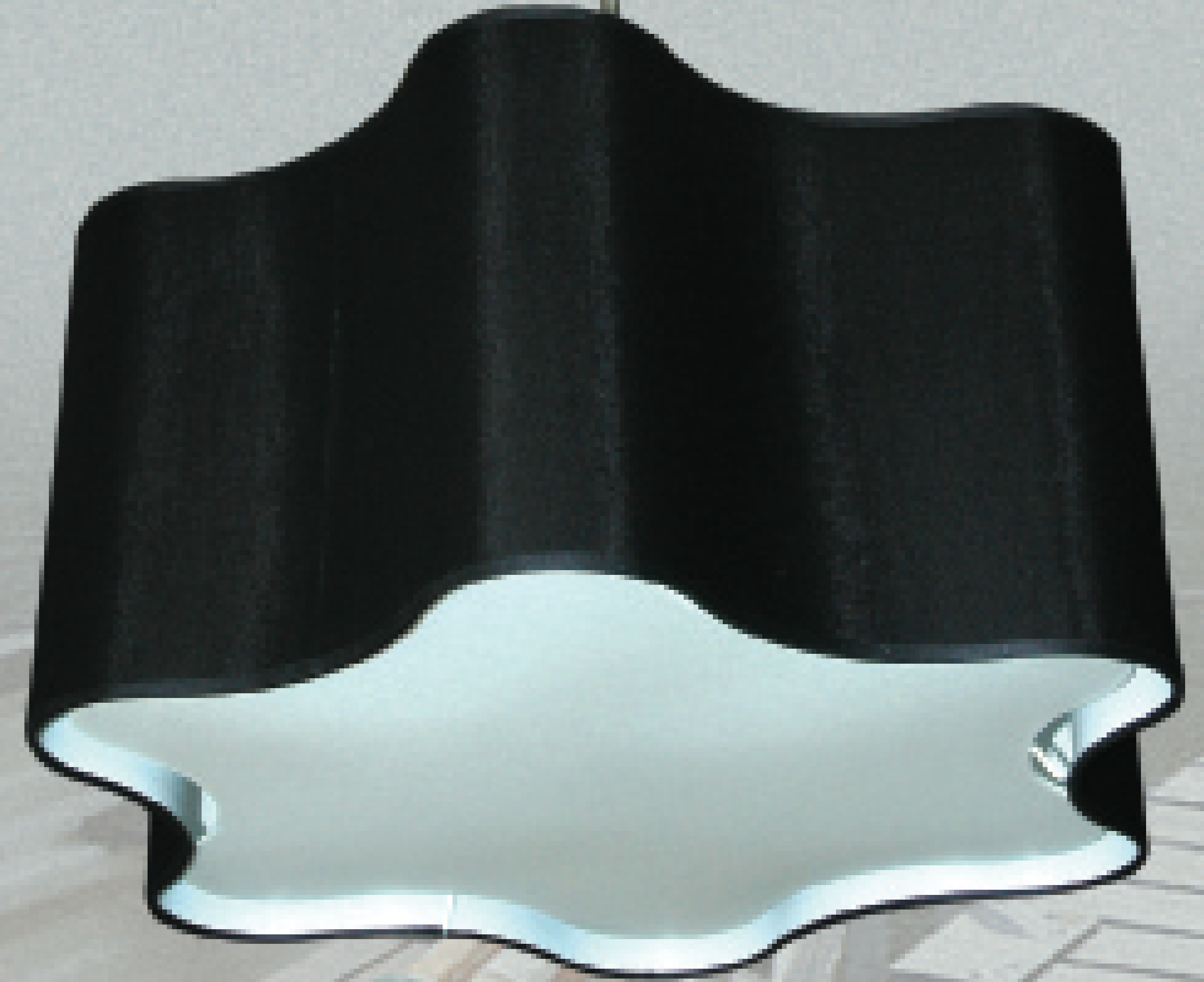

Kod/ Code : T-343
☞☞☞ --- 3x11 w

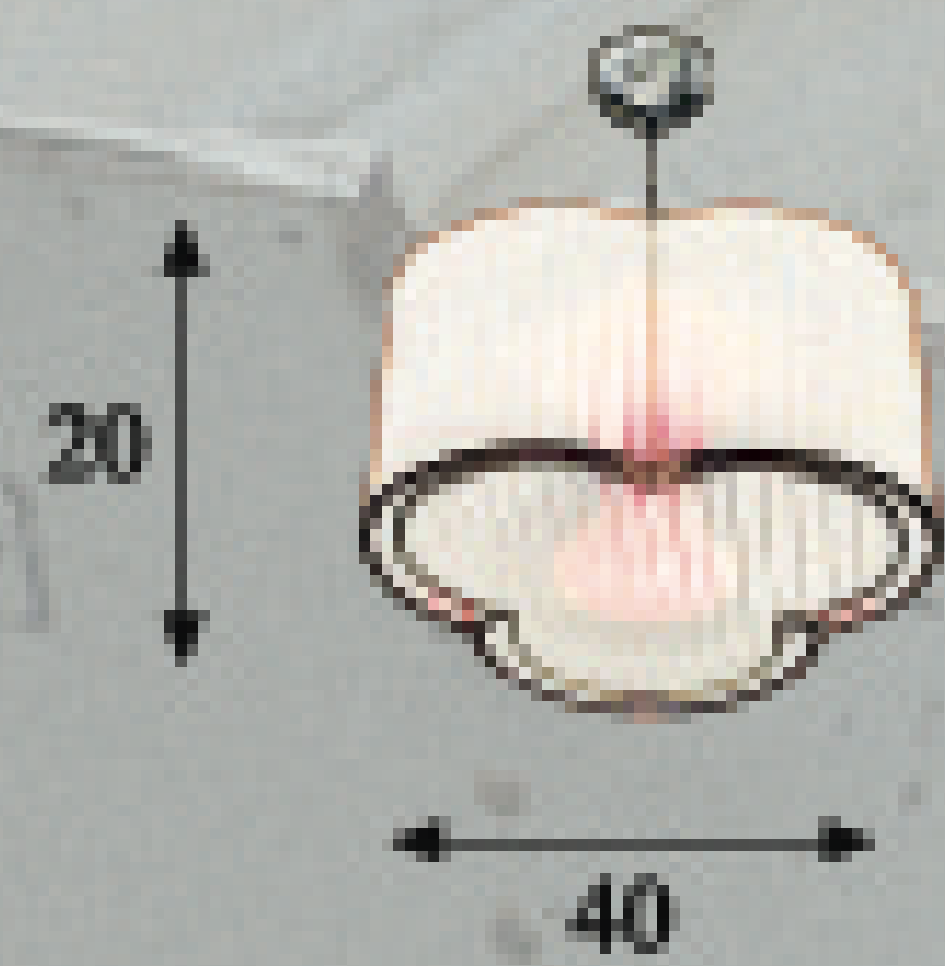

Kod/ Code : T-344
☛ --- 4x20 w

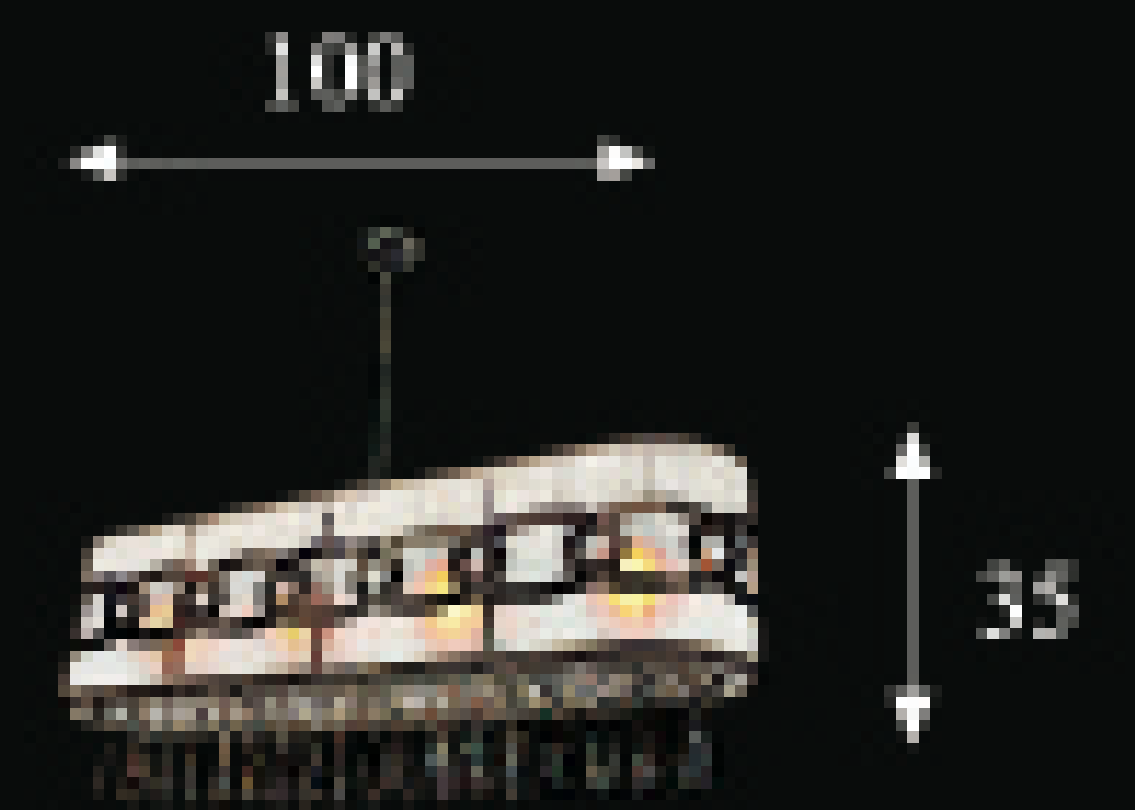
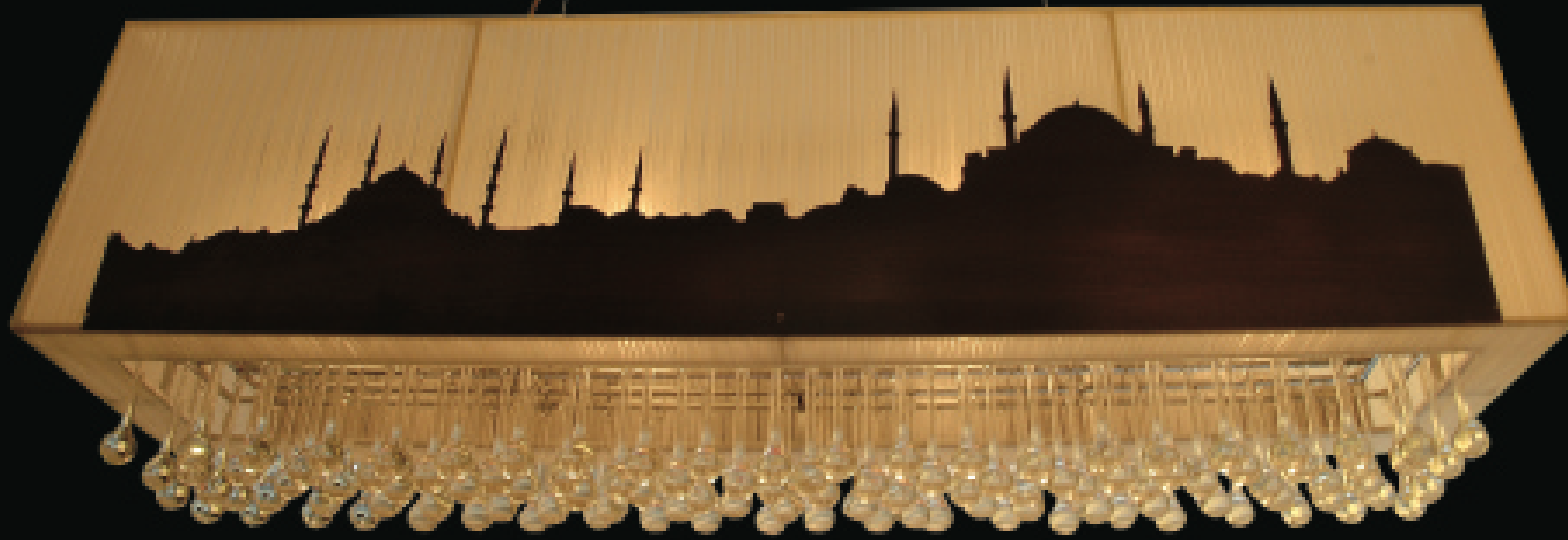

Kod/ Code : T-345
☛ --- 4x20 w

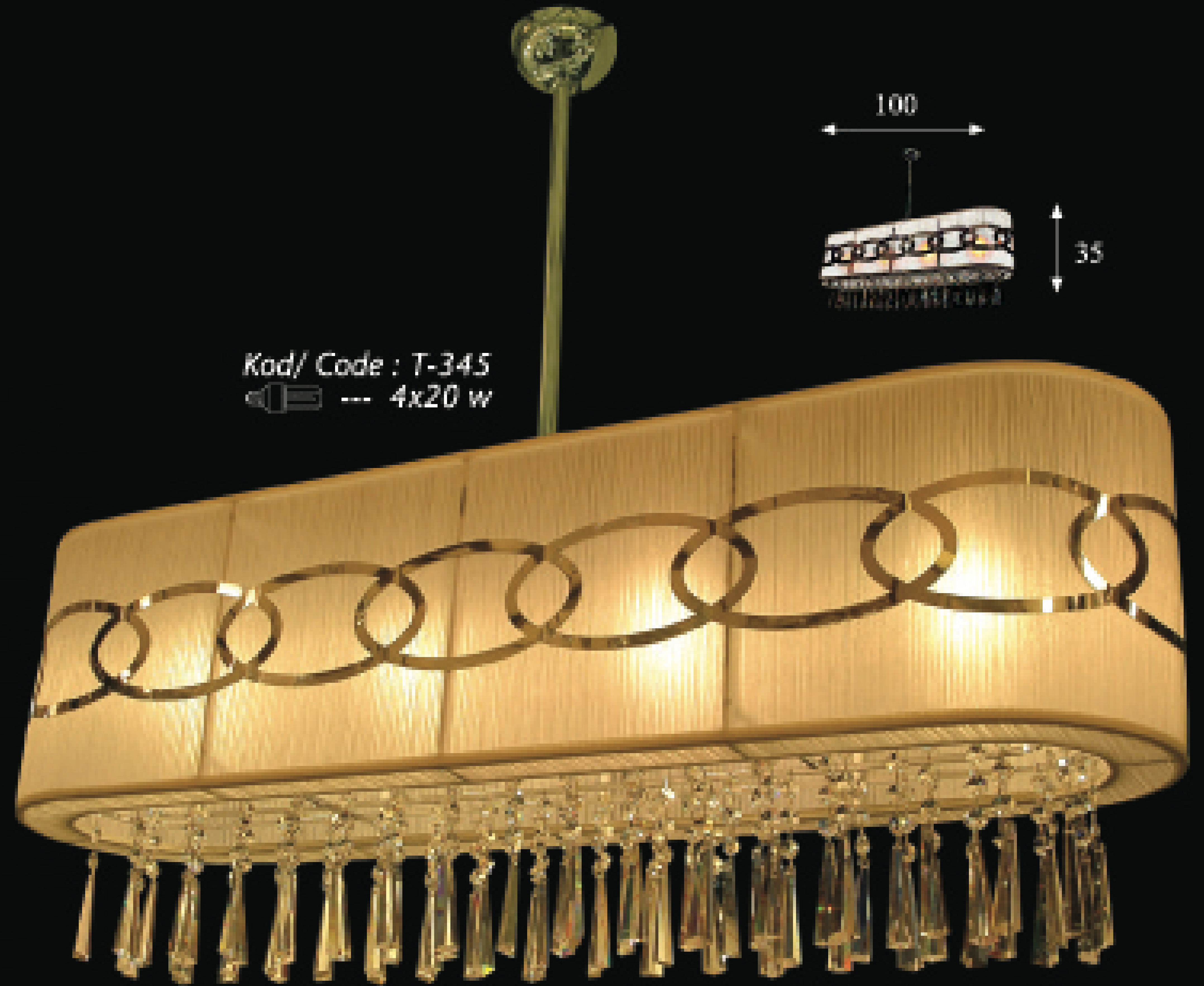

Kod/ Code : T-346
☛ --- 3x15 w



Kod/ Code : T-347
☛ --- 3x20 w

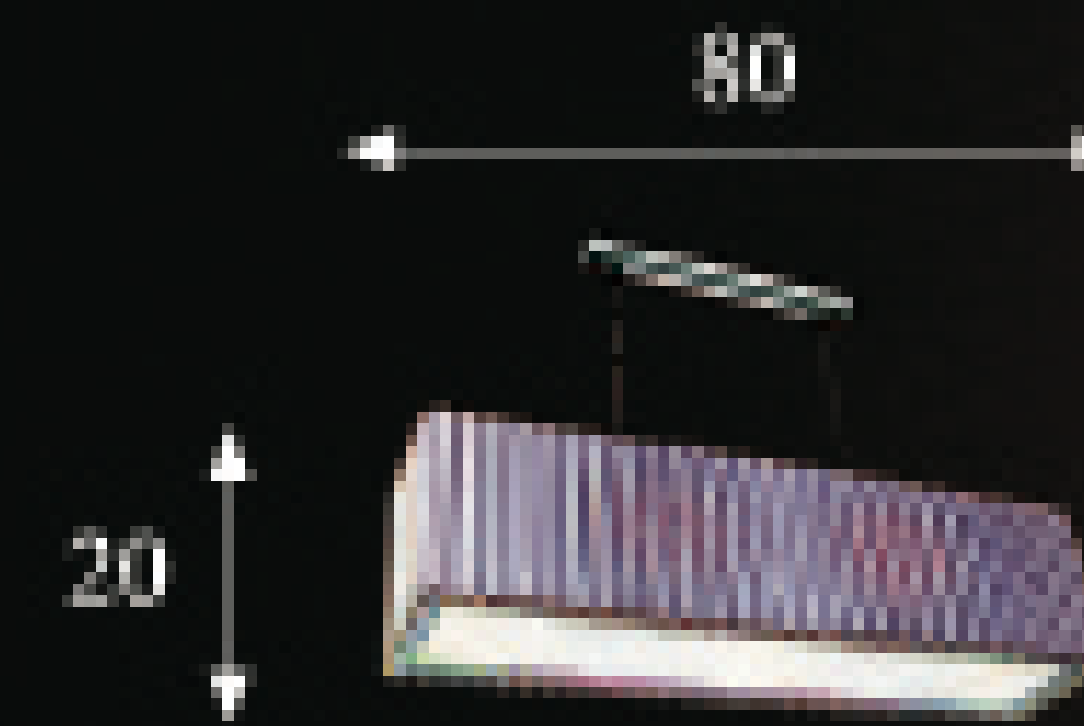

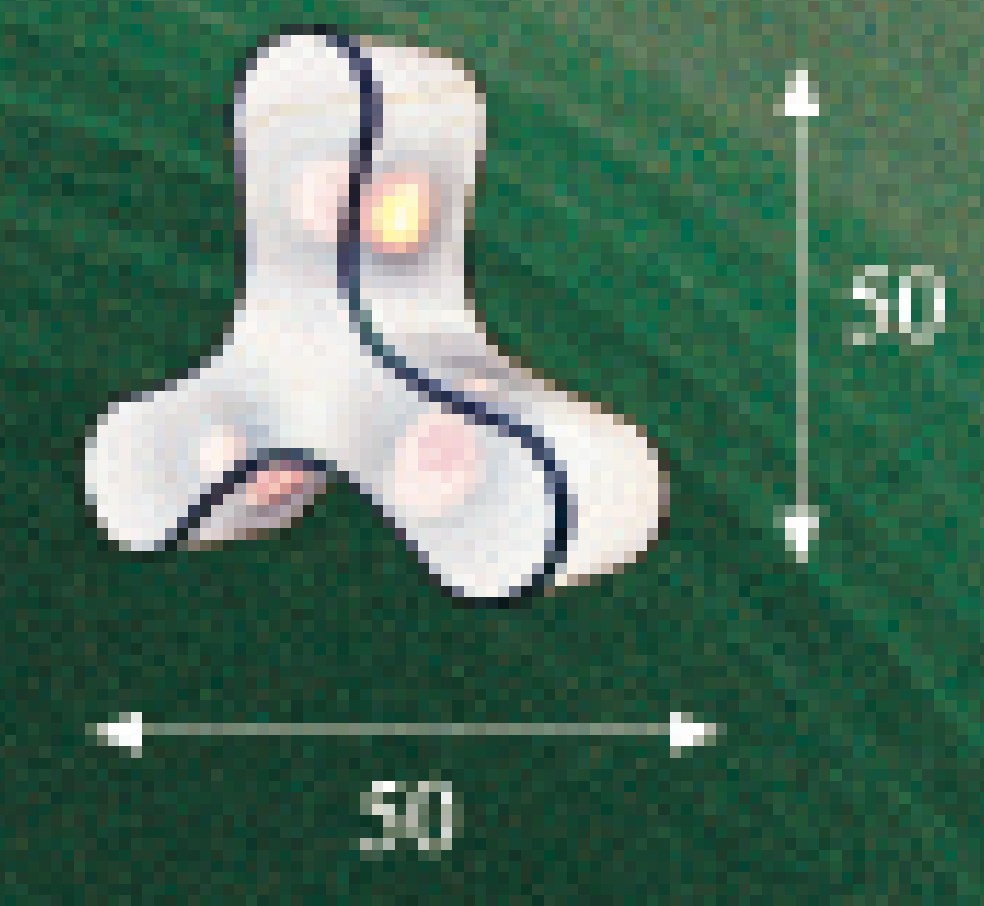
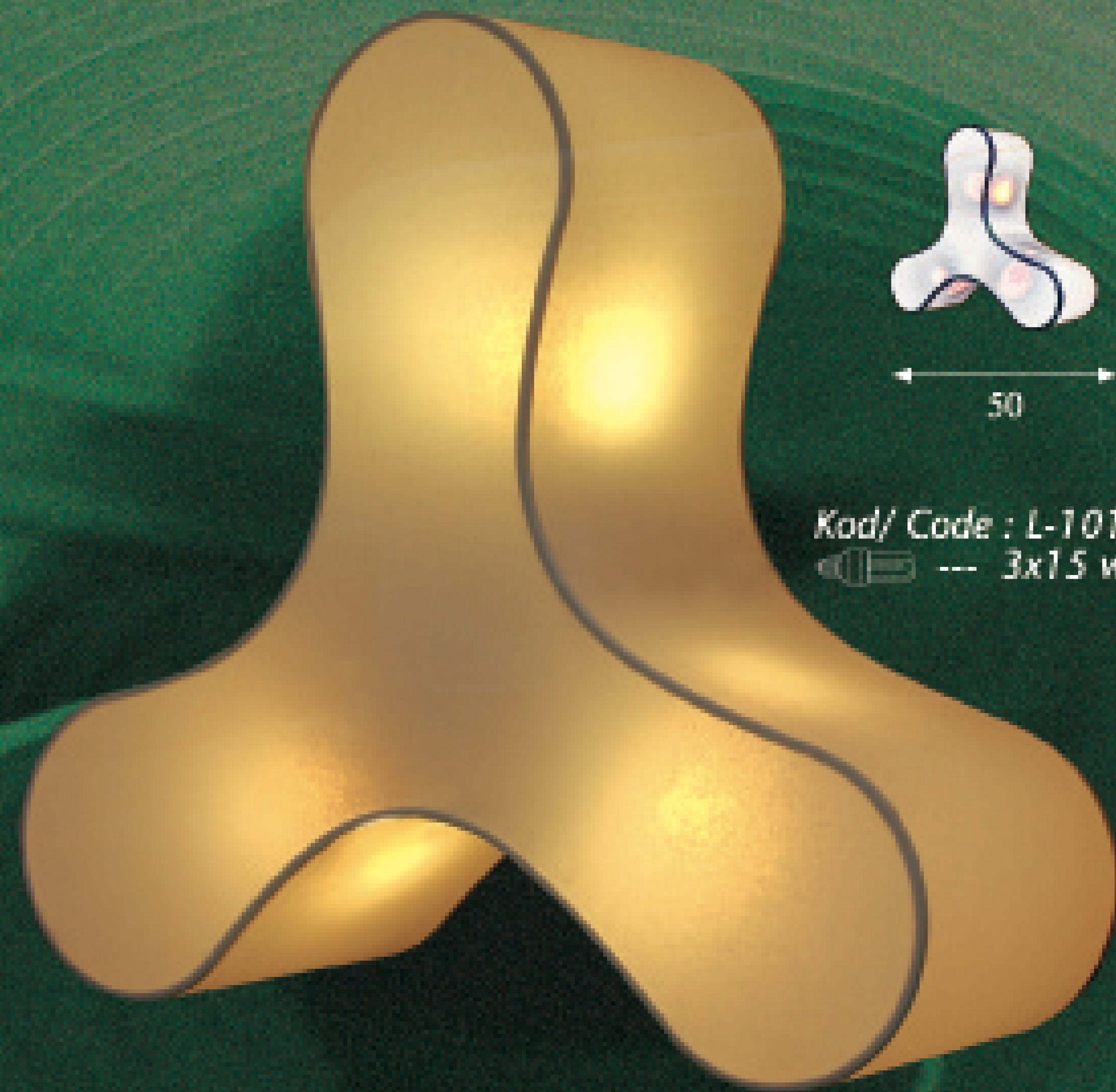
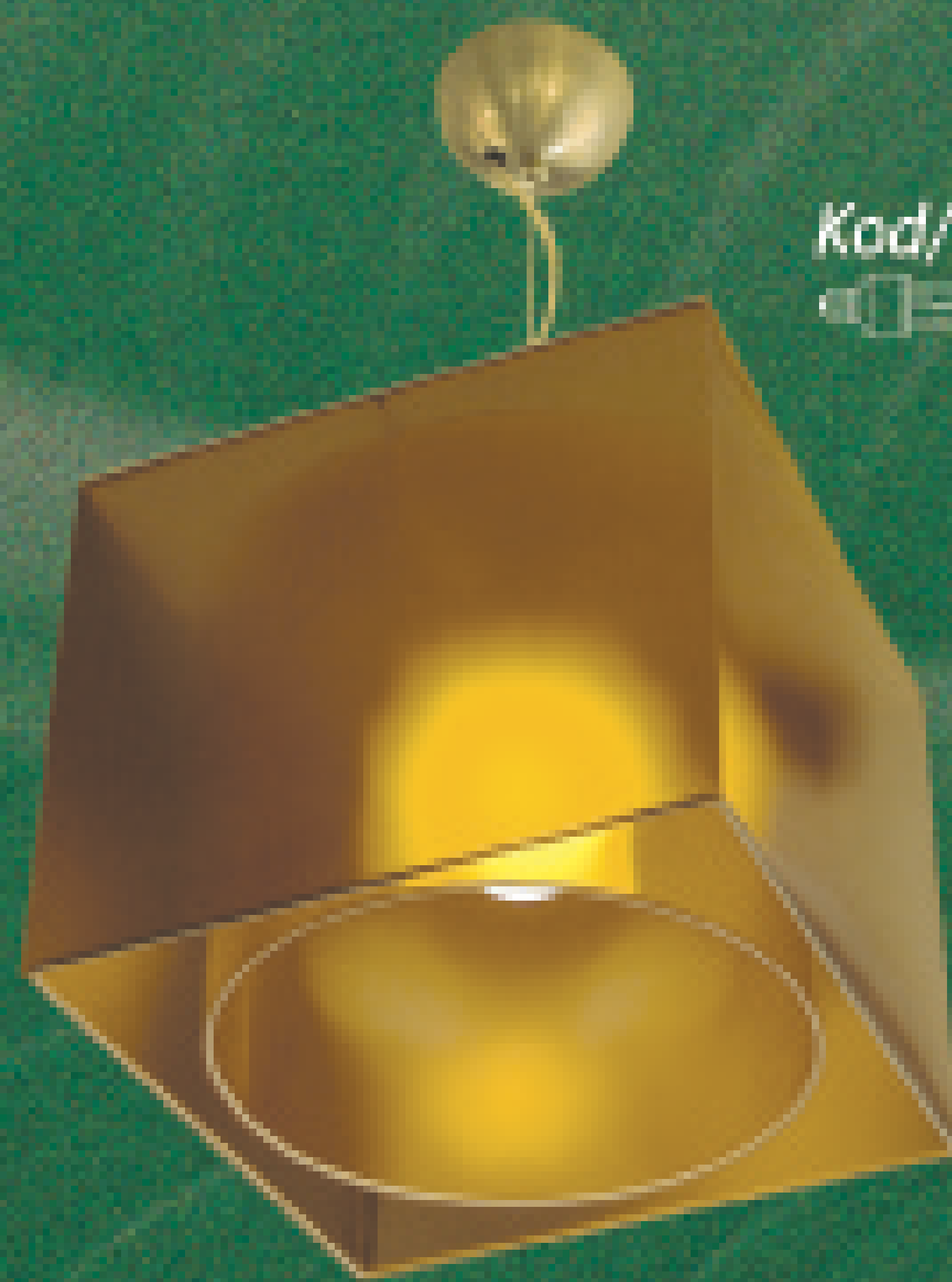
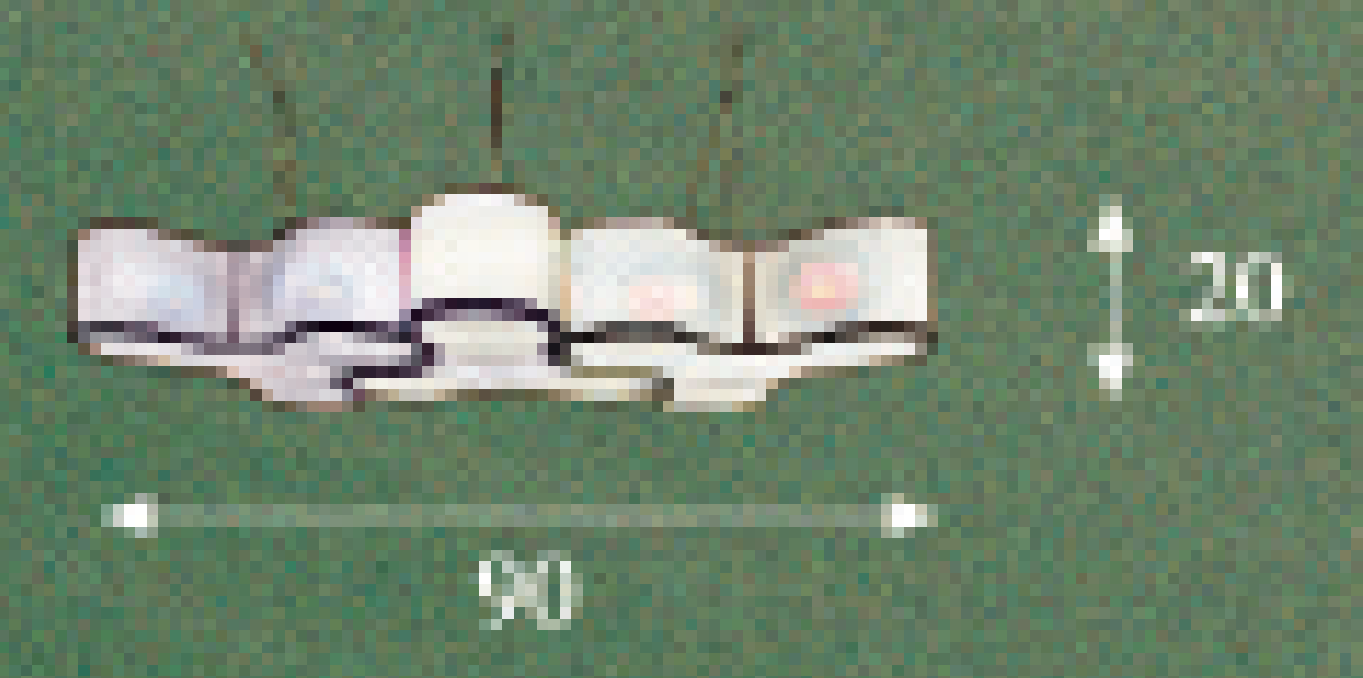

Kod/ Code : T-350
☞☞☞ --- 3x15 w

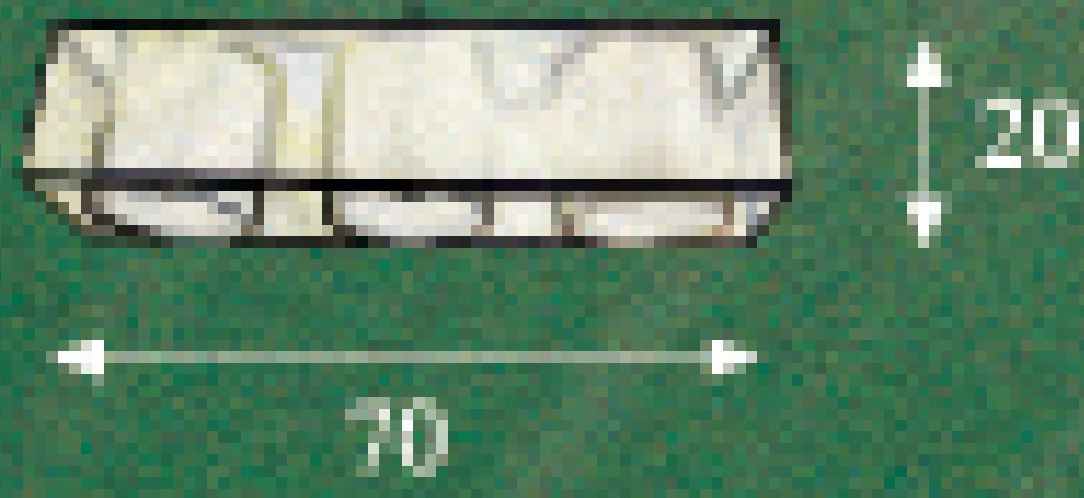

Kod/ Code : T-351
☞☞ --- 2x15 w

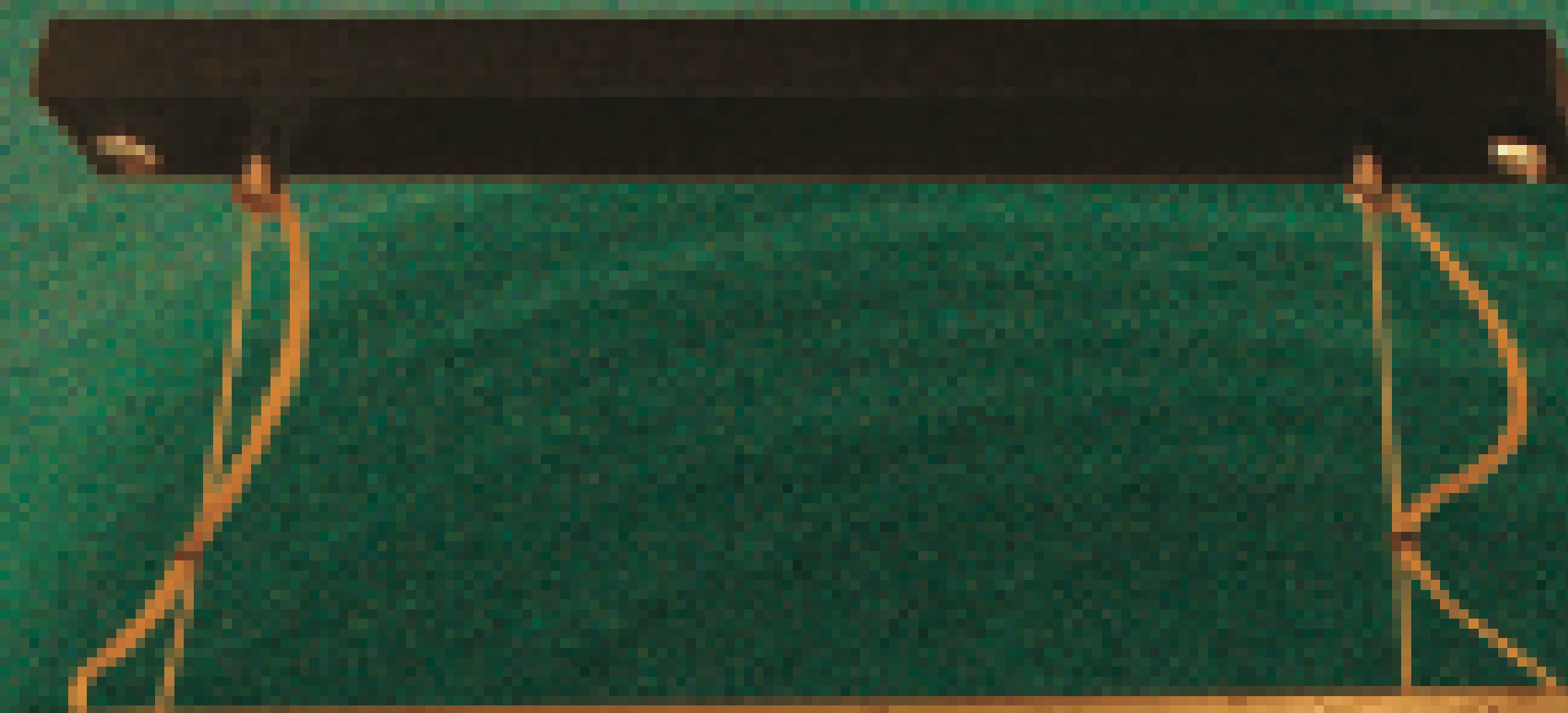



Kod/ Code : T-352
☛ --- 3x15 w



Kod/ Code : T-353
☛ --- 4x20 w

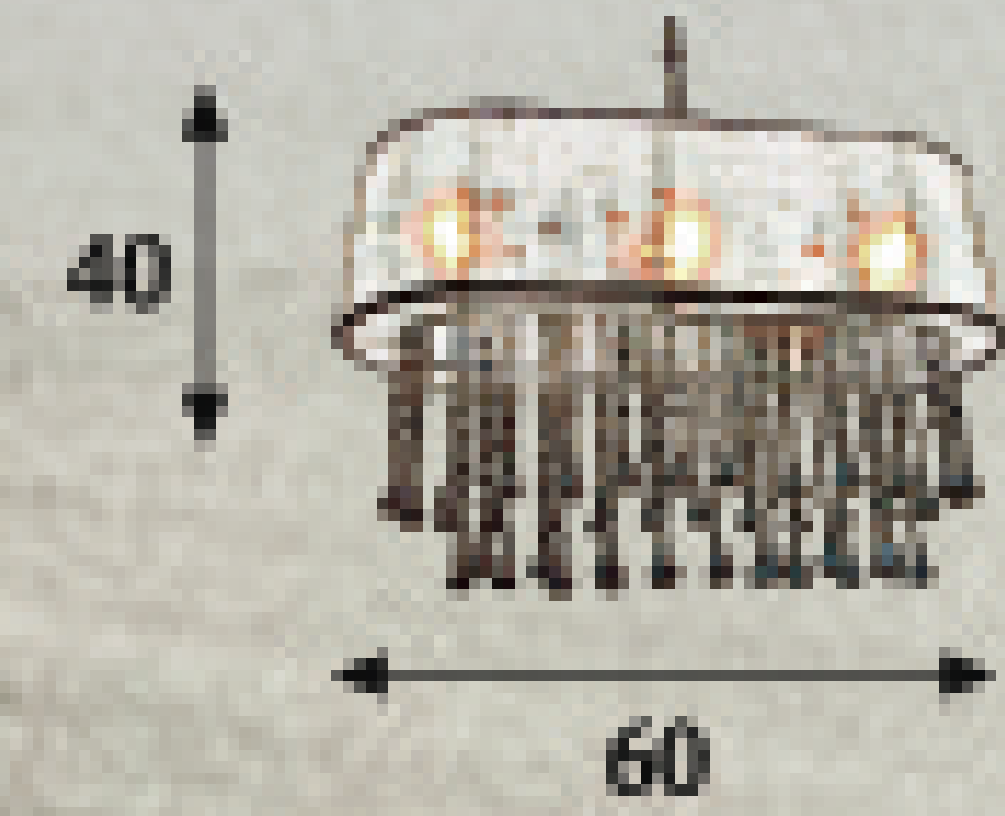

Kod/ Code : T-354
☛ --- 3x15 w

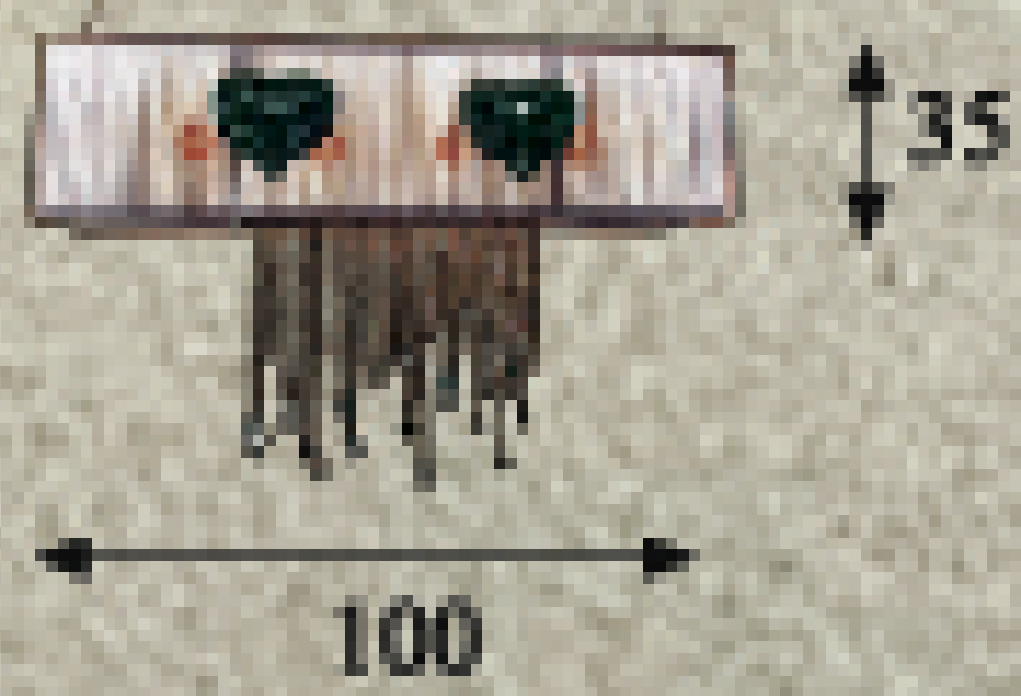

Kod/ Code : T-355
☞ --- 3x20 w



Kod/ Code : T-356
☞ --- 3x20 w



Kod/ Code : T-357
☞ --- 3x15 w

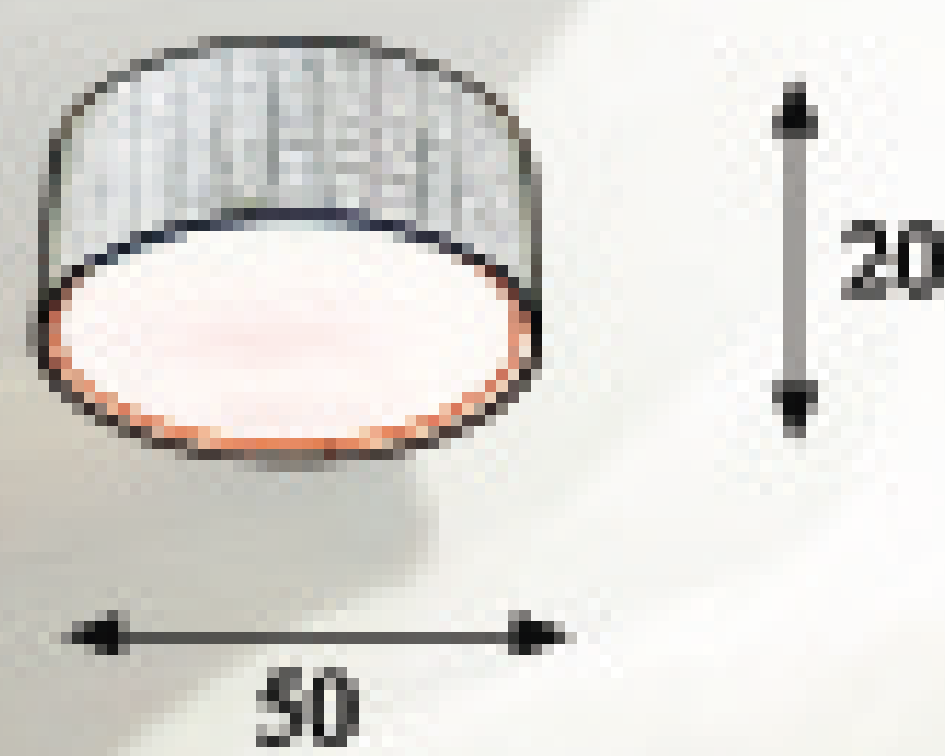



Kod/ Code : T-358
--- 3x20 w



Kod/ Code : T-359
--- 3x15 w



Kod/ Code : T-360
--- 3x20 w

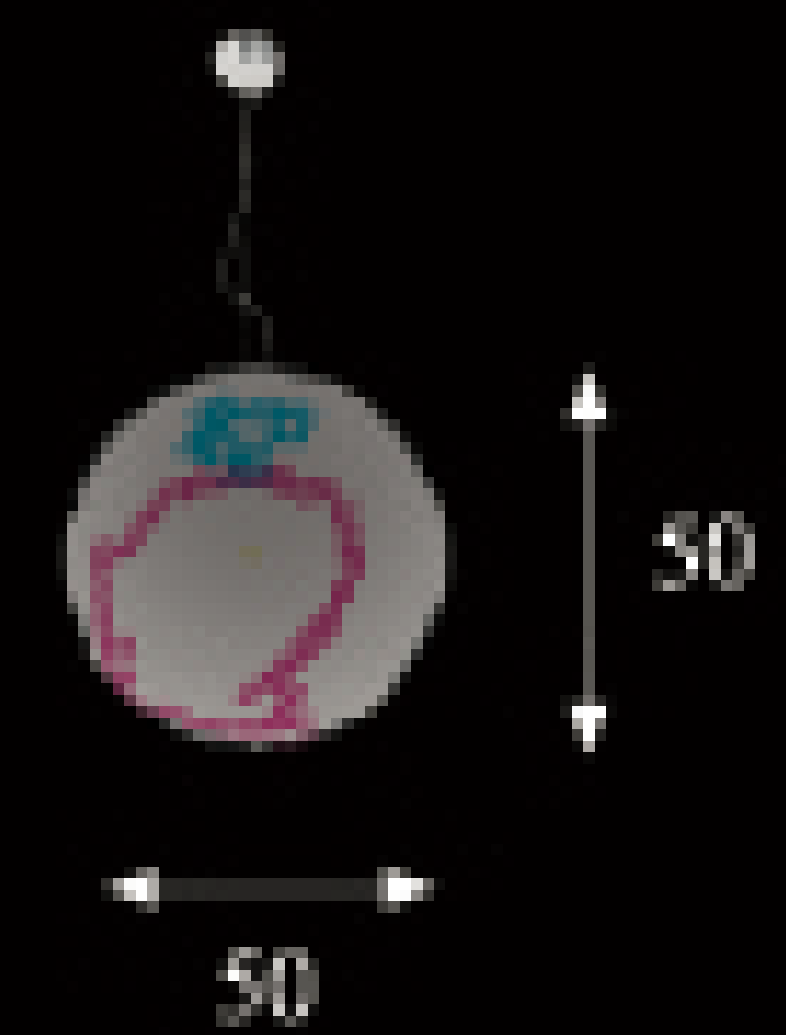
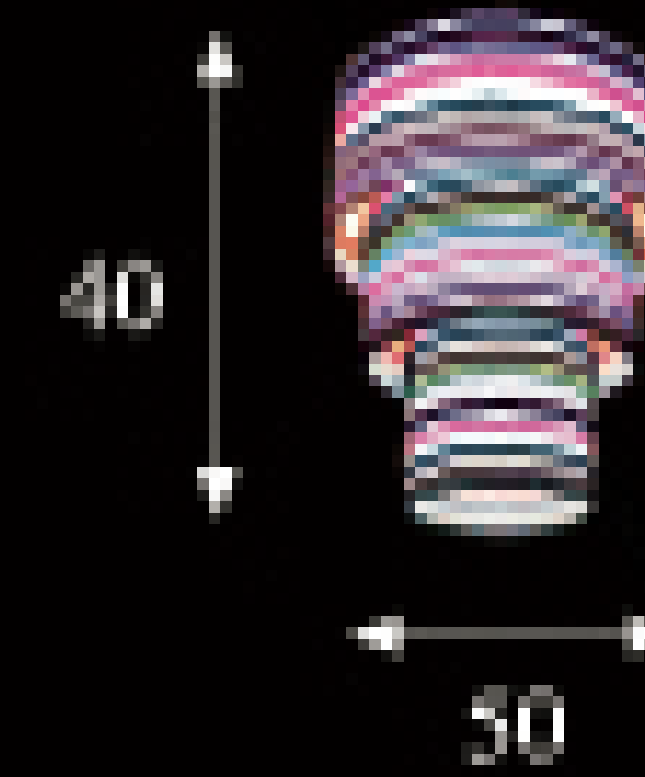



Kod/ Code : T-361
☞☞☞ --- 3x20 w



Kod/ Code : A-402
☞☞☞ --- 1x15 w



Kod/ Code : L-102
☞☞☞ --- 1x20 w



Kod/ Code : A-403
☞☞☞ --- 1x15 w



Kod/ Code : M-203
☞☞☞ --- 1x20 w

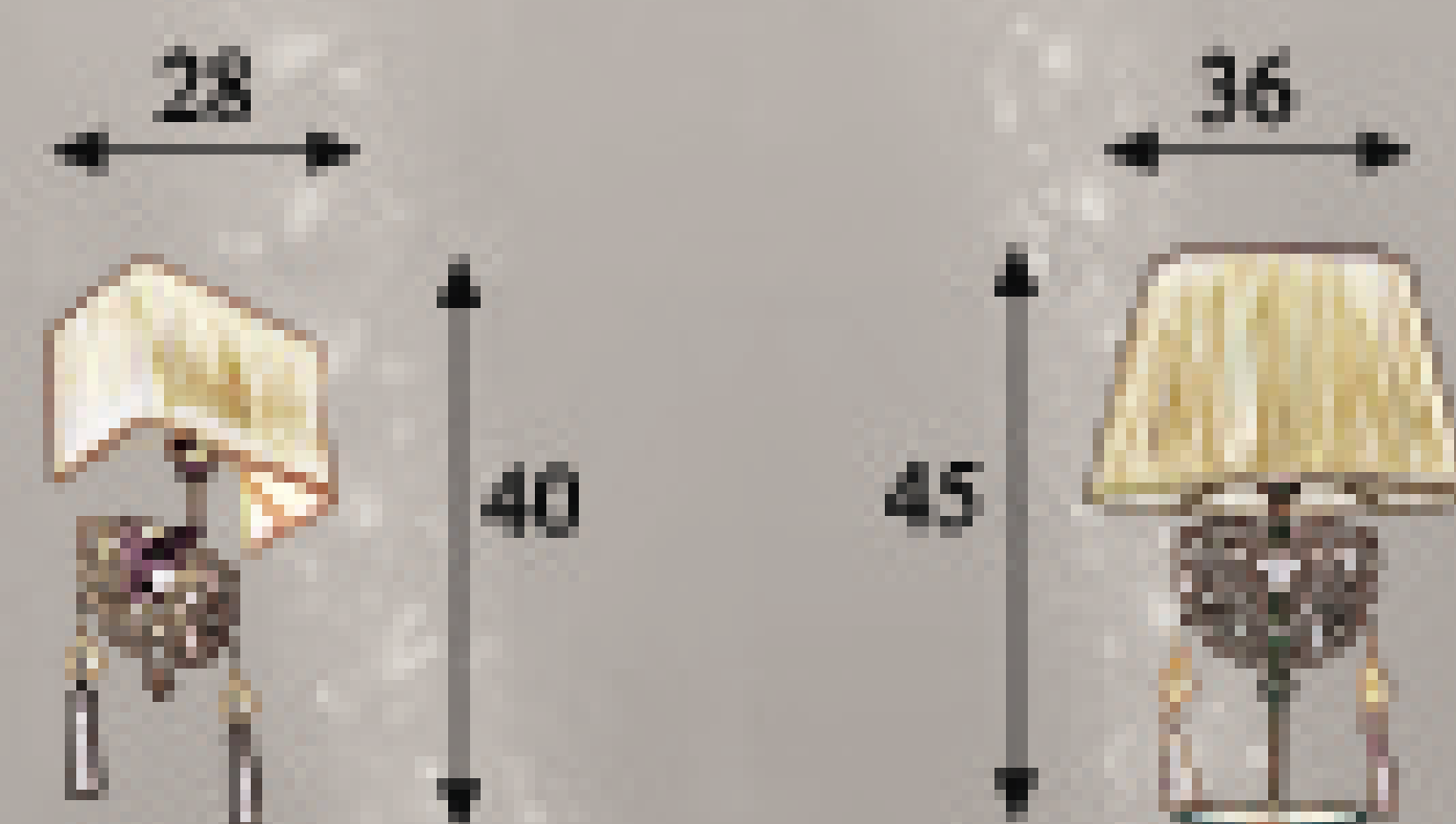







Kod/ Code : L-105
☞ --- 3x15 w

Kod/ Code : A-404
☞ --- 3x15 w

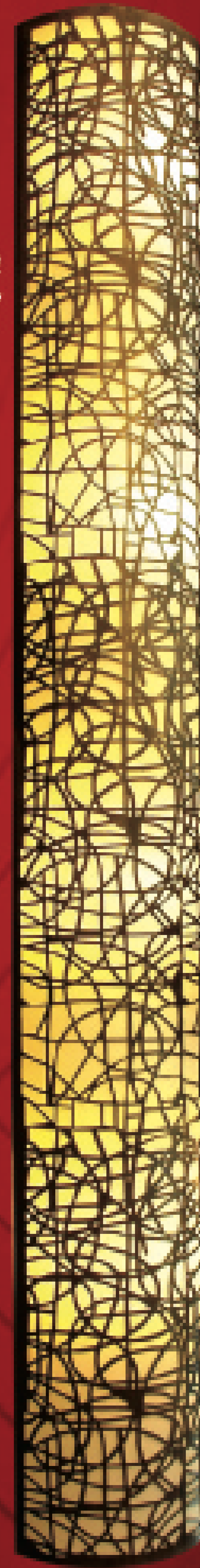

Kod/ Code : A-405
☞ --- 1x20 w

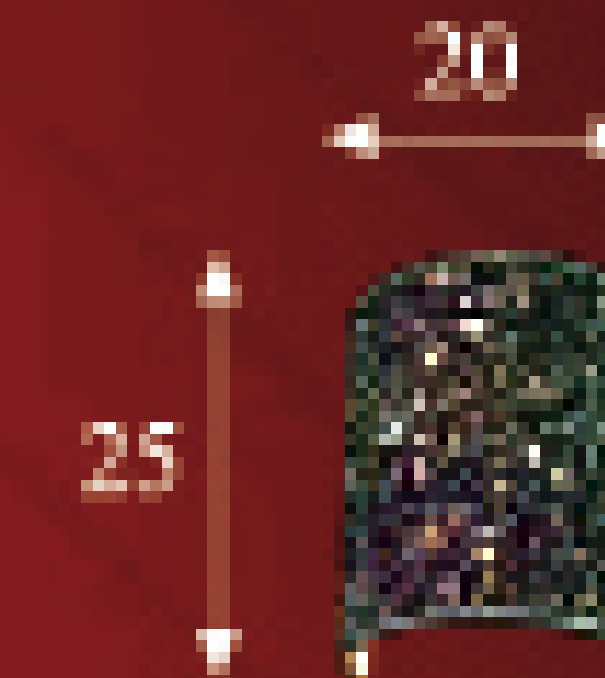

Kod/ Code : M-205
☞ --- 1x20 w

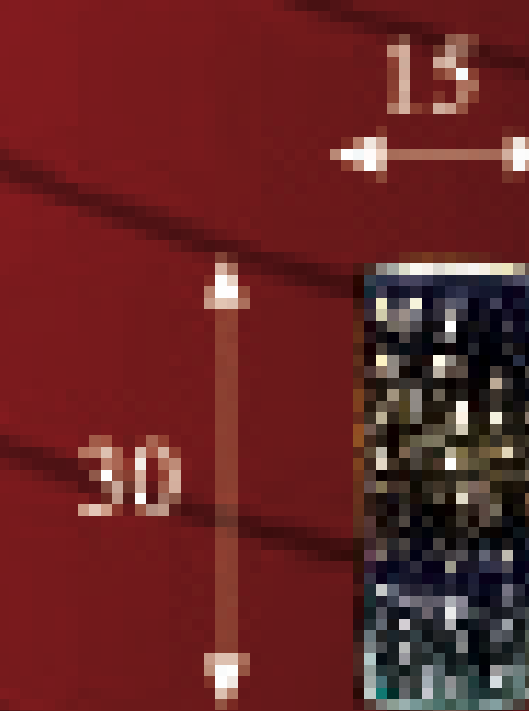

Kod/ Code : M-206
☞ --- 1x20 w

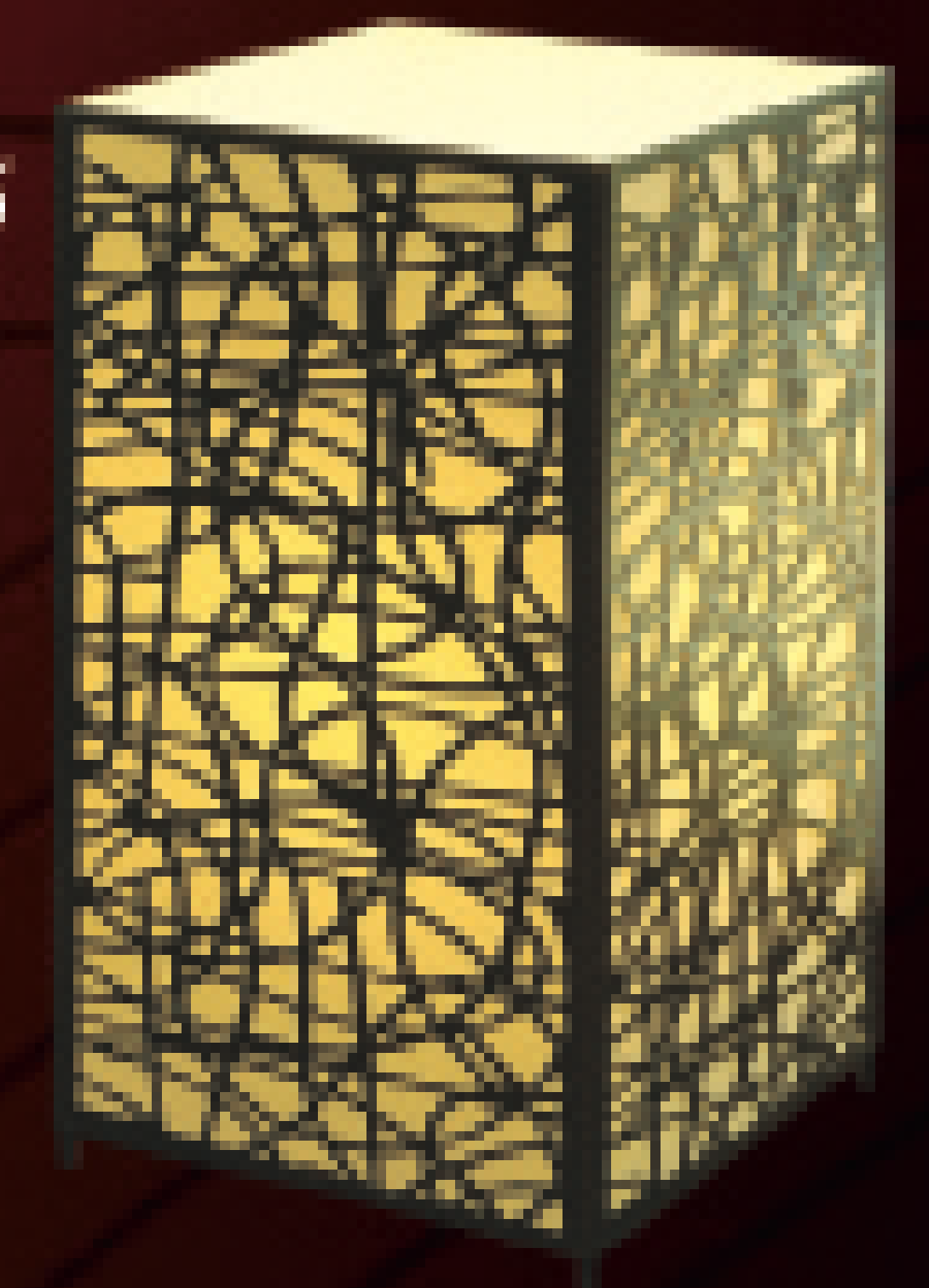
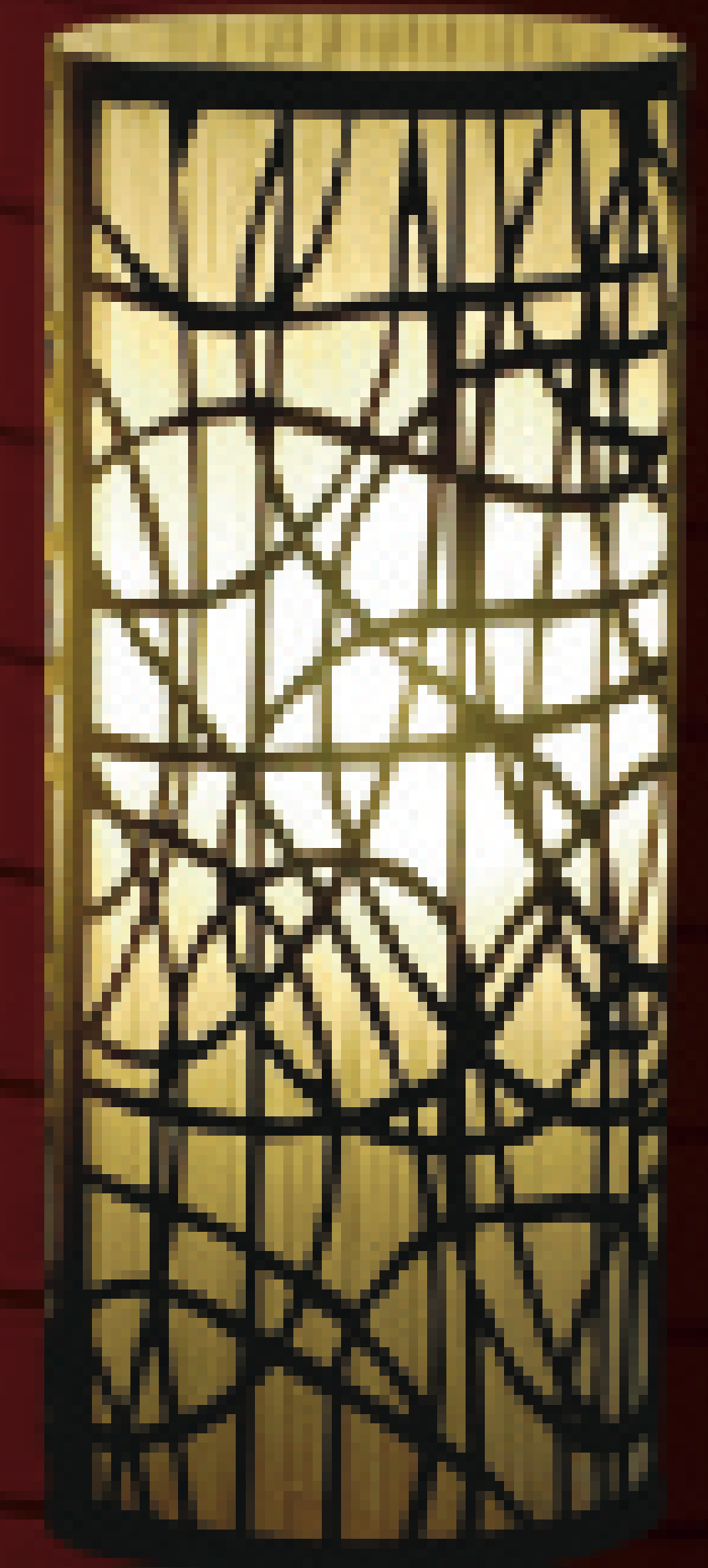
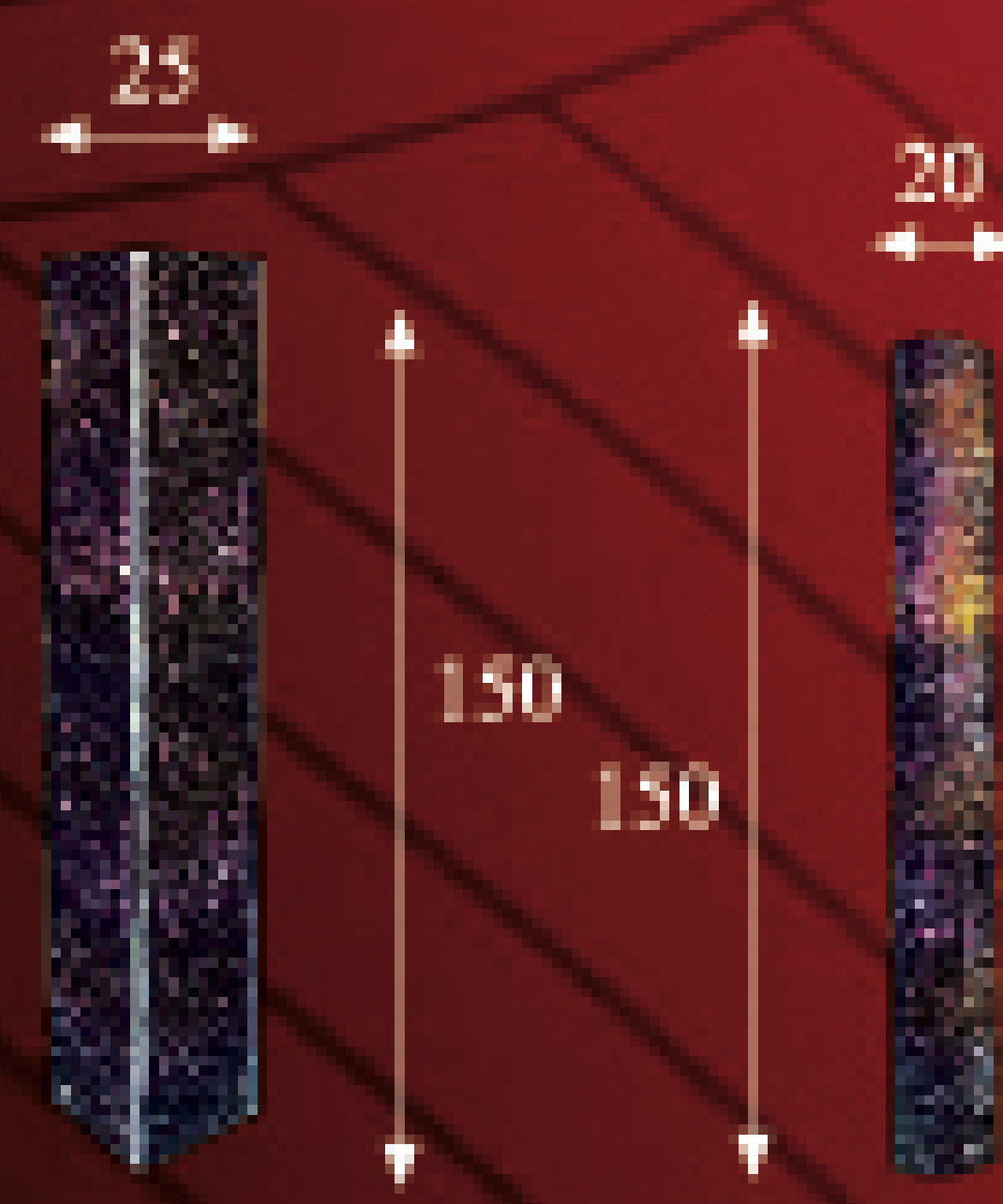
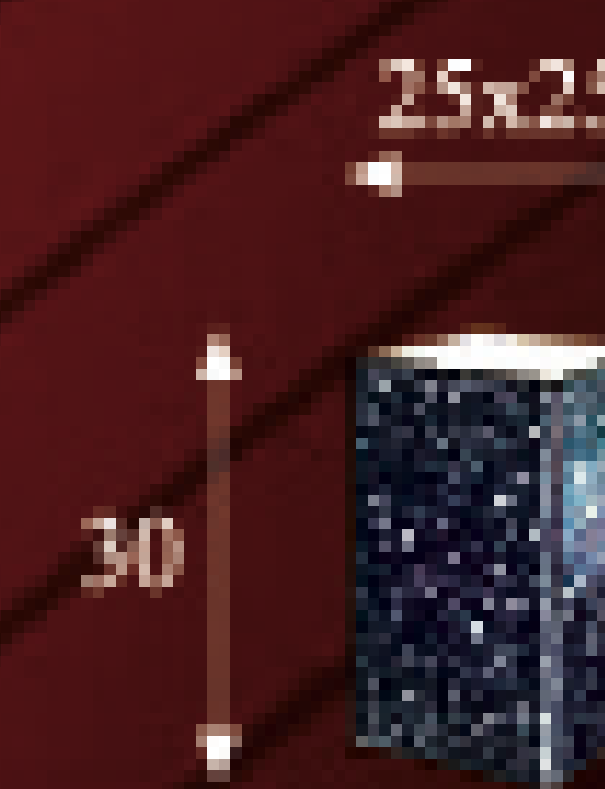



Kod/ Code : L-106
☛ --- 1x20 w



Kod/ Code : L-107
☛ --- 1x20 w



Kod/ Code : L-108
☛ --- 1x20 w

Kod/ Code : L-109
☛ --- 1x20 w

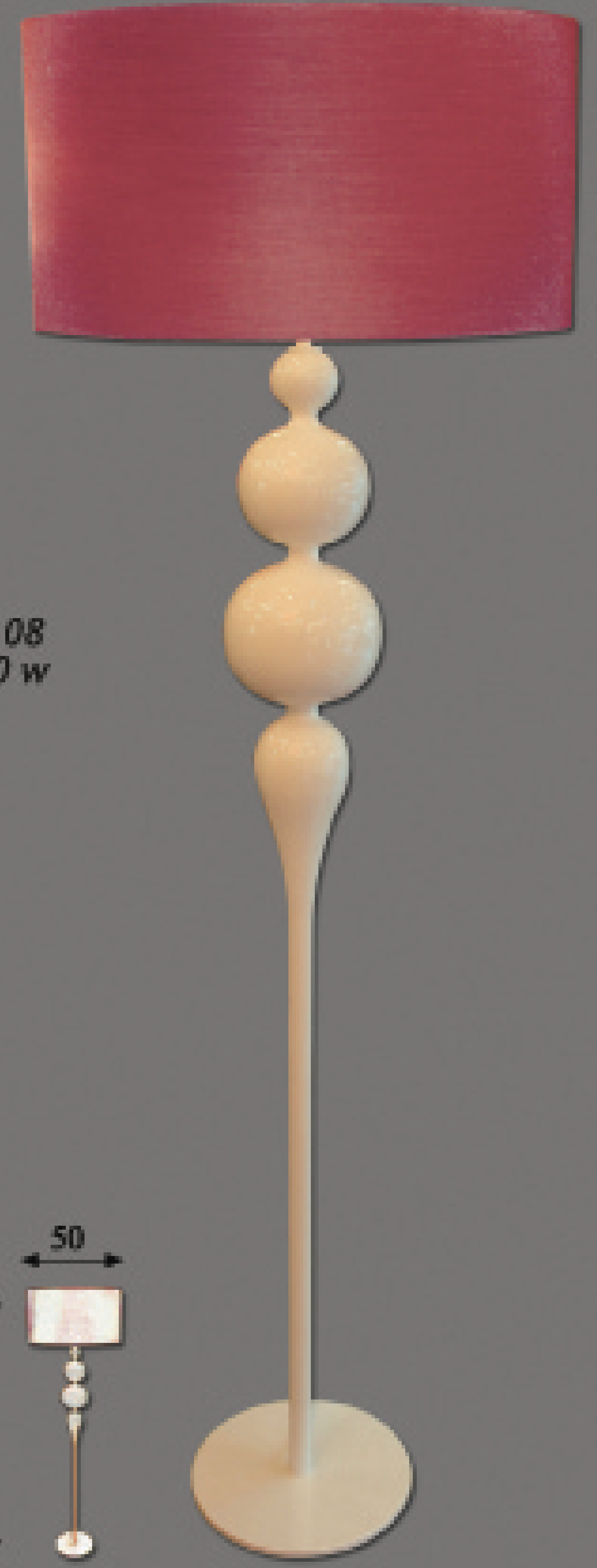



Kod/ Code : L-110
☛ --- 1x20 w

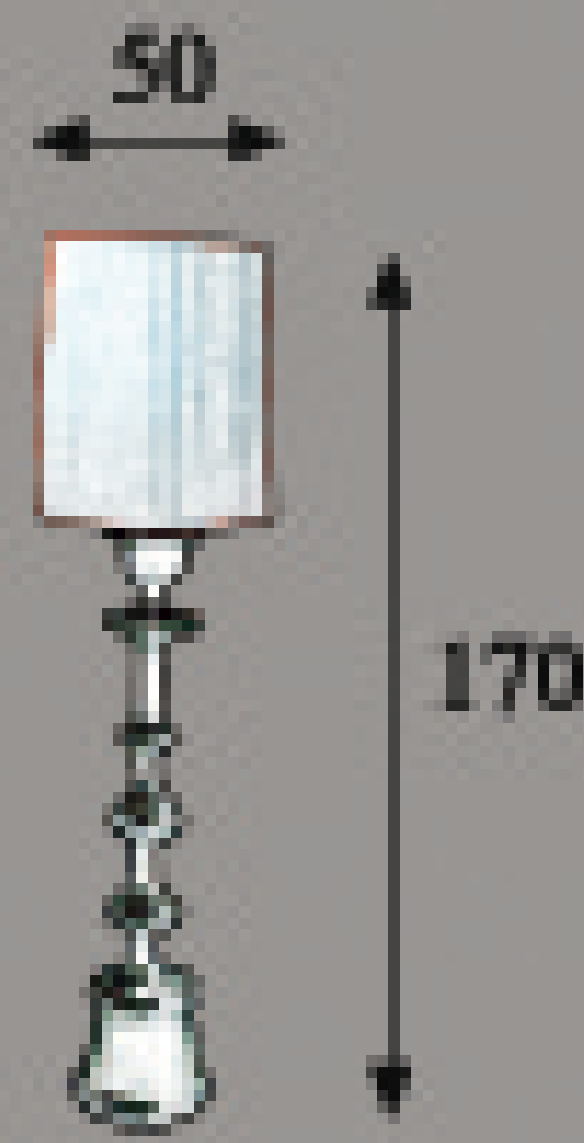

Kod/ Code : M-207
☛ --- 1x20 w



Kod/ Code : L-111
☛ --- 1x20 w





Kod/ Code : L-112
☛ --- 1x20 w

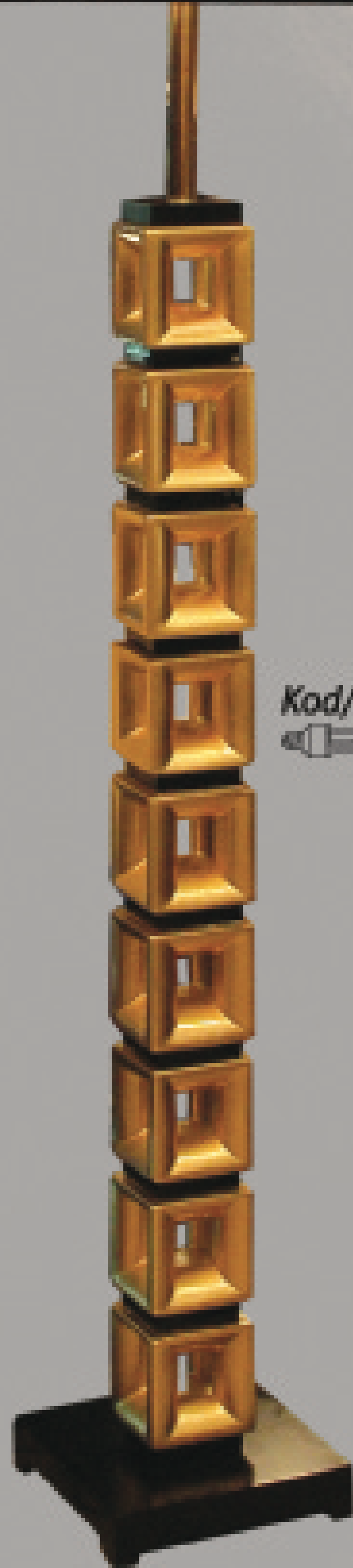

Kod/ Code : M-208
☛ --- 1x20 w

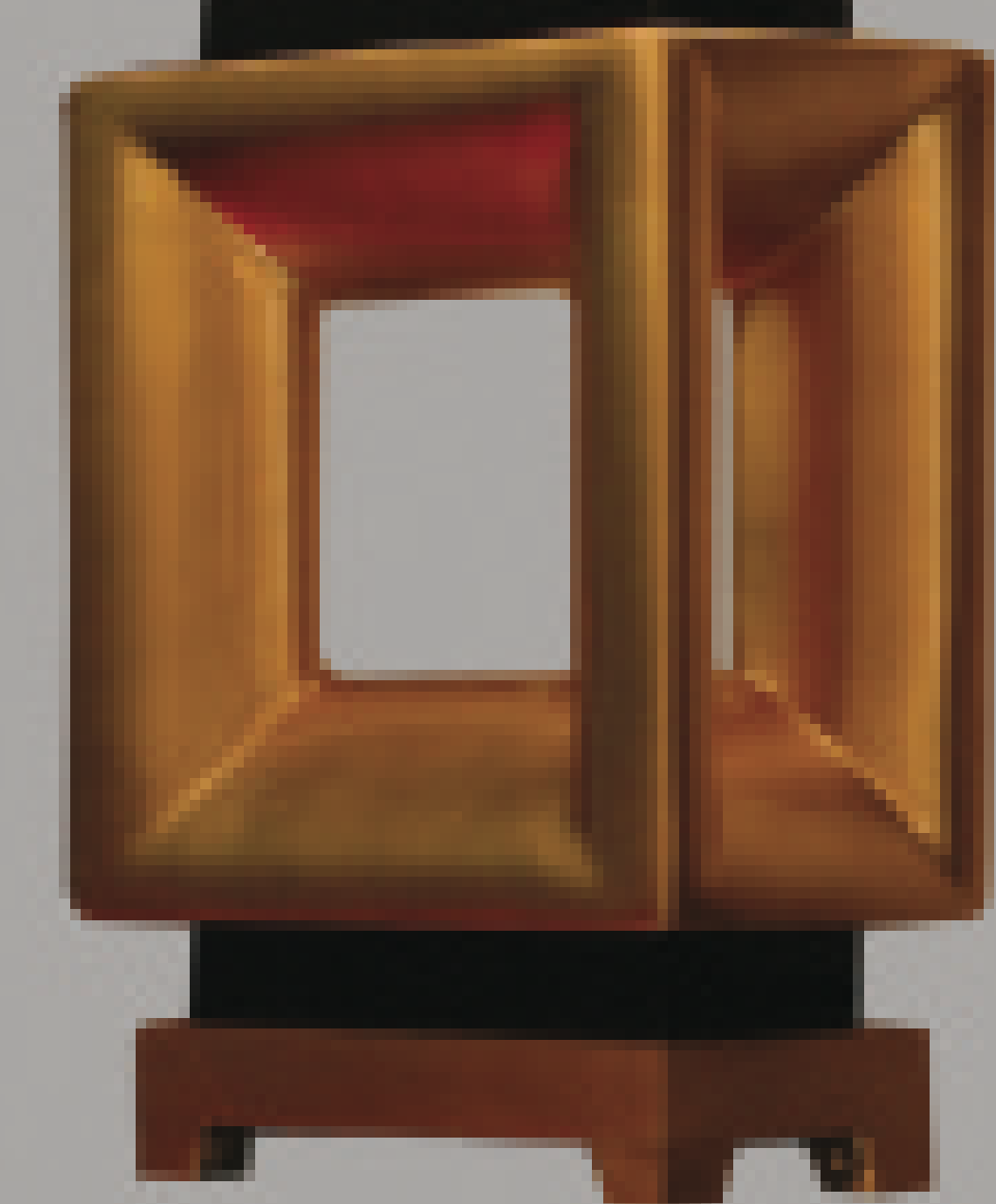

Kod/ Code : M-209
☛ --- 1x20 w





Kod/ Code : L-113
☞☞ --- 1x20 w

50



170



Kod/ Code : T-362
☞☞ --- 1x20 w



Kod/ Code : M-210
☞☞ --- 1x15 w



Kod/ Code : M-211
☞☞ --- 1x15 w

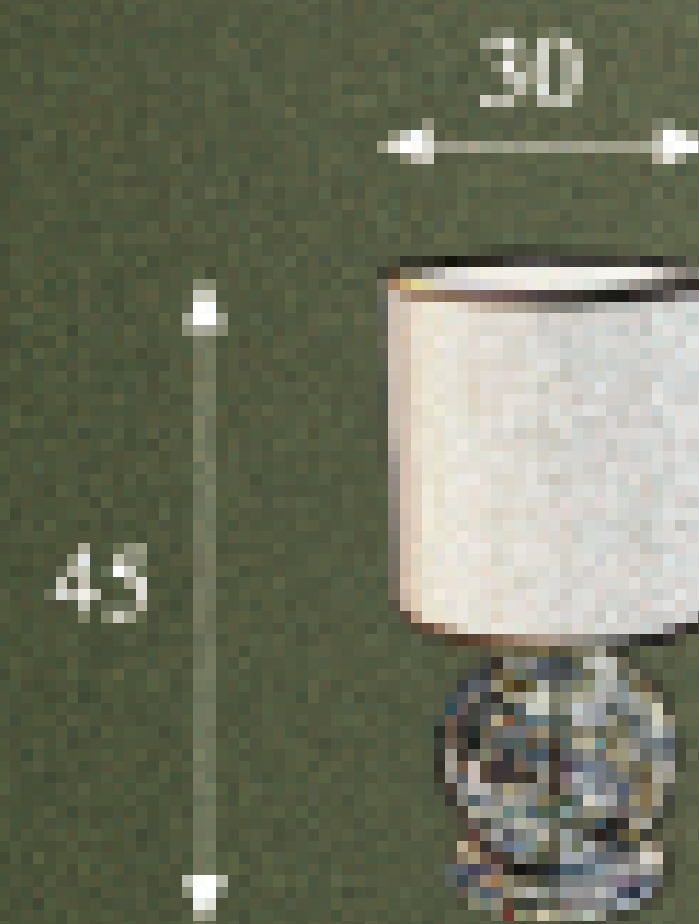



Kod/ Code : T-363
☞☛ --- 6x15 w

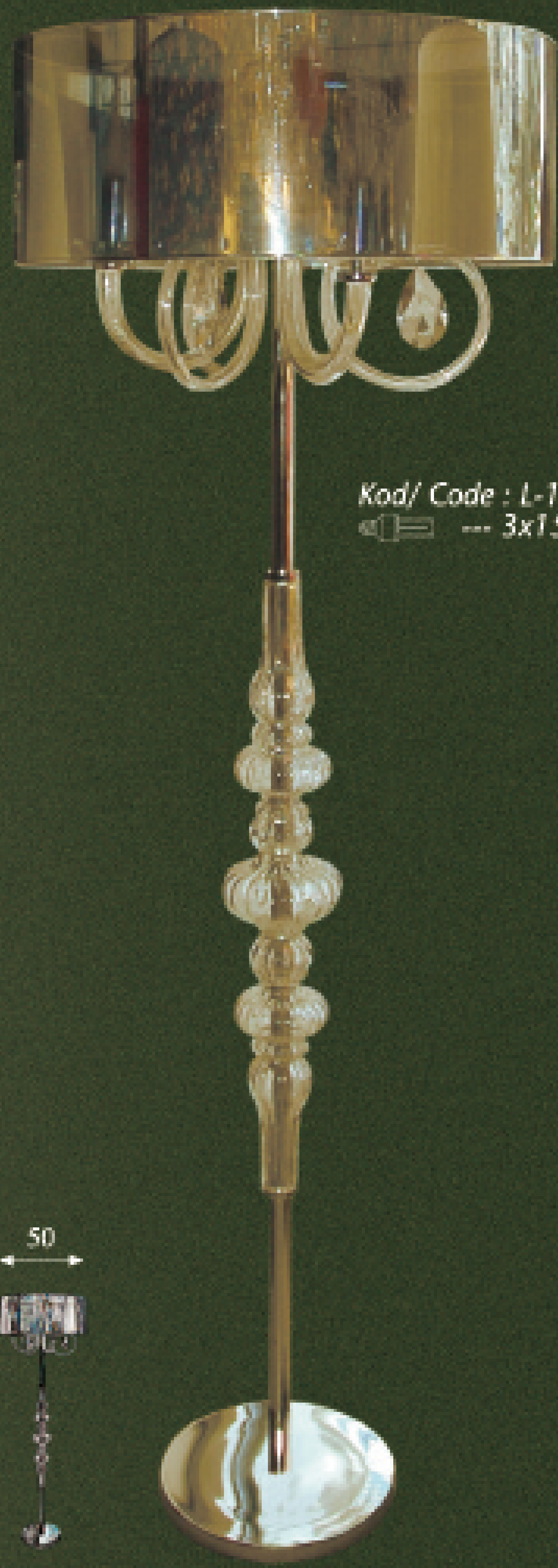

Kod/ Code : L-114
☞☛ --- 3x15 w



Kod/ Code : L-115
☞☞ --- 3x15 w

35

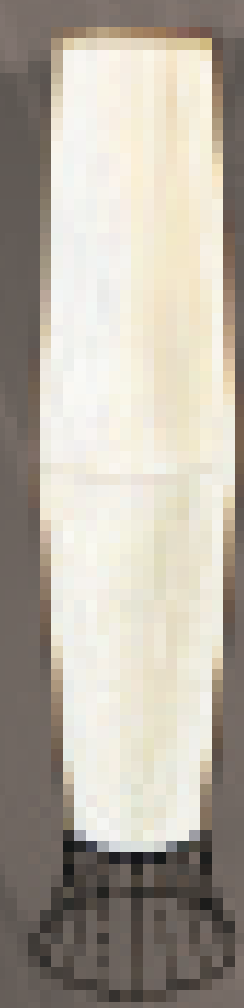

160

30

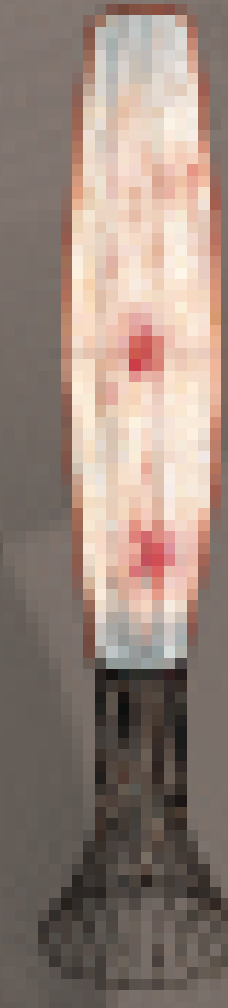

150



Kod/ Code : L-116
☞☞ --- 3x15 w

☞☞

☞☞



Kod/ Code : M-212
☞ --- 1x15 w



Kod/ Code : L-117
☞ --- 1x18 w



Kod/ Code : M-213
☞ --- 1x15 w

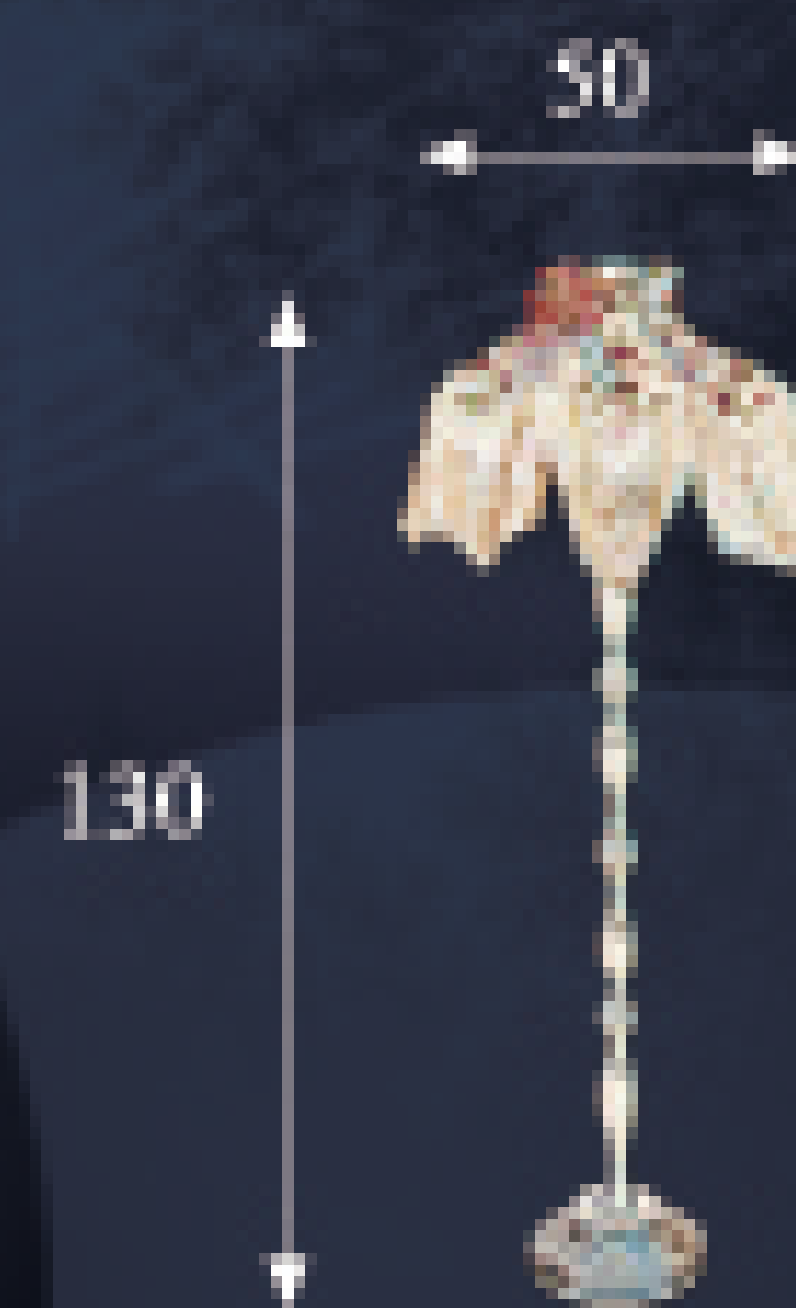



Kod/ Code : L-118
☛ — 2x20 w

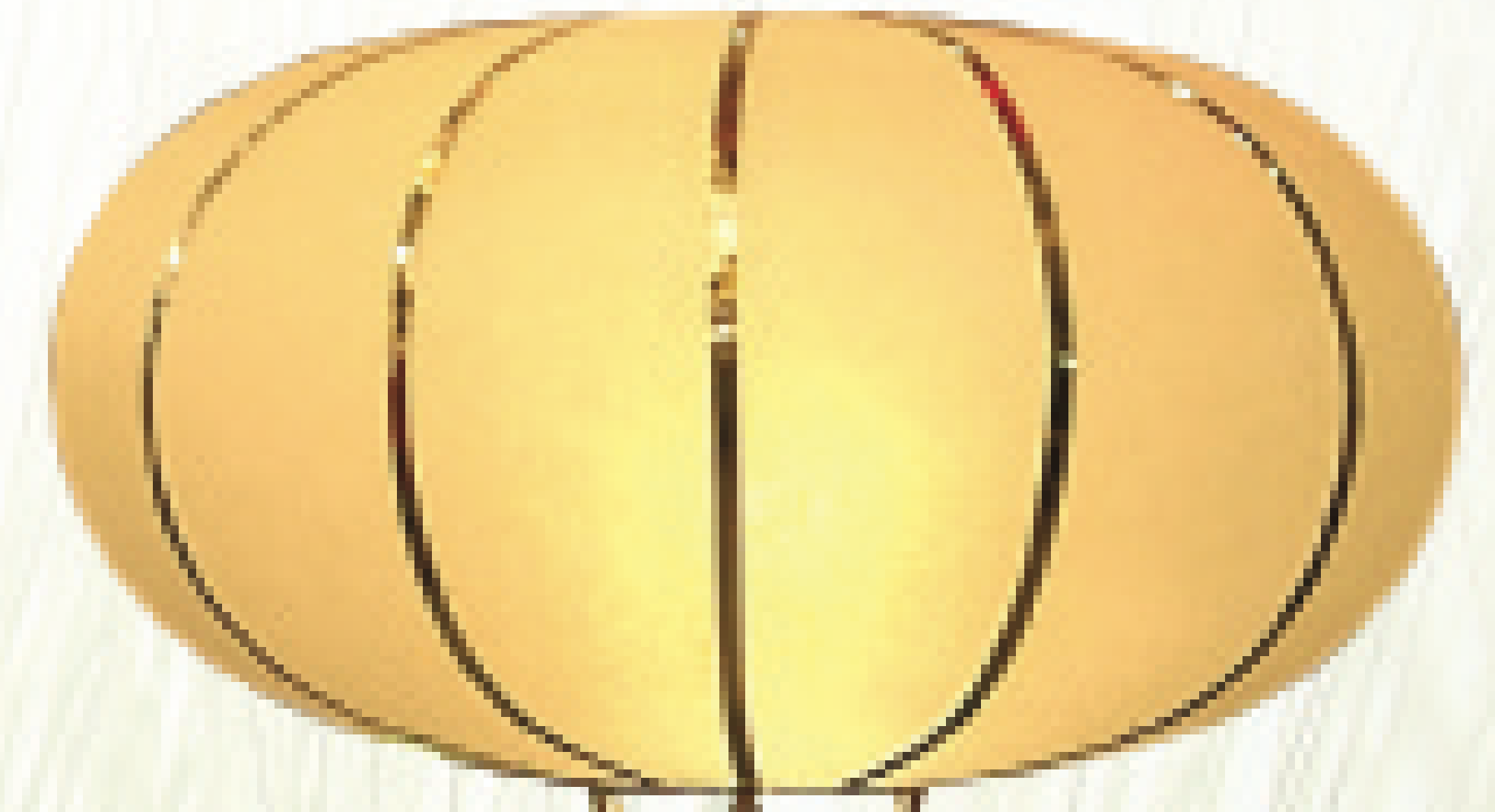

Kod/ Code : L-119
☛ — 2x20 w





Kod/ Code : L-120
☛ --- 1x20 w



Kod/ Code : L-121
☛ --- 1x20 w

Kod/ Code : M-214
☛ --- 1x20 w



Kod/ Code : M-215
☛ --- 1x20 w





Kod/ Code : L-122
💡 --- 2x15 w



Kod/ Code : M-216
💡 --- 1x15 w





Kod/ Code : A-406
☑️ — 1x15 w

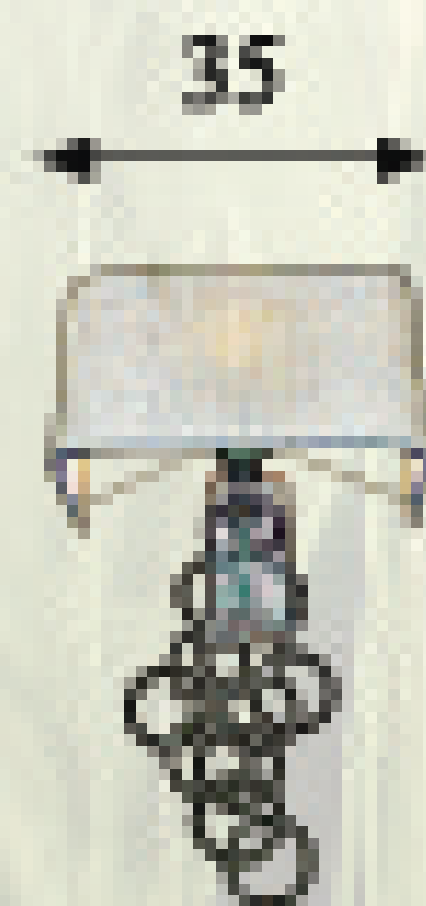

Kod/ Code : L-123
☑️ — 1x20 w







Kod/ Code : L-124
☛ --- 1x20 w

Kod/ Code : M-217
☛ --- 1x15 w



Kod/ Code : L-125
--- 1x20 w

40



160

35



55

50



170



Kod/ Code : L-126
☛ --- 2x15 w



Kod/ Code : M-218
☛ --- 1x20 w

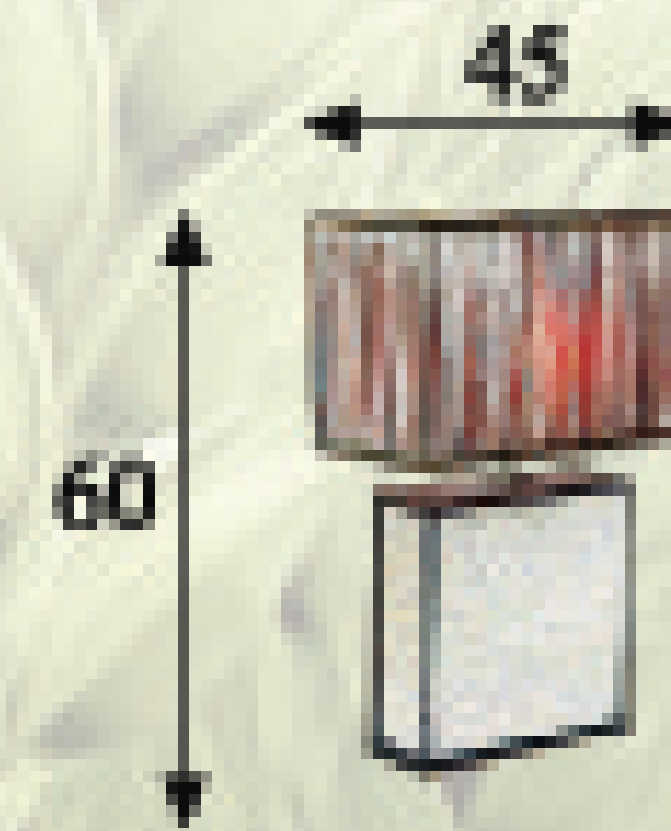

Kod/ Code : M-219
☛ --- 1x20 w







Kod/ Code : L-127
☛ --- 1x20 w

Kod/ Code : L-128
☛ --- 1x20 w

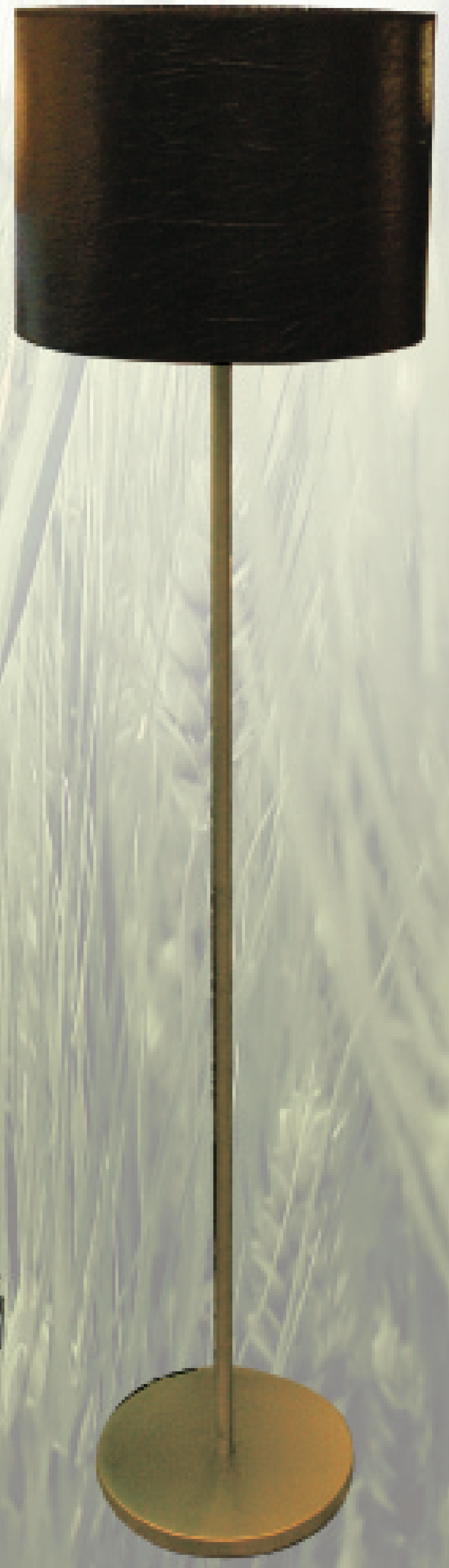

Kod/ Code : M-220
☛ --- 1x15 w



Kod/ Code : M-221
☛ --- 1x15 w

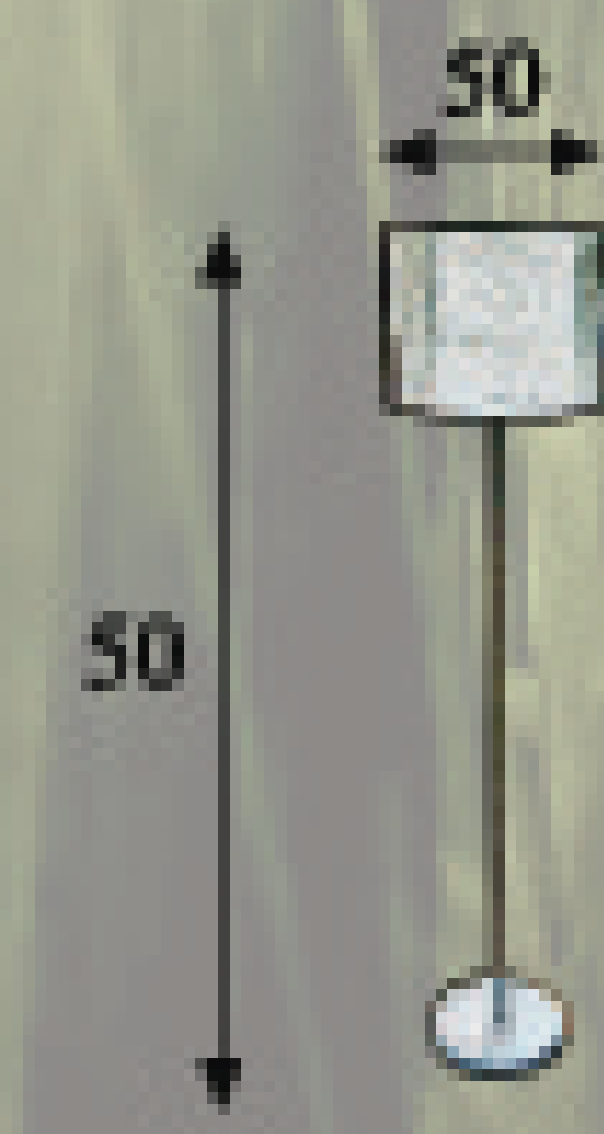



Kod/ Code : L-129
☞ --- 1x20 w

Kod/ Code : L-130
☞ --- 1x20 w



Kod/ Code : M-222
☞ --- 1x15 w



Kod/ Code : M-223
☞ --- 1x15 w

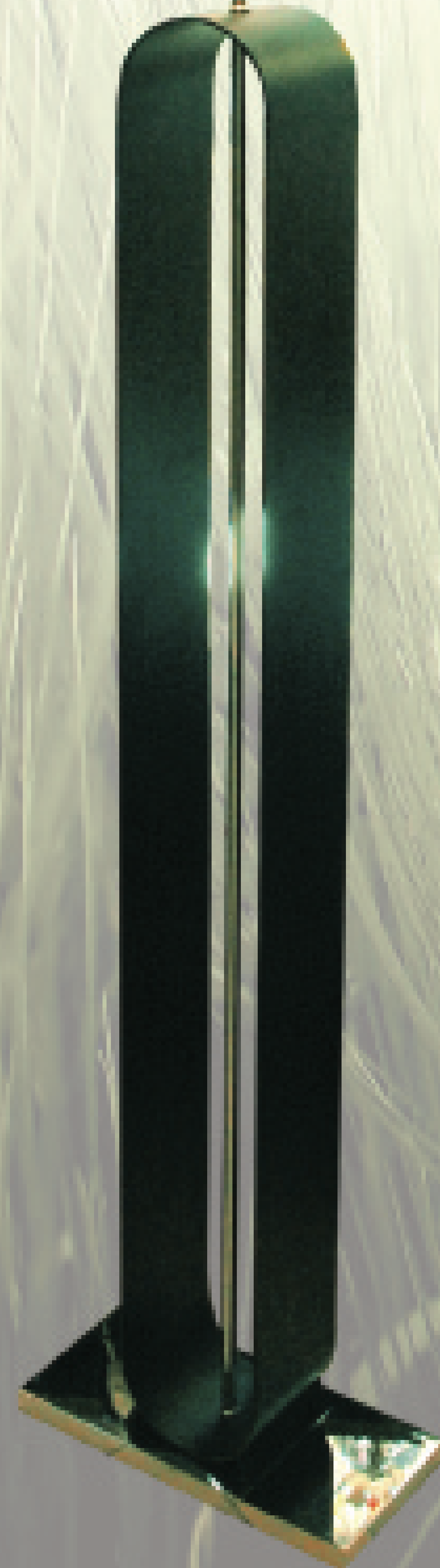



Kod/ Code : M-224
☞☞☞ --- 1x15 w



Kod/ Code : L-131
☞☞☞ --- 1x20 w



Kod/ Code : M-225
☞☞☞ --- 1x15 w



Kod/ Code : M-226
☞☞☞ --- 1x15 w





Kod/ Code : L-132
☞ --- 1x20 w



Kod/ Code : M-227
☞ --- 1x15 w



Kod/ Code : M-228
☞ --- 1x15 w



Kod/ Code : M-229
☞ --- 1x15 w



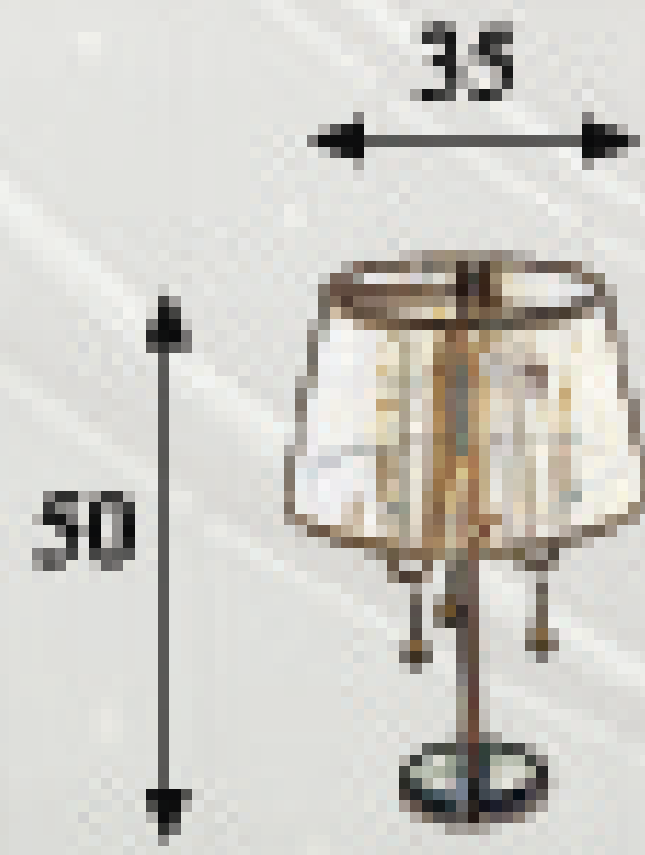

Kod/ Code : M-230
☛ --- 3x11 w



Kod/ Code : M-231
☛ --- 1x15 w

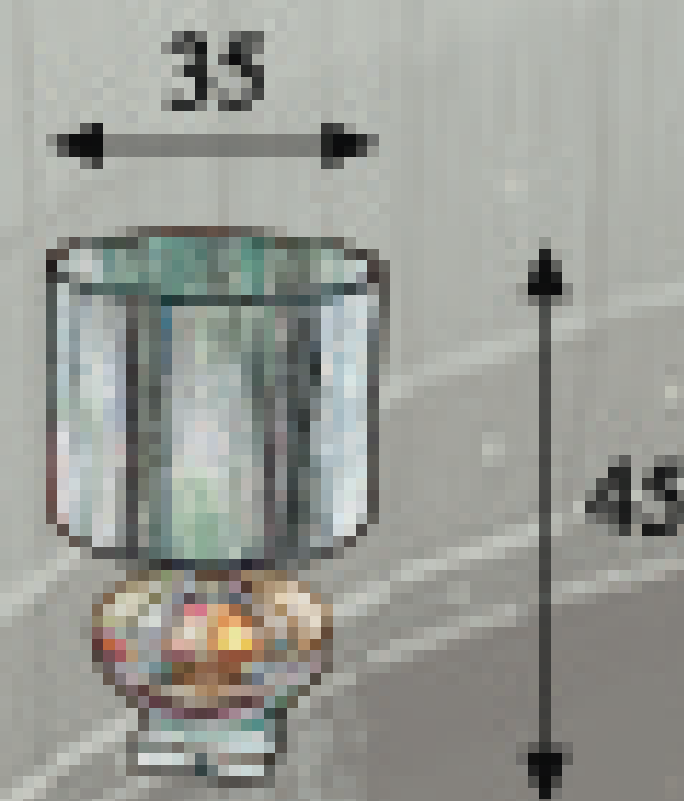

Kod/ Code : M-232
☛ --- 1x15 w

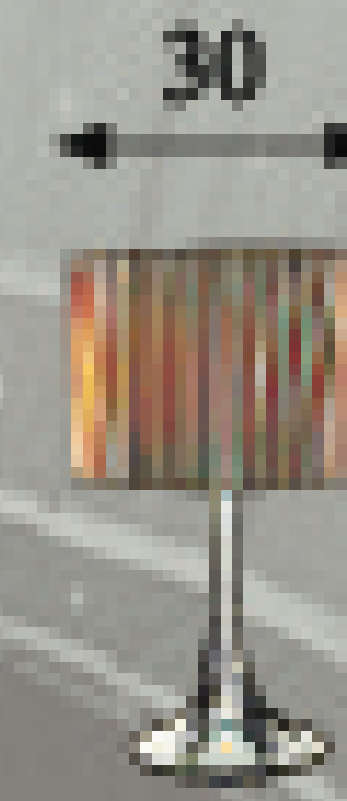

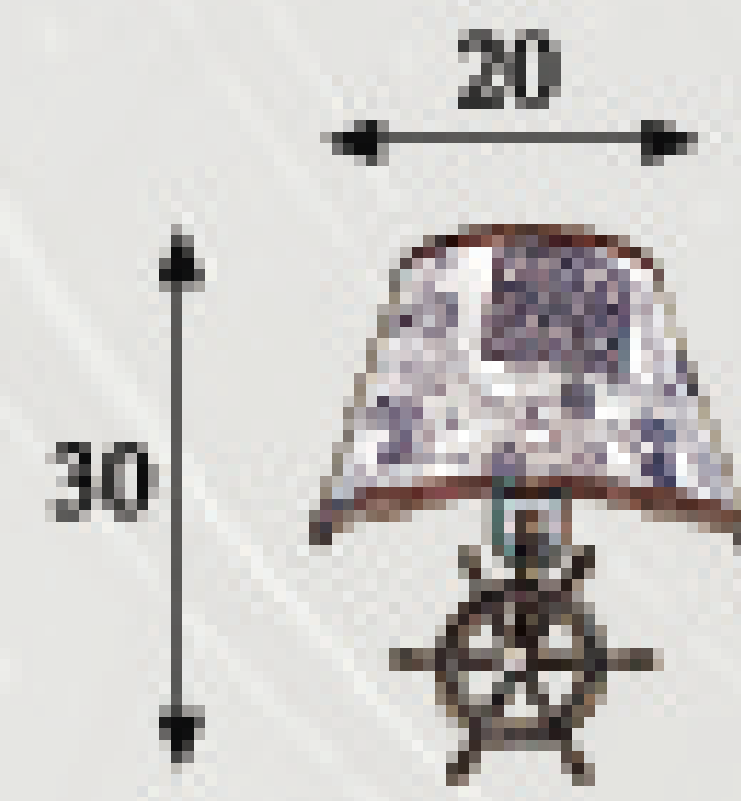

Kod/ Code : A-407
1x15 w



Kod/ Code : M-233
1x15 w



Kod/ Code : M-234
1x15 w









Kod/ Code : T-365
Hj ---- 1x300 w

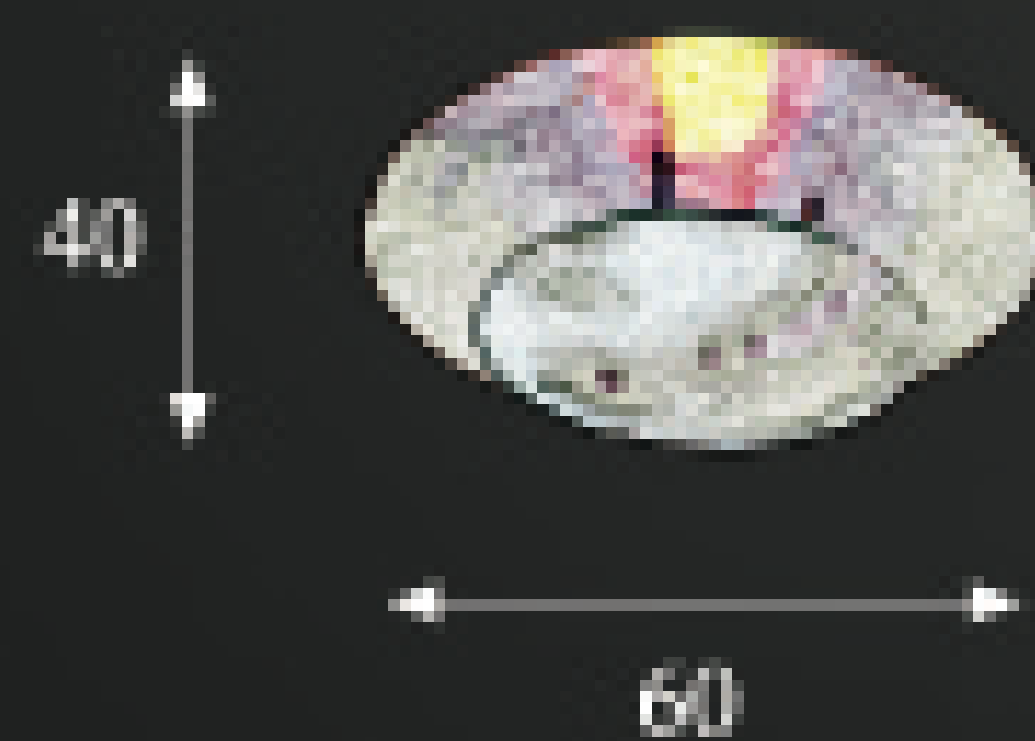

Kod/ Code : A-409
□ □ ---- 1x26 w

Kod/ Code : A-410
□ □ ---- 1x20 w

Kod/ Code : A-411
□ □ ---- 1x20 w





Kod/ Code : A-412
☞ --- 1x26 w

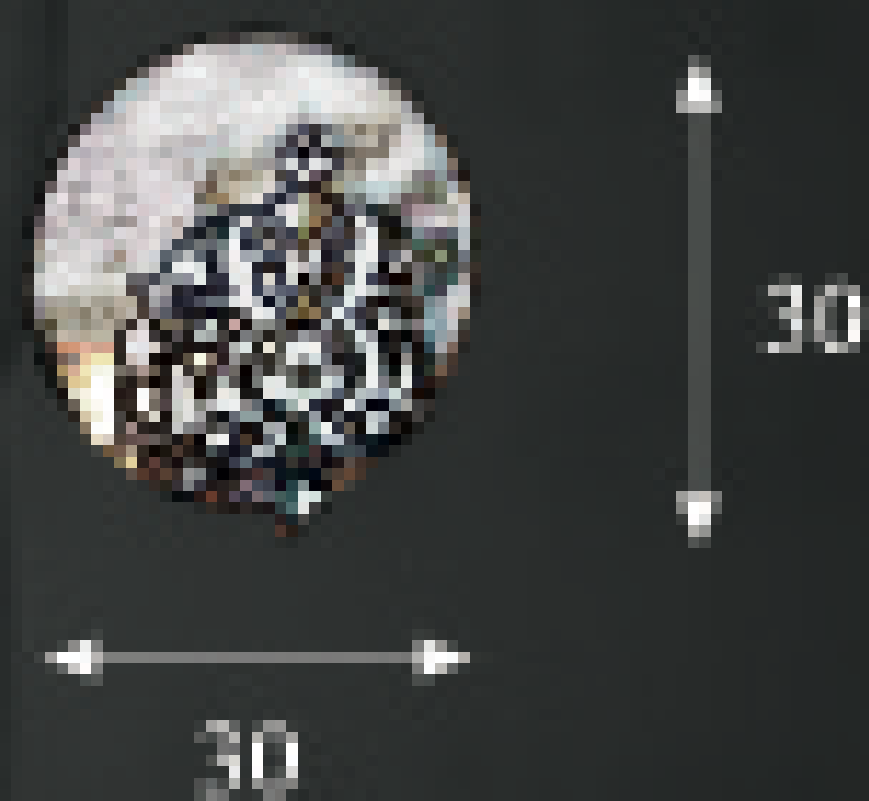

Kod/ Code : A-414
☞ --- 1x26 w

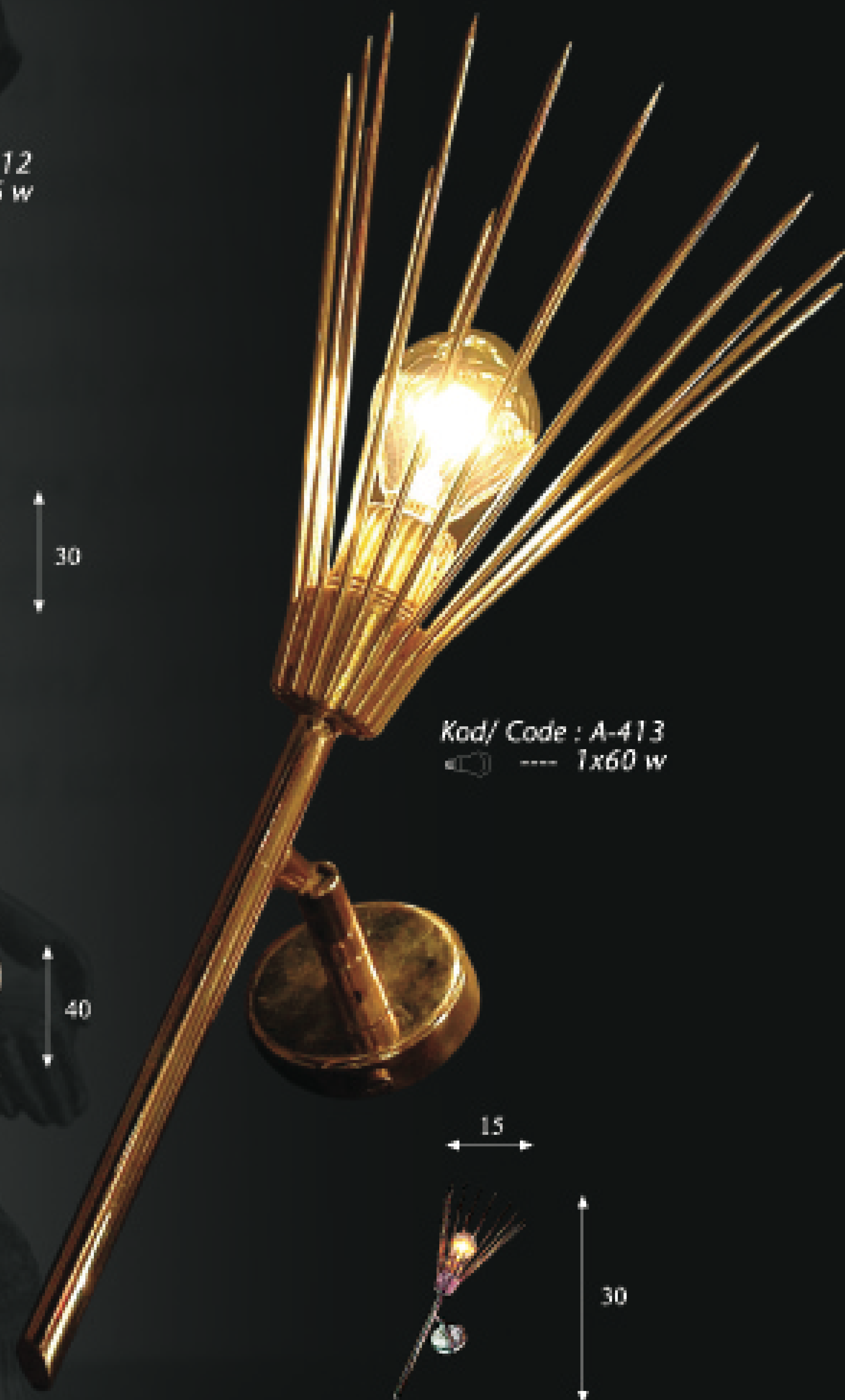

Kod/ Code : A-413
☞ --- 1x60 w

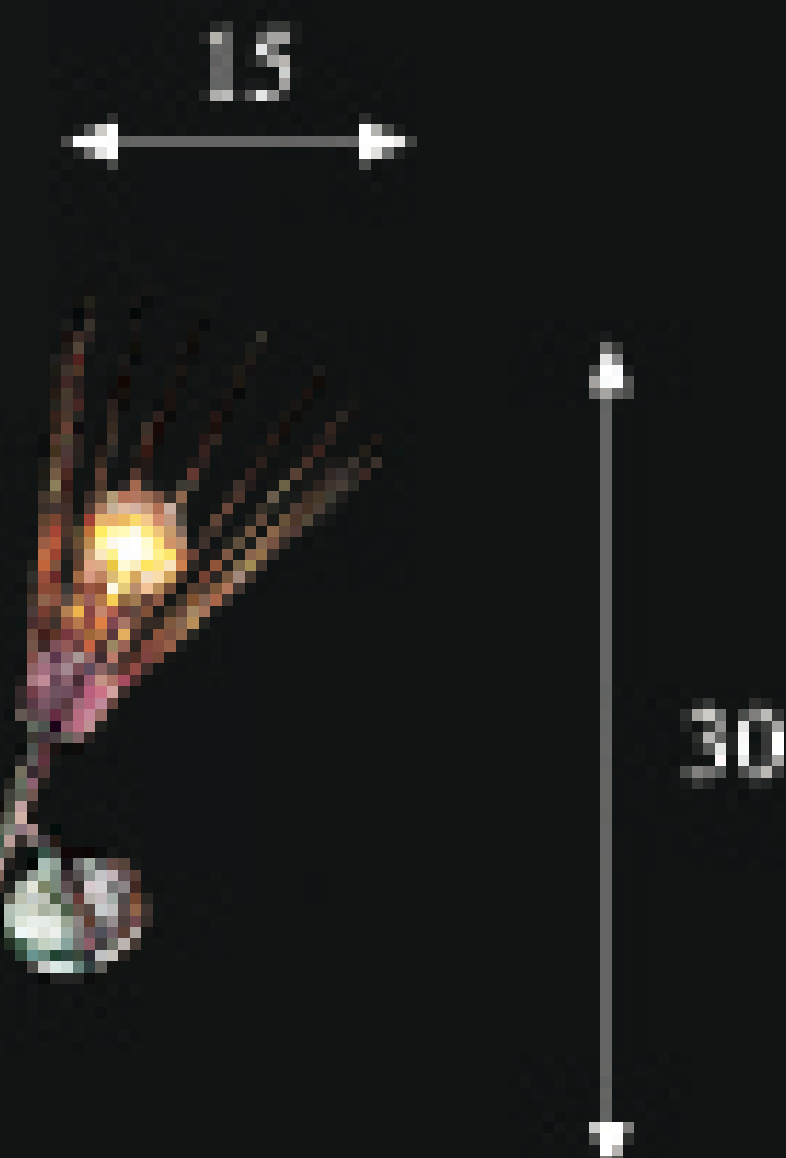



Kod/ Code : A-415
 --- 1x26 w



Kod/ Code : A-416
 --- 1x60 w

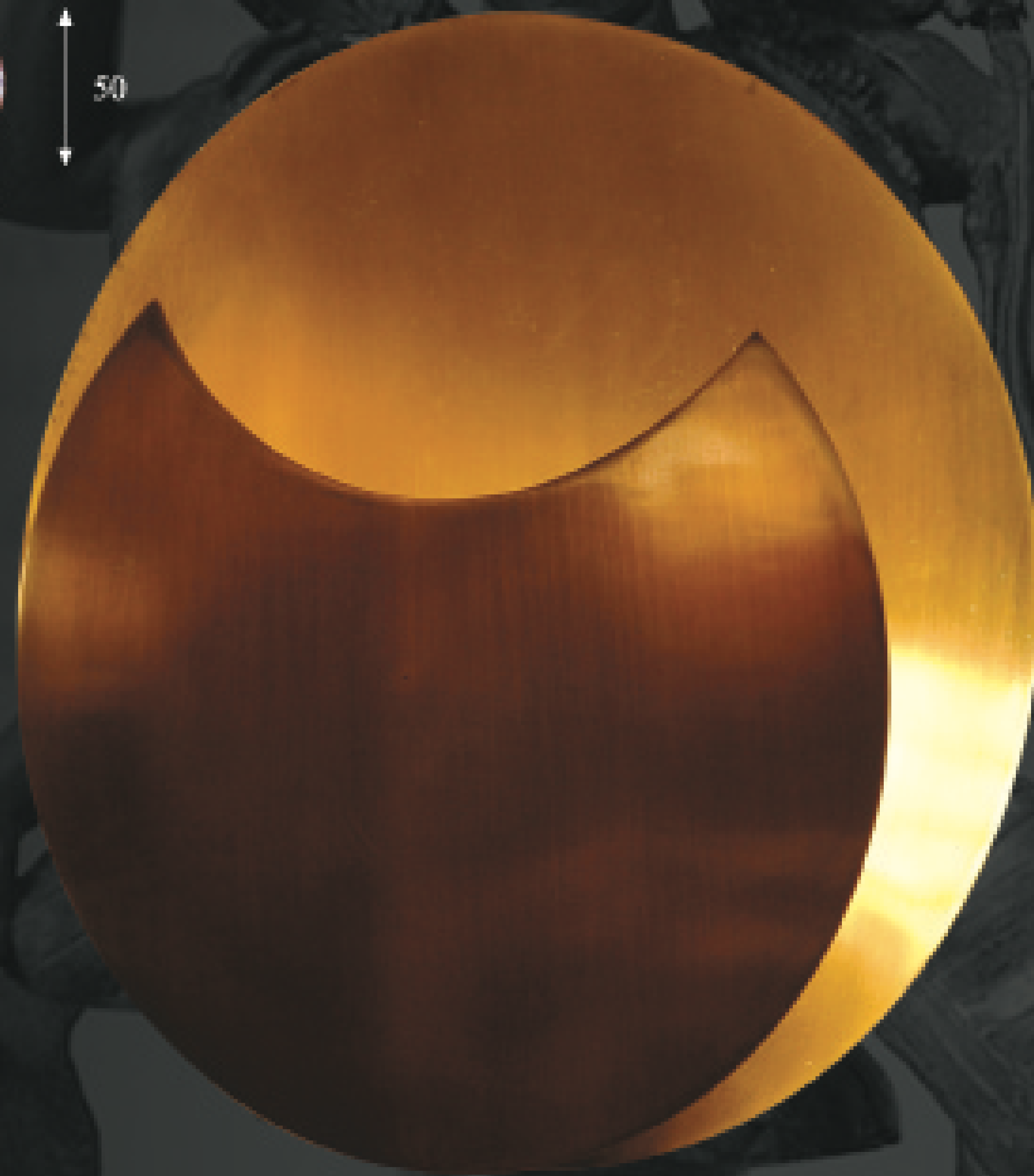
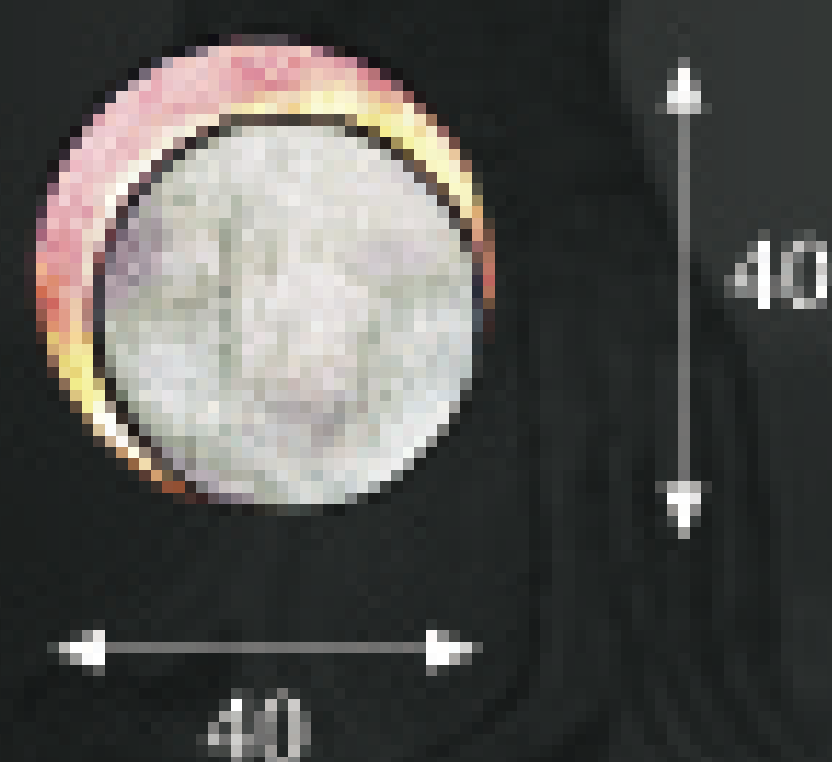

Kod/ Code : A-417
 --- 1x26 w





Kod/ Code : A-418
☞ ☞ --- 1x15 w



Kod/ Code : A-420
☞ ☞ --- 1x15 w



Kod/ Code : A-419
☞ ☞ --- 2x15 w



Kod/ Code : A-421
☞ ☞ --- 2x15 w



Kod/ Code : A-422
☞ ☞ --- 2x15 w





Kod/ Code : A-423
 ☞☞ --- 1x15 w



Kod/ Code : A-424
 ☞☞ --- 1x15 w

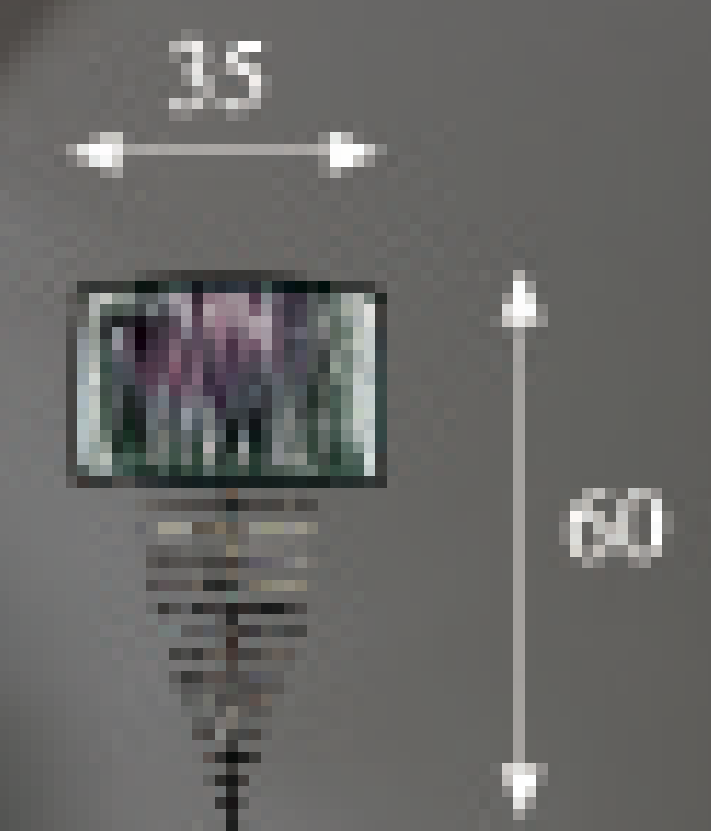

Kod/ Code : A-425
 ☞☞ --- 1x15 w

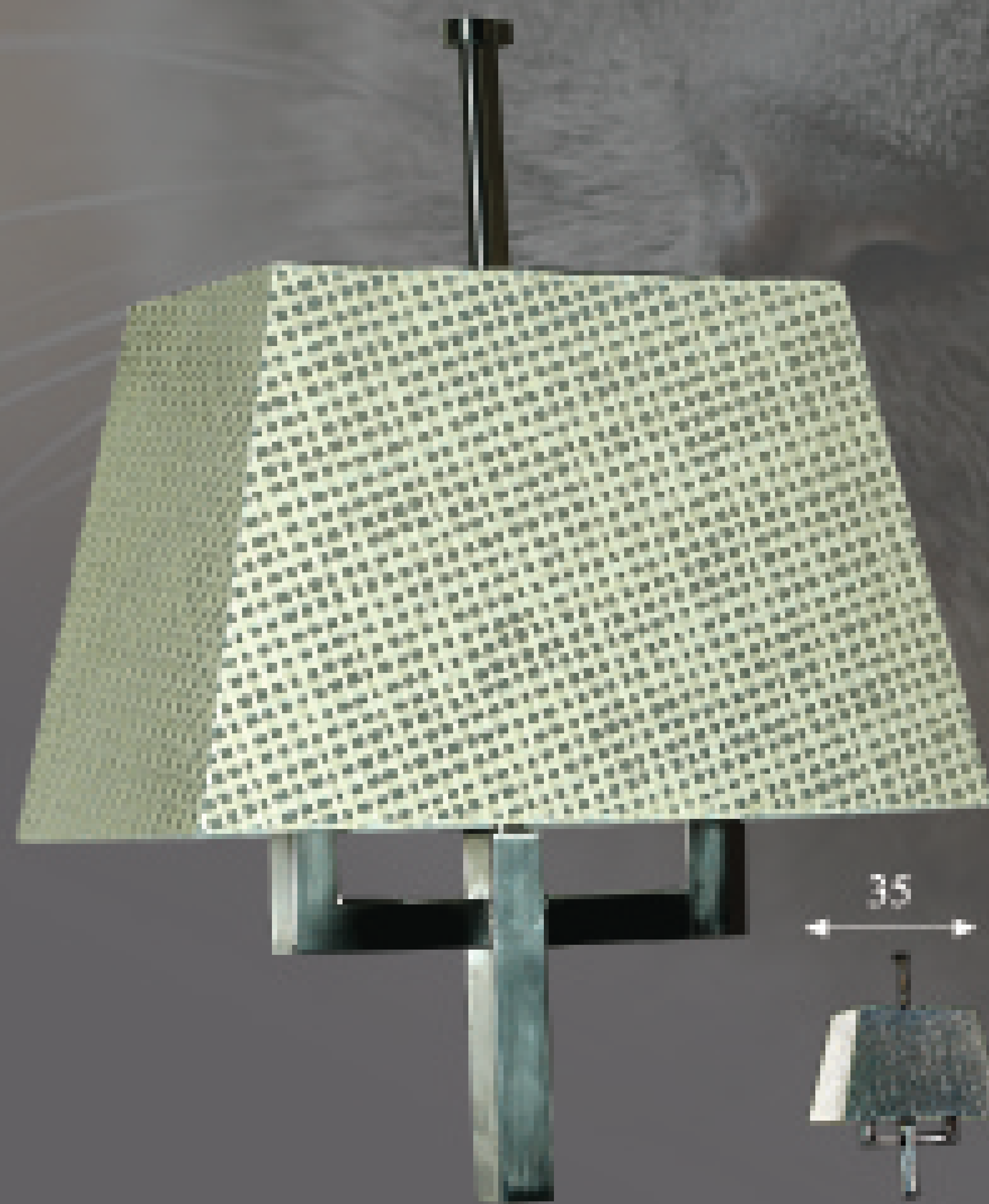

Kod/ Code : A-426
 ☞☞ --- 2x15 w



Kod/ Code : A-427
 ☞☞ --- 1x15 w



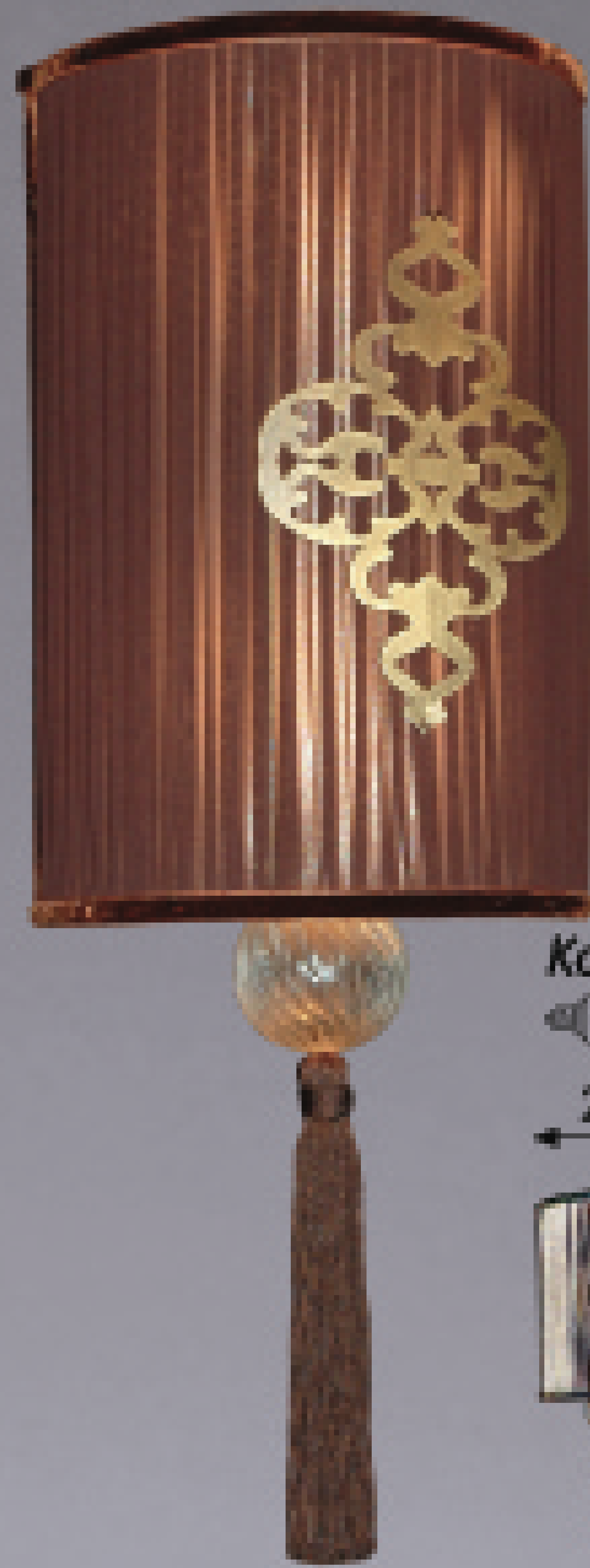

Kod/ Code : A-428
☞ --- 1x15 w

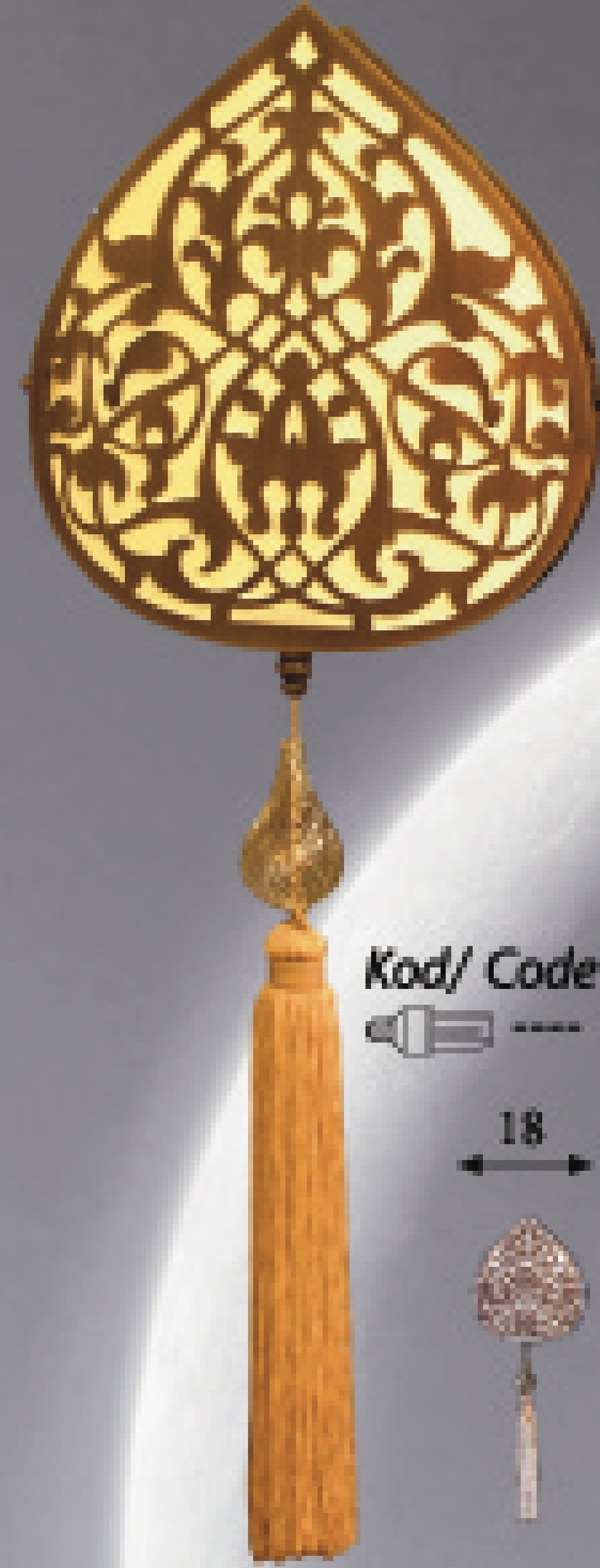

Kod/ Code : A-29
☞ --- 1x15 w



Kod/ Code : A-430
☞ --- 1x15 w



Kod/ Code : A-431
☞ --- 1x15 w



Kod/ Code : A-432
☞ --- 1x15 w



Kod/ Code : A-433
☞ --- 1x15 w





Kod/ Code : A-434
 1x15 w

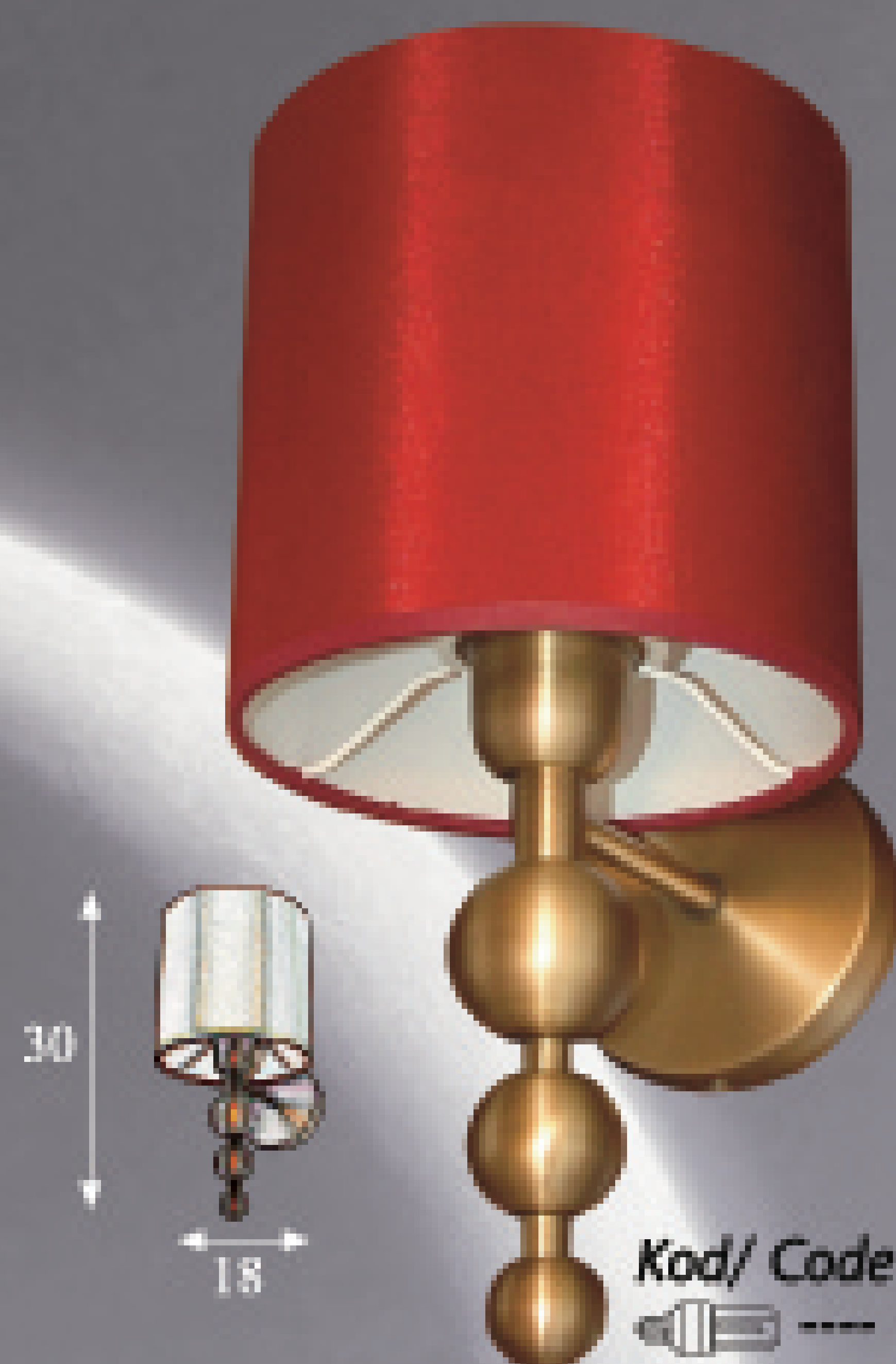

Kod/ Code : A-435
 1x15 w



Kod/ Code : A-436
 1x15 w

Kod/ Code : A-437
 1x15 w

Kod/ Code : A-438
 1x15 w

Kod/ Code : A-439
 1x15 w





Kod/ Code : A-440
☞ --- 1x15 w

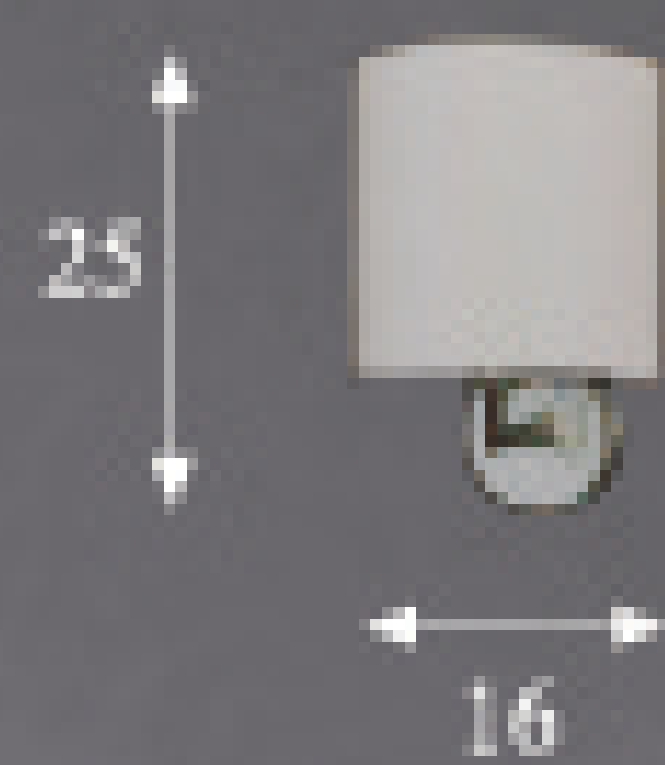

Kod/ Code : A-441
☞ --- 1x15 w



Kod/ Code : A-442
☞ --- 1x15 w



Kod/ Code : A-443
☞ --- 1x15 w



Kod/ Code : A-444
☞ --- 1x15 w



Kod/ Code : A-445
 ⚡ --- 1x15 w



Kod/ Code : A-446
 ⚡ --- 1x15 w



Kod/ Code : A-447
 ⚡ --- 1x15 w



Kod/ Code : A-448
 ⚡ --- 1x15 w



Kod/ Code : A-449
 ⚡ --- 1x15 w



Kod/ Code : A-450
 ⚡ --- 1x15 w

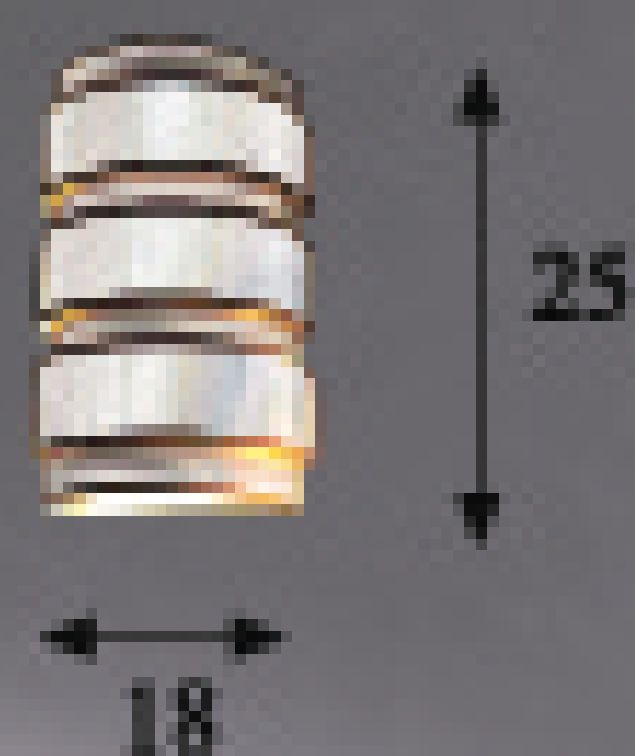
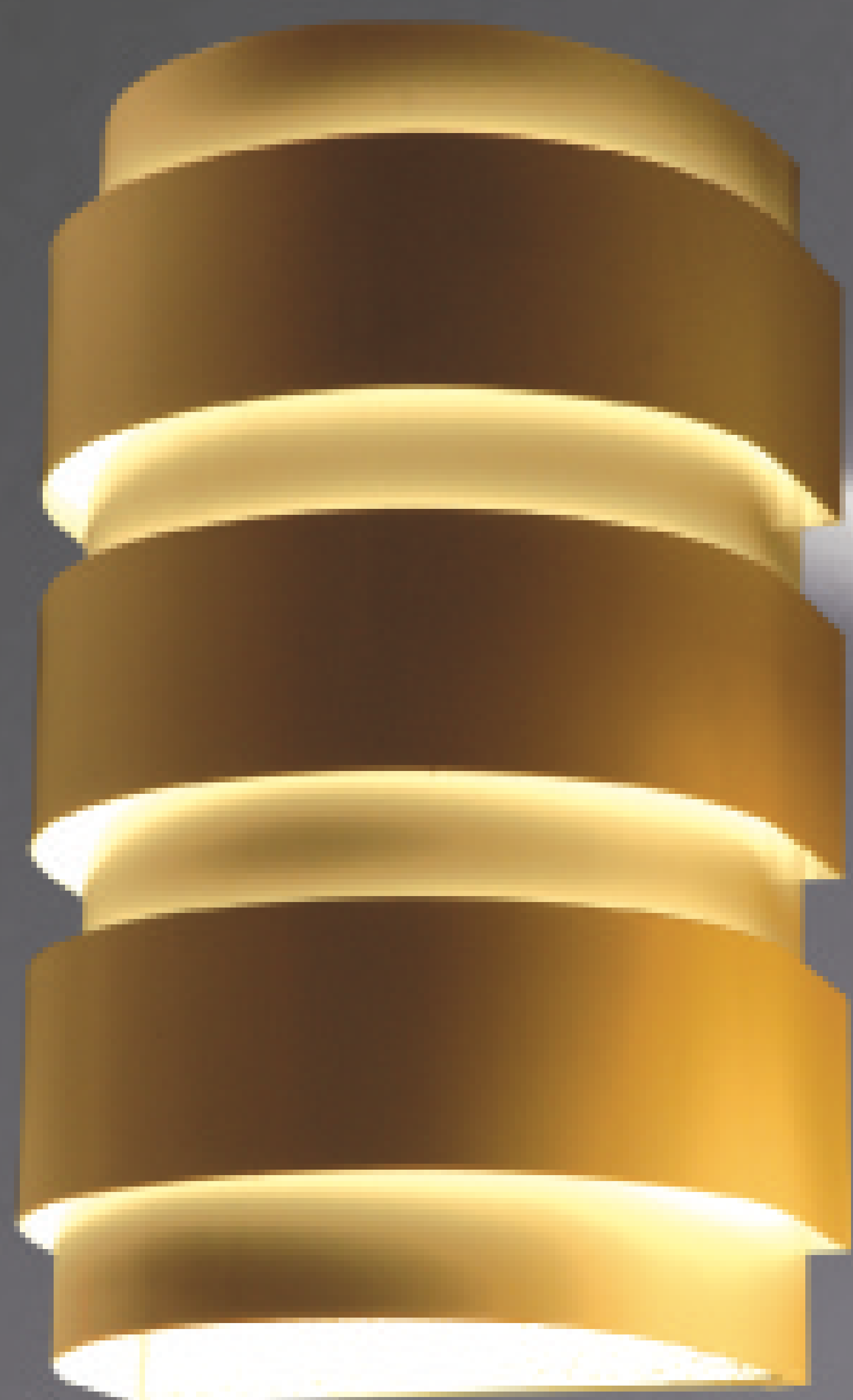

Kod/ Code : A-451
☞ --- 1x15 w



Kod/ Code : A-452
☞ --- 1x15 w

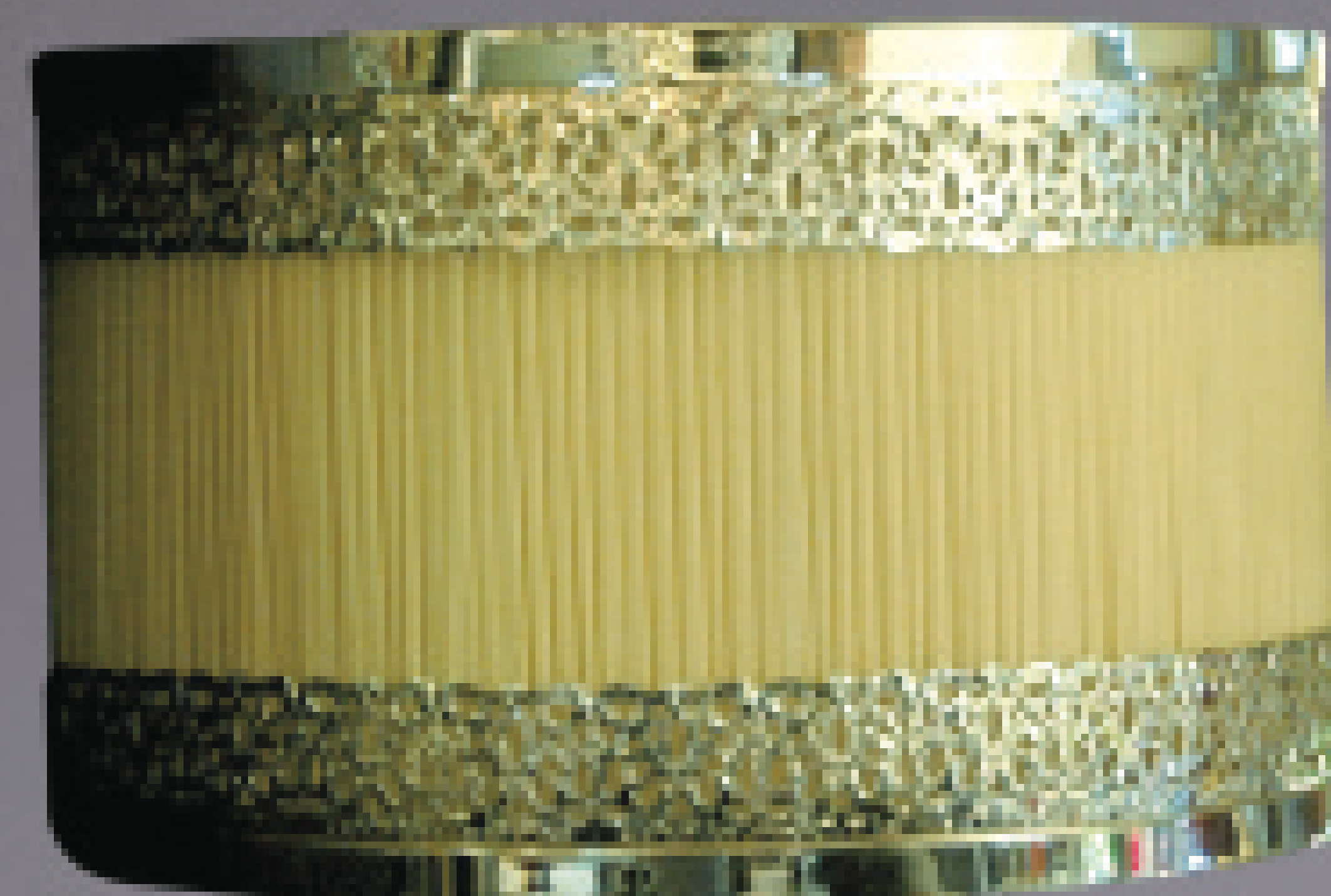



Kod/ Code : A-453
☞ --- 2x15 w



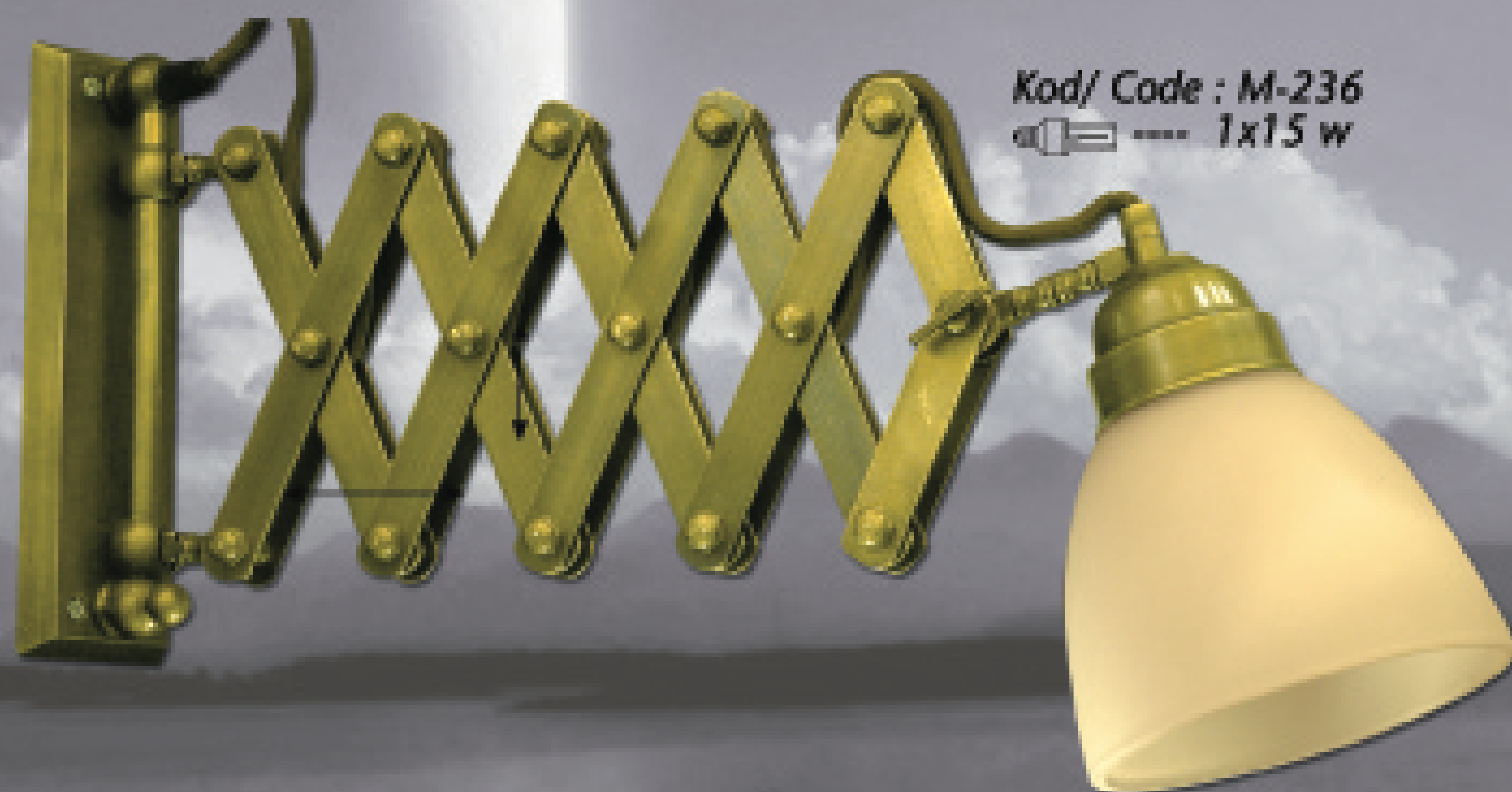

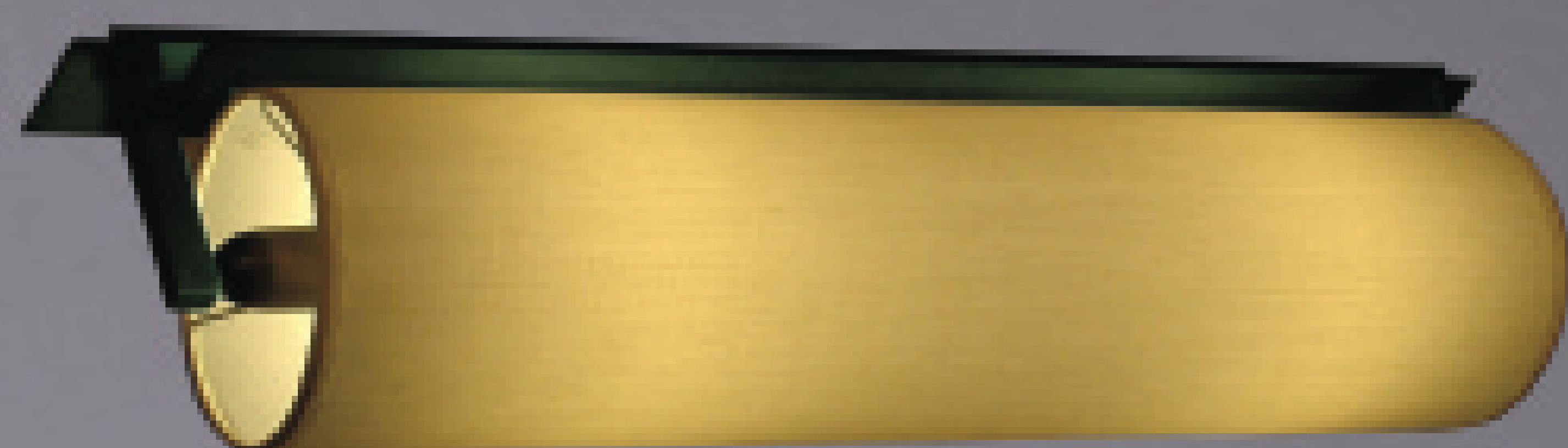
Kod/ Code : M-236
☞ --- 1x15 w



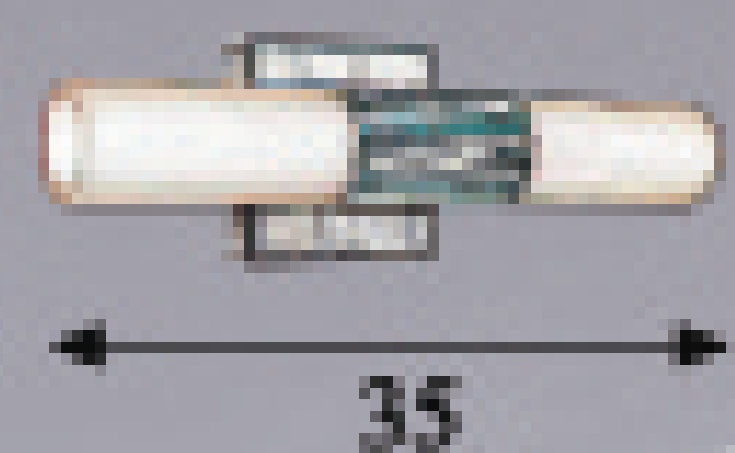
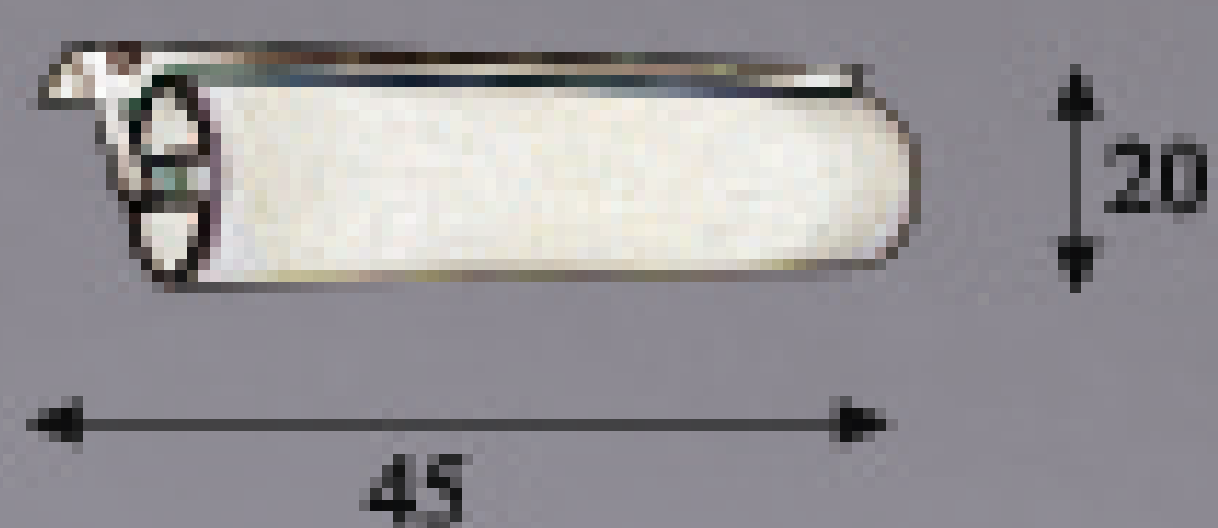

Kod/ Code : A-454
 2x11 w



Kod/ Code : A-455
 2x11 w

Kod/ Code : A-456
 1x9 w

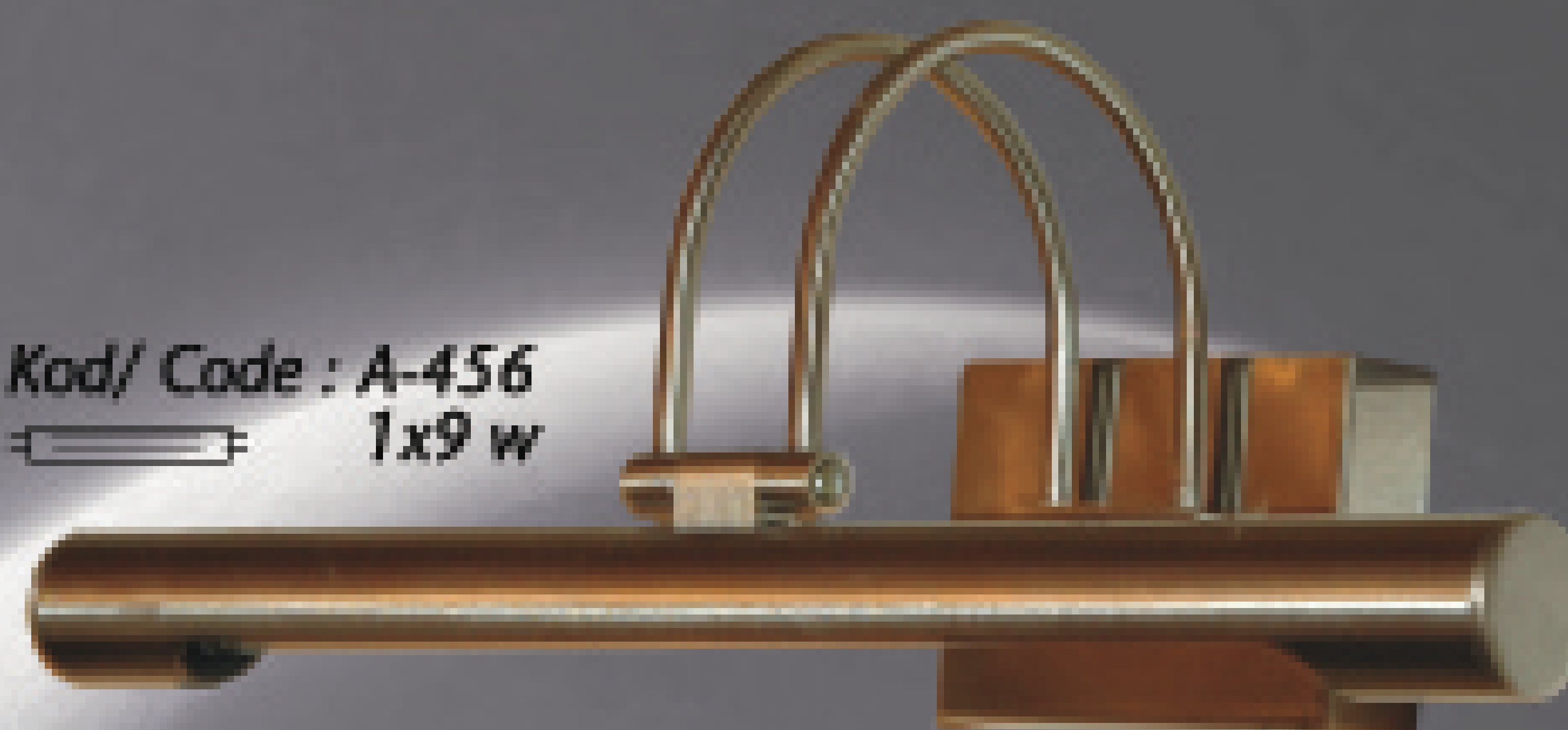

Kod/ Code : A-457
 1x13 w

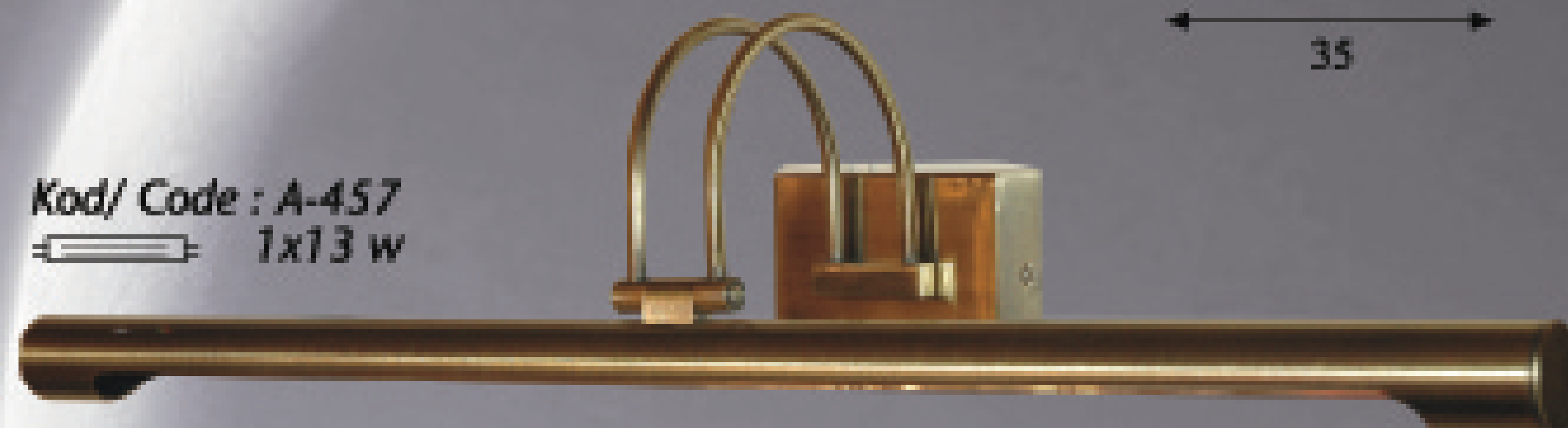

Kod/ Code : A-458
 1x18 w

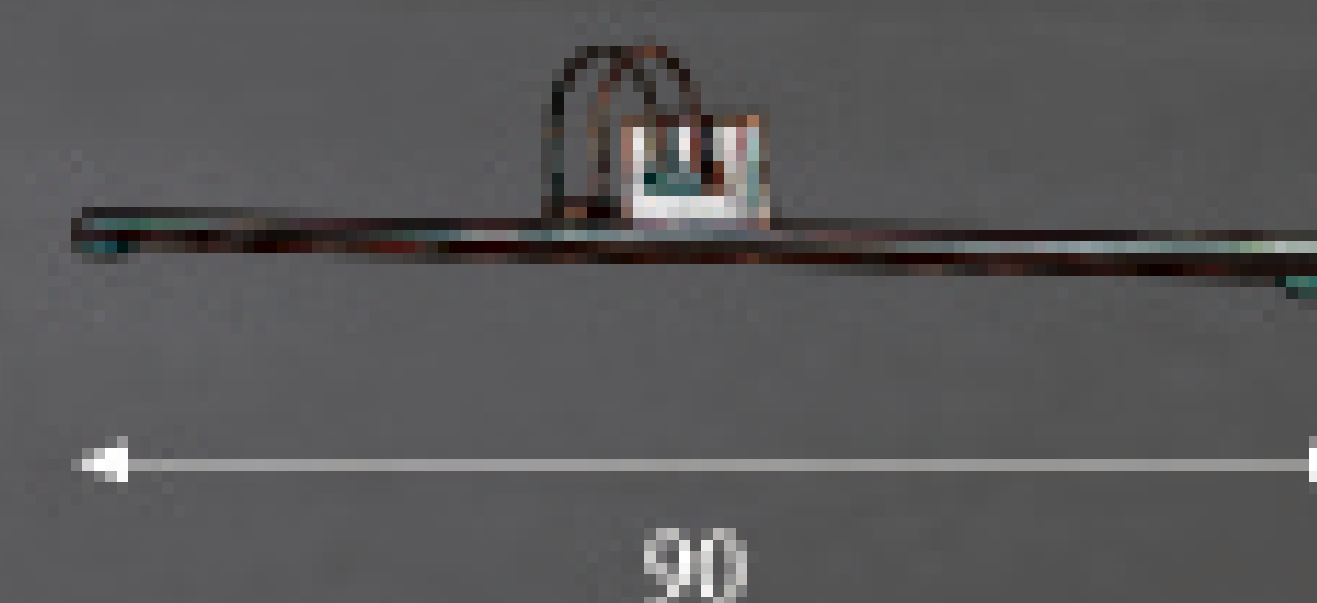

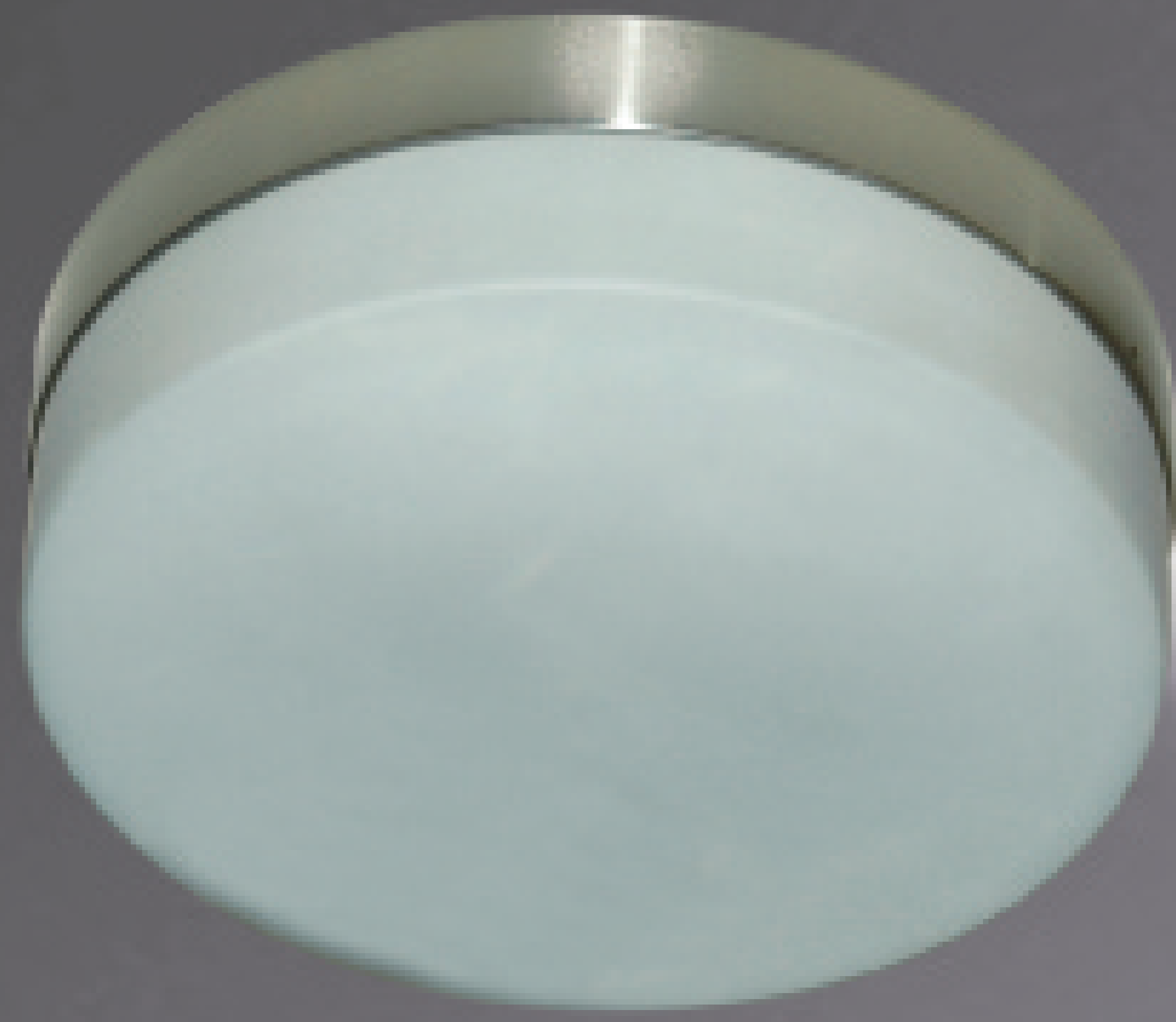

Kod/ Code : A-459
☞☞☞☞ 2x11 w



Kod/ Code : A-460
☞☞☞☞ 2x11 w



Kod/ Code : A-461
☞☞☞☞ 2x11 w

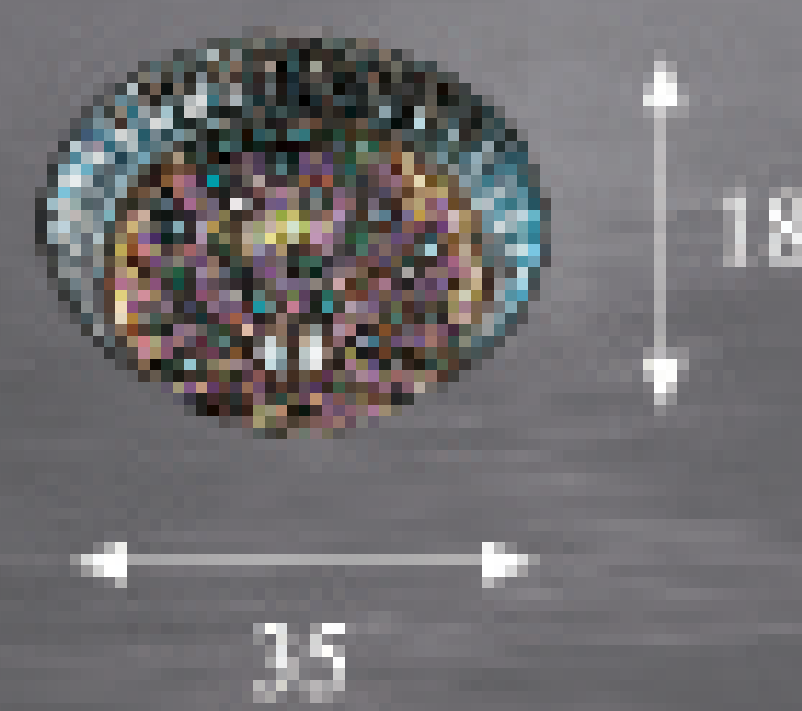



Kod/ Code : L-133
☞☞ ----- 1x18w

Kod/ Code : M-237
☞☞ ----- 1x15w

Kod/ Code : M-238
☞☞ ----- 1x15w





Kod/ Code : L-134
☞ ----- 1x20w

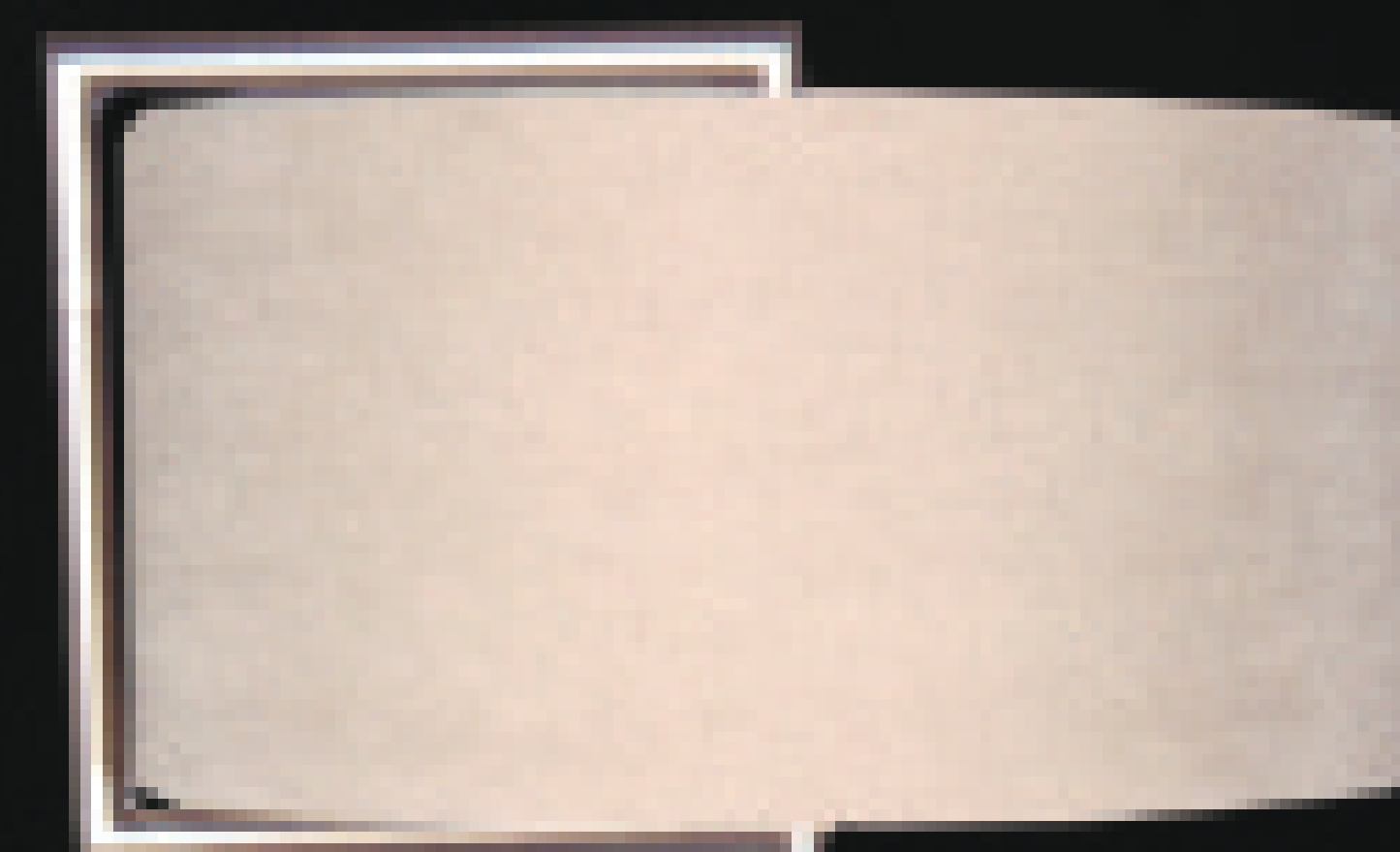

Kod/ Code : L-135
☞ ----- 3x11w



Kod/ Code : M-239
☞ ----- 1x15w

40



170

37



60

65

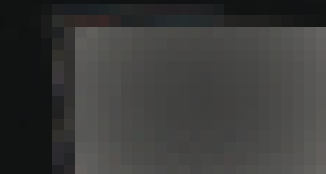

170



Kod/ Code : A-462
☞☞☞ ☞☞☞ 1x15w

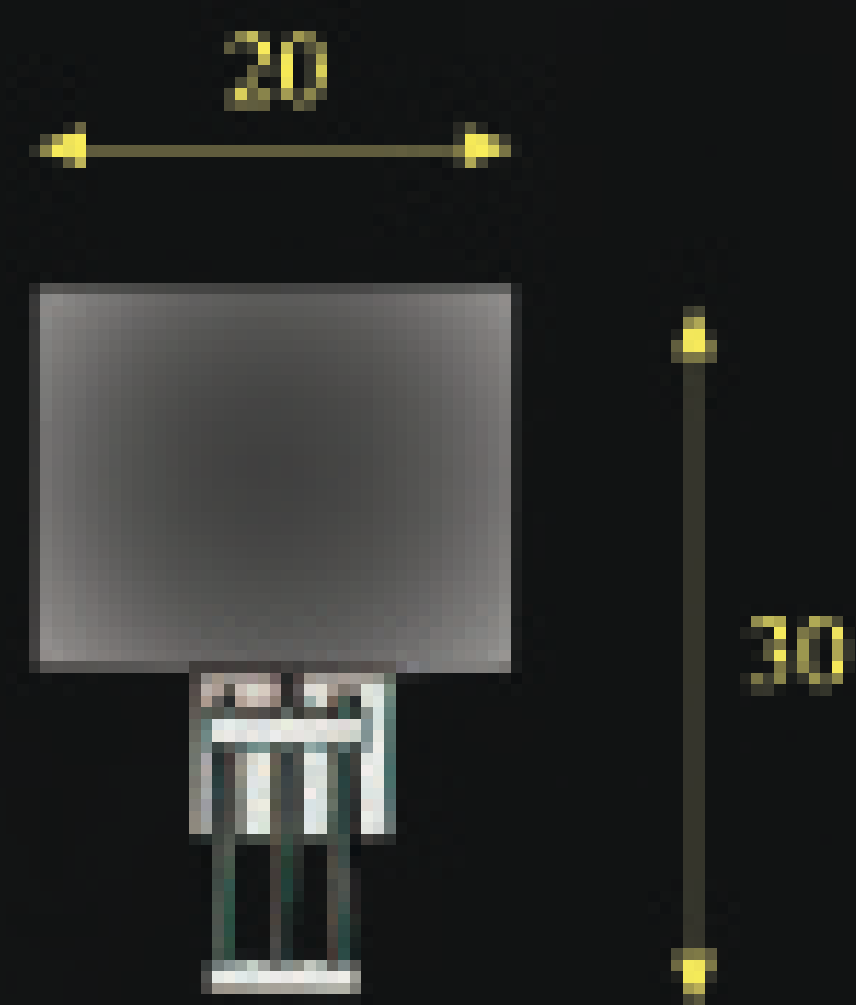
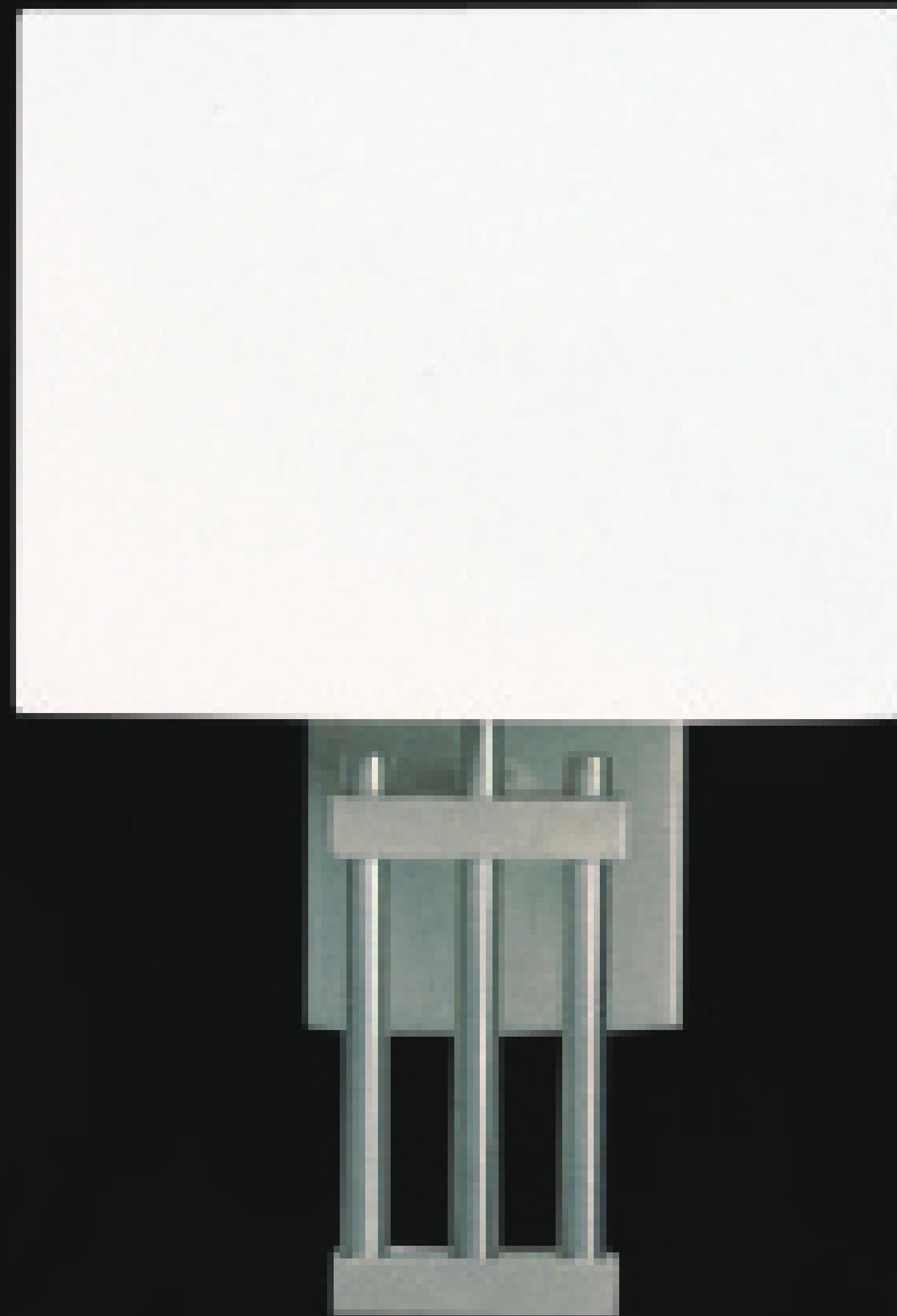

Kod/ Code : L-136
☞☞☞ ☞☞☞ 1x20w

Kod/ Code : M-240
☞☞☞ ☞☞☞ 1x15w

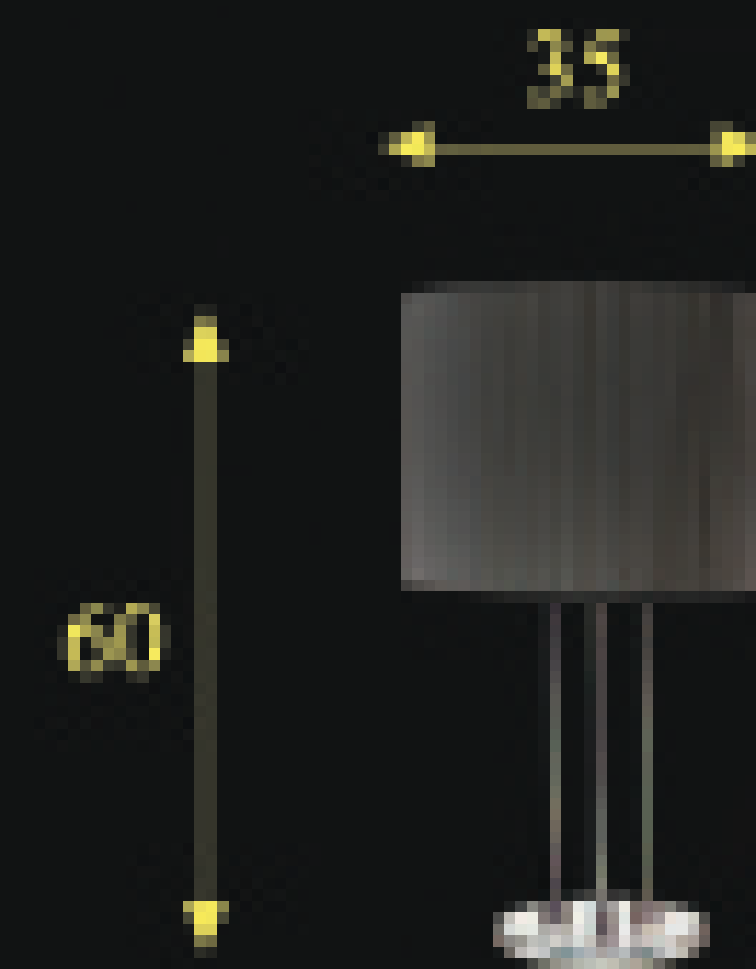
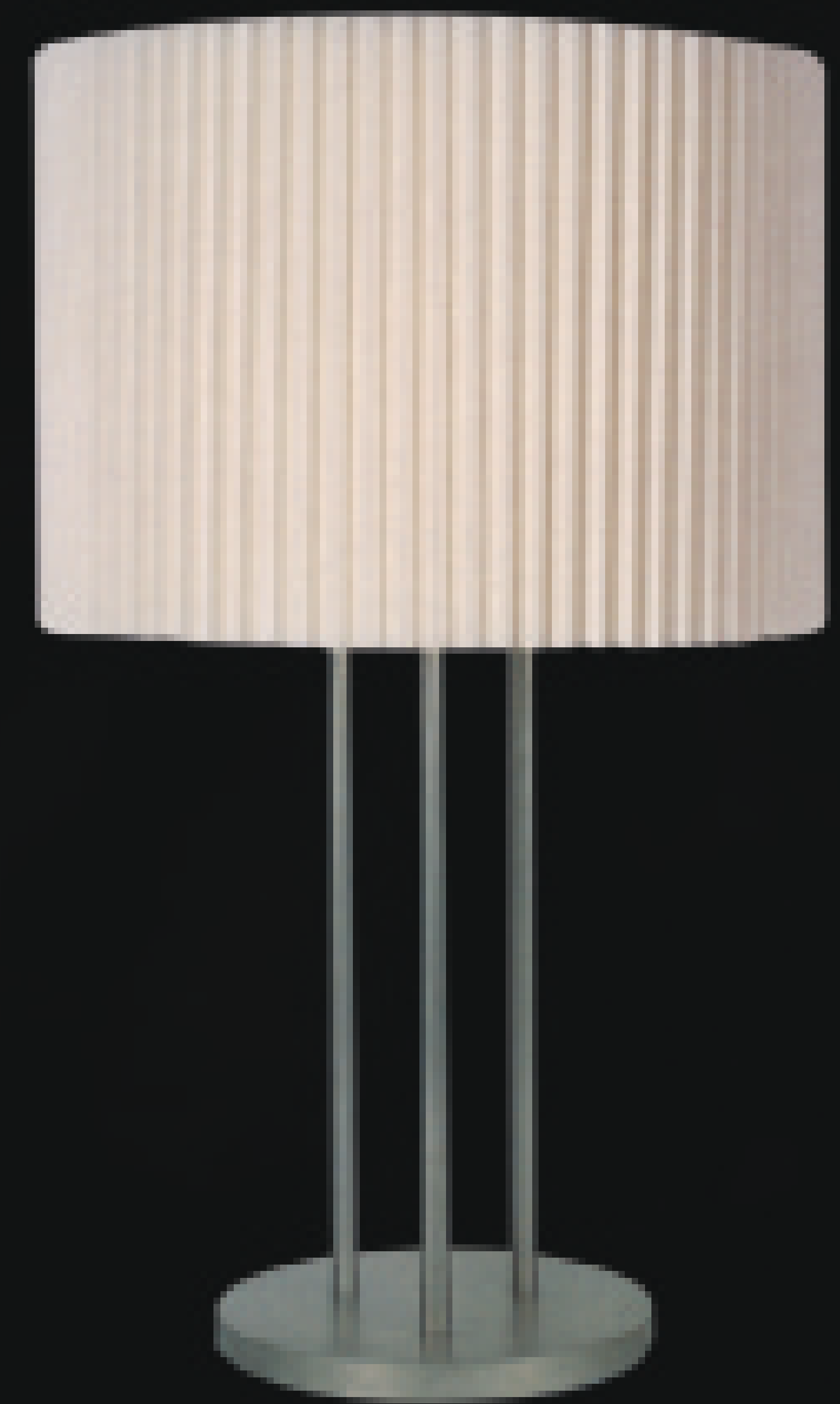

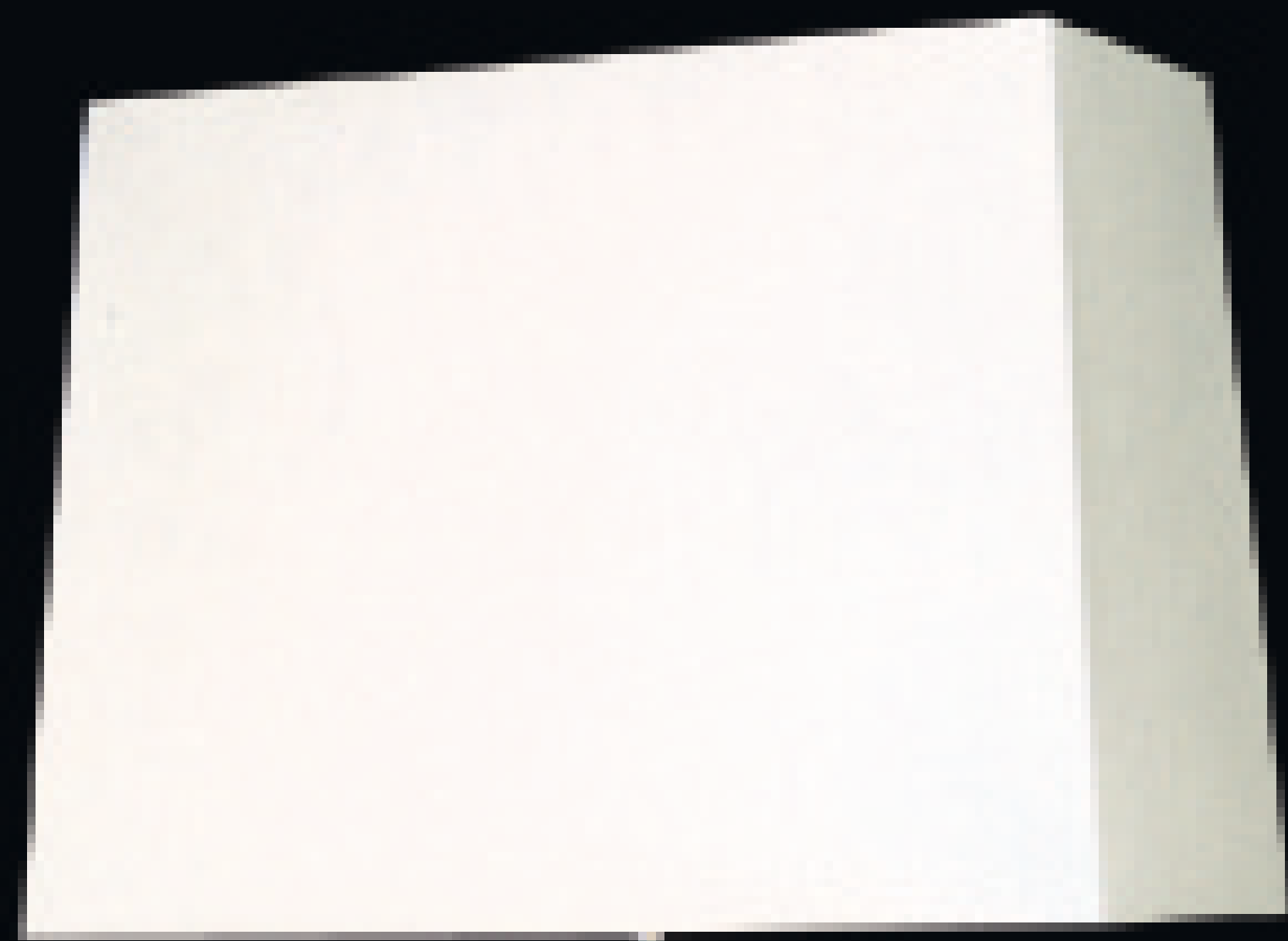

Kod/ Code : L-137
☞☞☞ ☞☞☞ 1x20w

Kod/ Code : L-138
☞☞☞ ☞☞☞ 1x20w

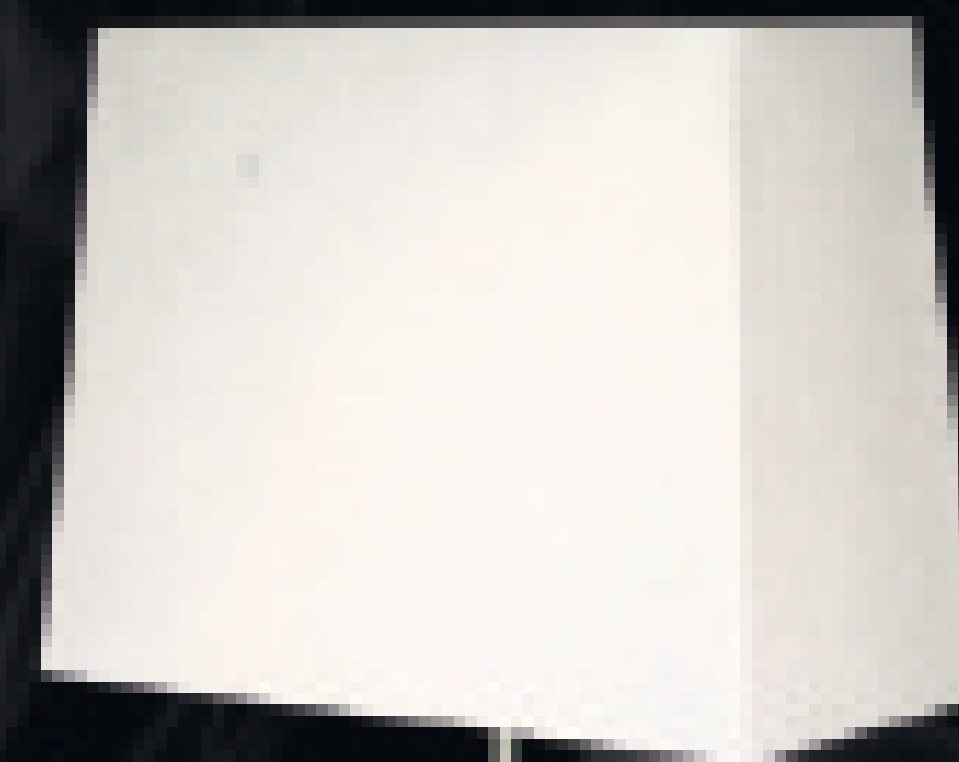
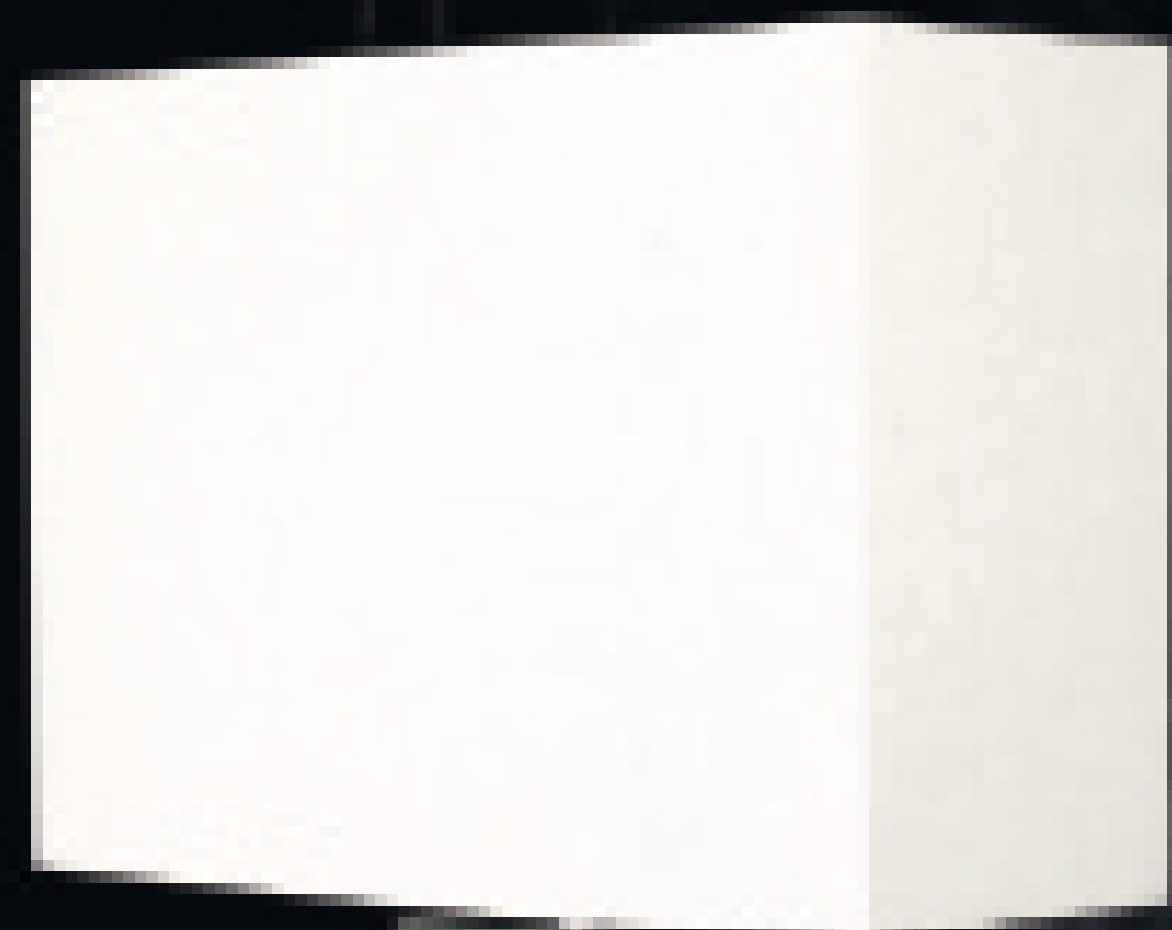
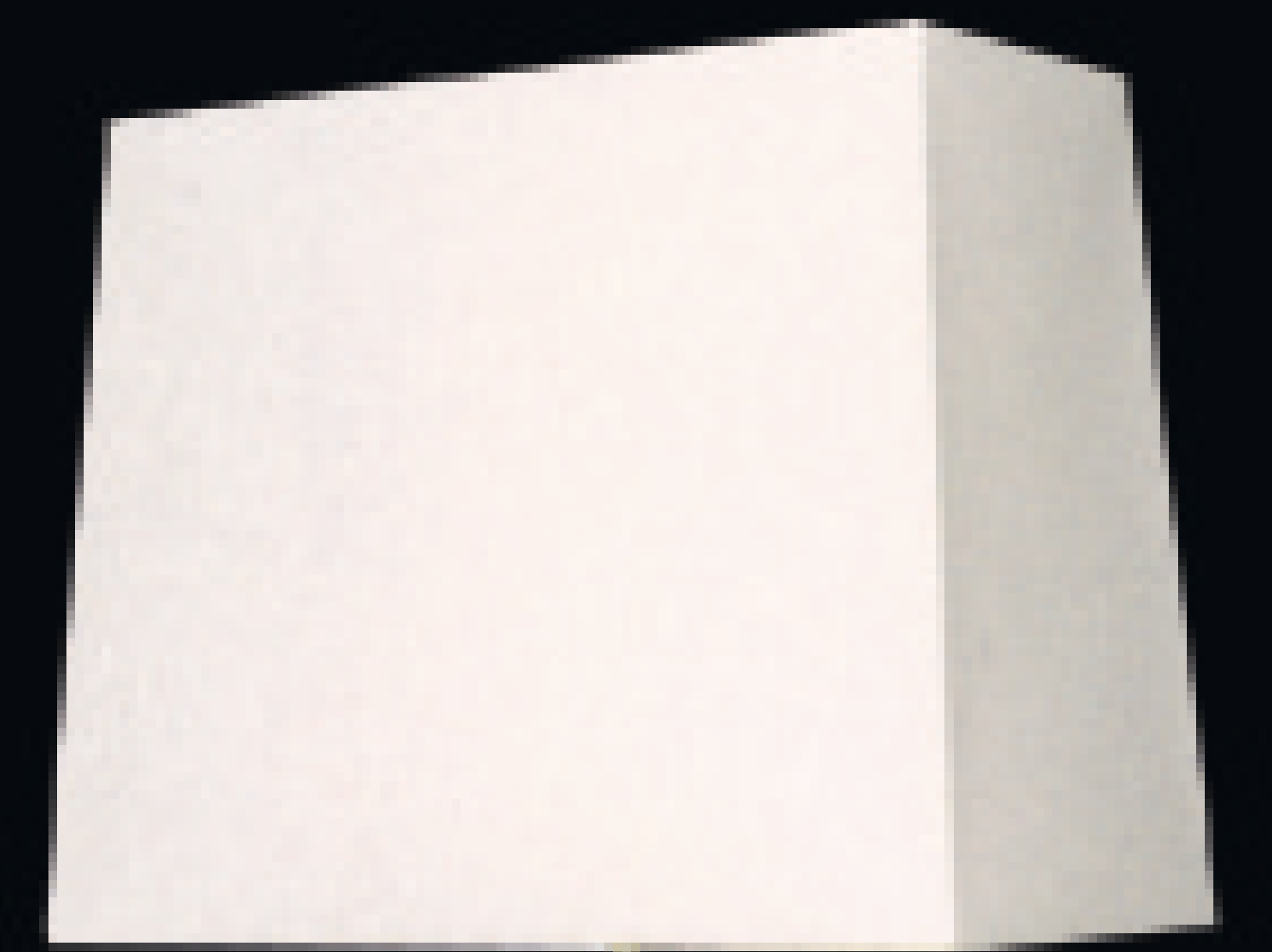

Kod/ Code : M-241
☞☞☞ ☞☞☞ 1x15w

Kod/ Code : M-242
☞☞☞ ☞☞☞ 1x15w

45

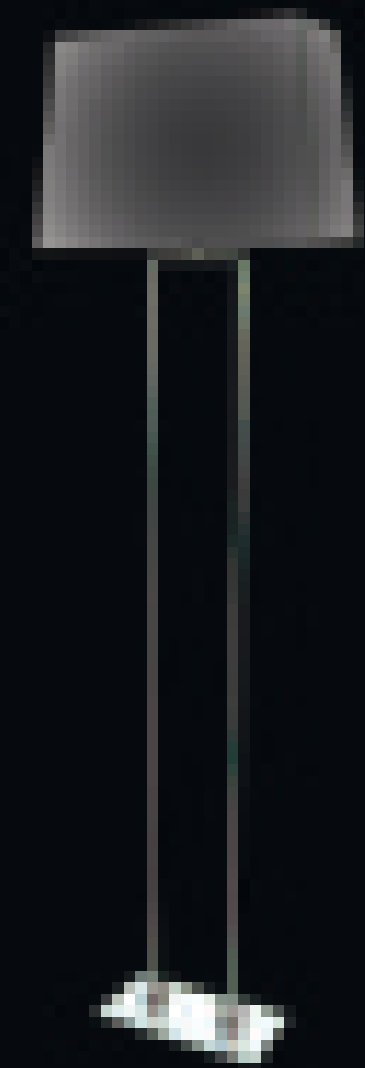

165

50

35



35



60

160

40







Kod/ Code : A-463
☞☞☞ ----- 1x15w



Kod/ Code : L-141
☞☞☞ ----- 1x20w



Kod/ Code : M-245
☞☞☞ ----- 1x15w



Kod/ Code : A-464
☞☞☞ ----- 1x15w

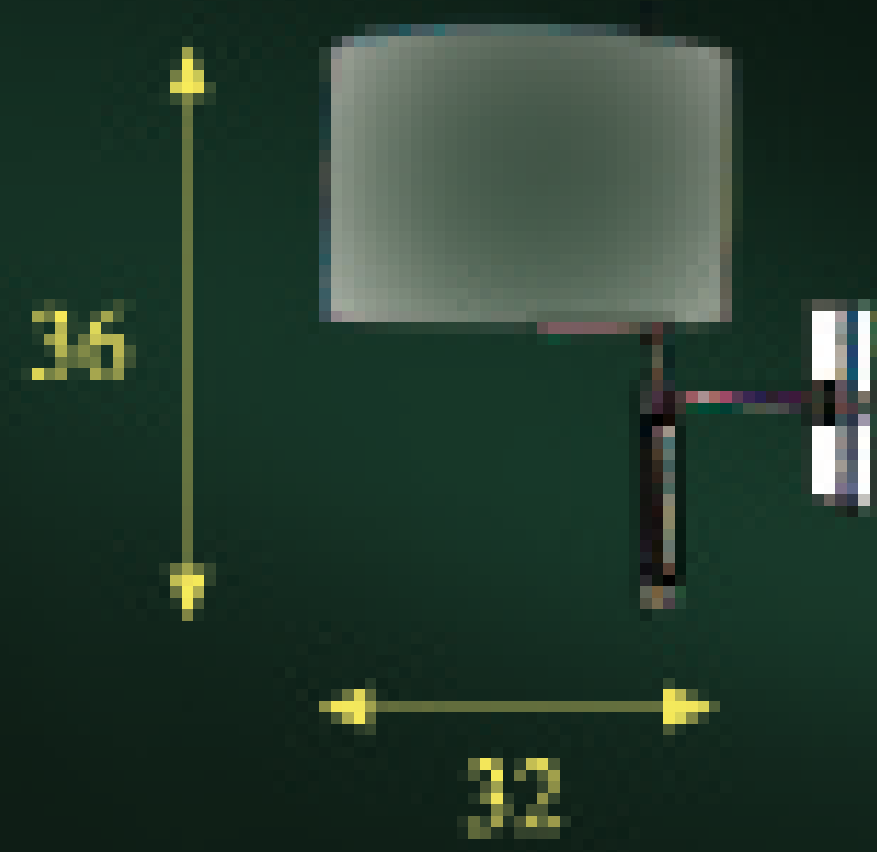



Kod/ Code : L-142
☞☞☞☞☞ 1x20w





Kod/ Code : T-366
☞☞☞ ----- 3x15w



Kod/ Code : A-367
☞☞ ----- 2x15w

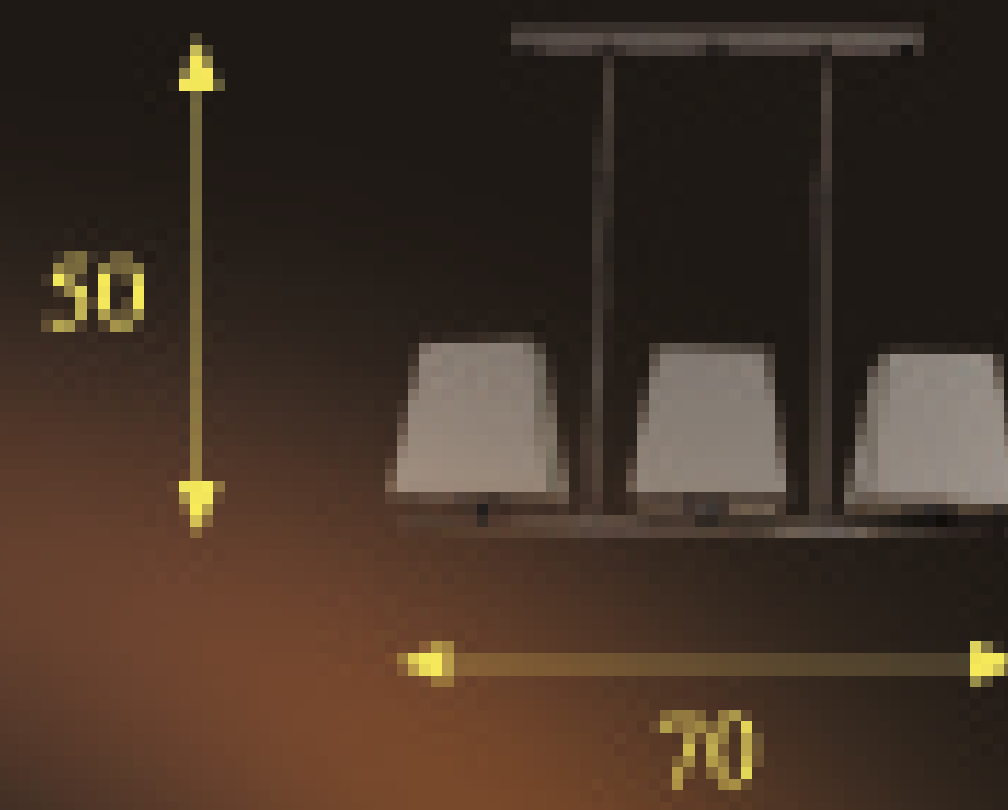

Kod/ Code : M-248
☞☞ ----- 1x15w



Kod/ Code : M-249
☞☞ ----- 1x15w

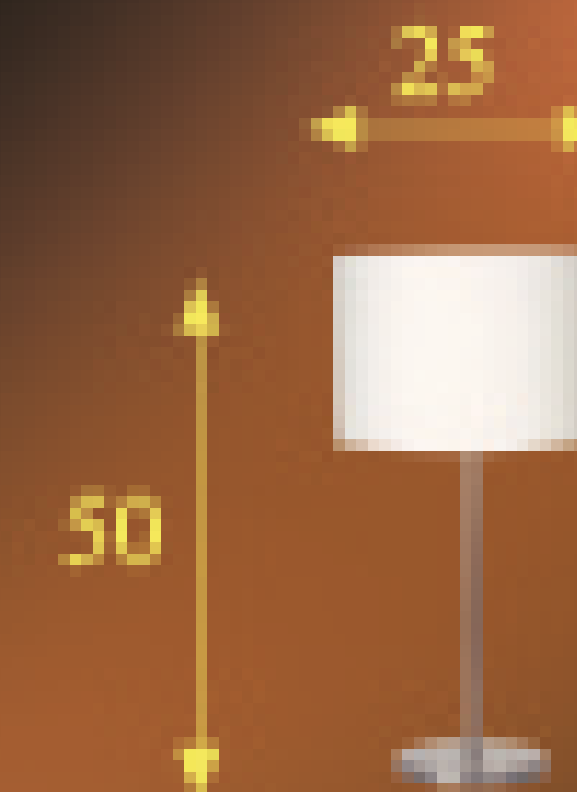



Kod/ Code : A-466
☞☞ ☐ ----- 1x15w



Kod/ Code : L-143
☞☞ ☐ ----- 1x20w



Kod/ Code : M-250
☞☞ ☐ ----- 1x15w



Kod/ Code : M-251
☞☞ ☐ ----- 1x15w





Kod/ Code : L-144
☑ ☑ ----- 1x20w



Kod/ Code : A-467
☑ ☑ ----- 1x15w



Kod/ Code : A-468
☑ ☑ ----- 1x15w

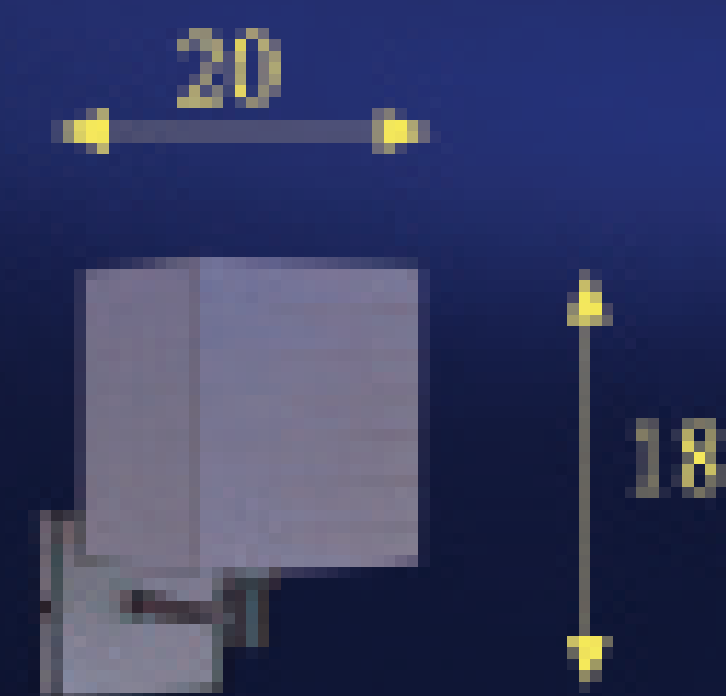

Kod/ Code : M-252
☑ ☑ ----- 1x15w

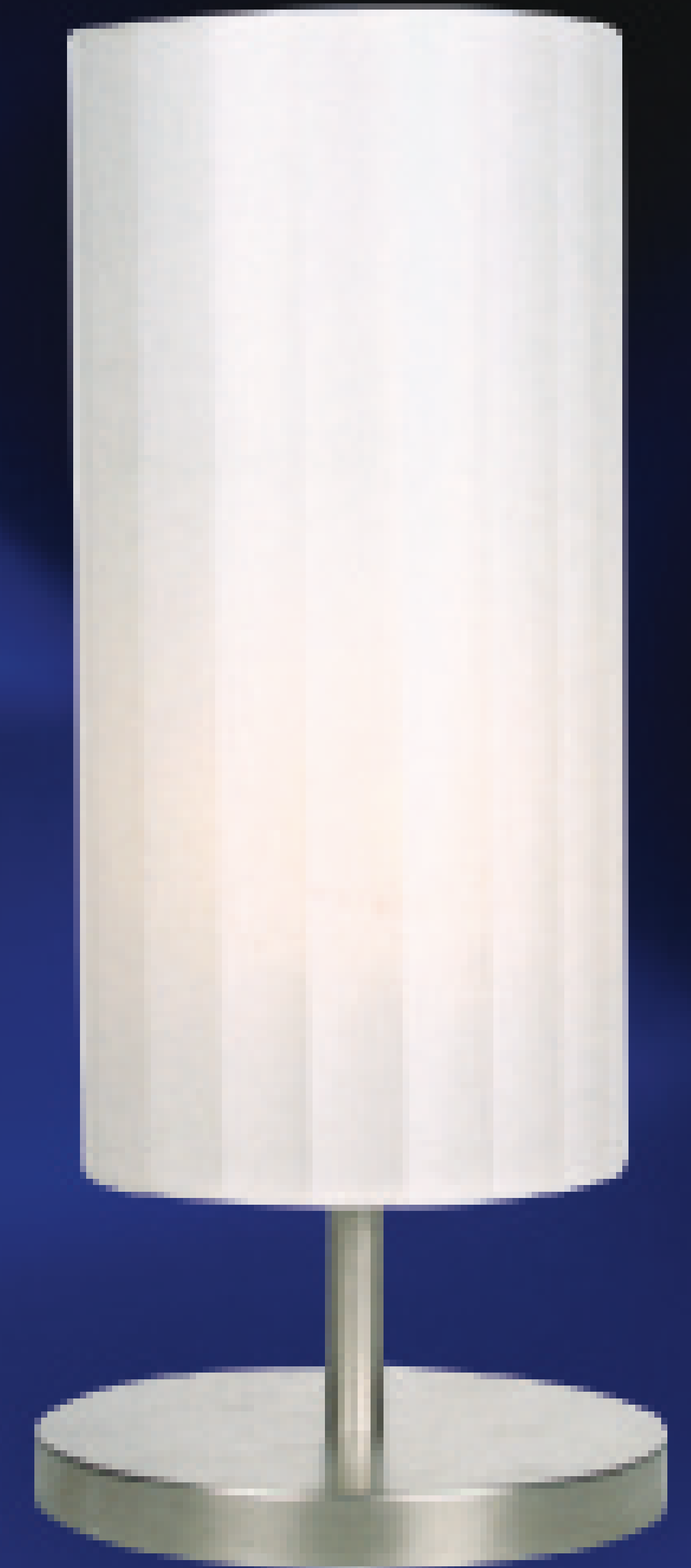



Kod/ Code : A-469
☞☞ ----- 2x15w



Kod/ Code : L-145
☞☞ ----- 1x20w



Kod/ Code : A-470
☞☞☞ ----- 3x15w





Kod/ Code : A-471
☞☞☞ ----- 1x15w



Kod/ Code : A-472
☞☞☞ ----- 1x15w



Kod/ Code : A-473
☞☞☞ ----- 1x15w

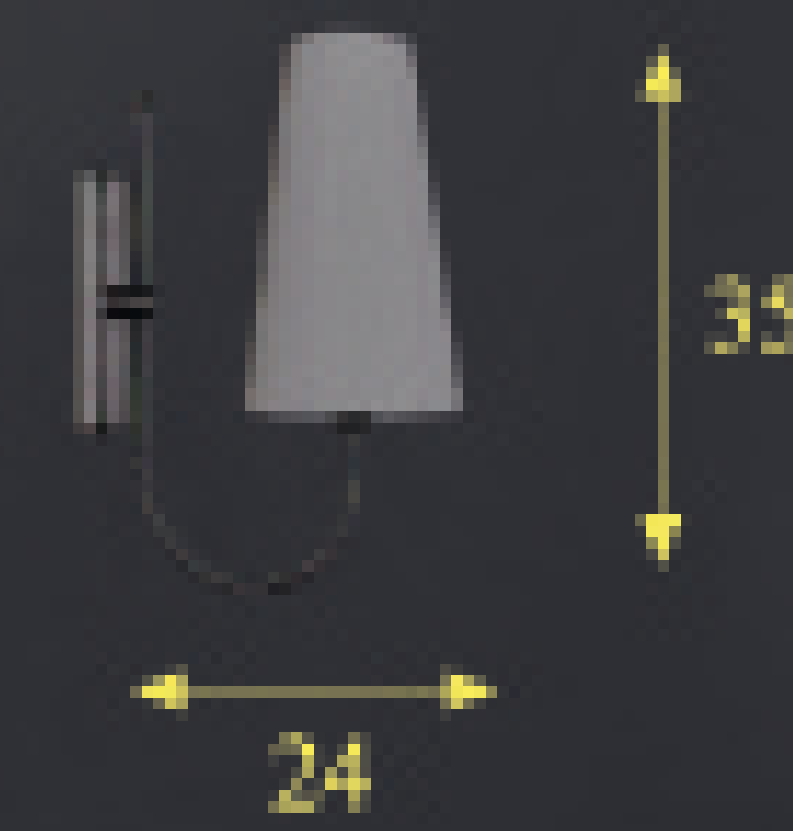

Kod/ Code : A-474
☞☞☞ ----- 1x15w



Kod/ Code : A-475
☞☞☞ ----- 1x15w





Kod/ Code : Avi-600
☞ ----- 5x15w

Kod/ Code : Avi-602
☞ ----- 5x15w



Kod/ Code : Avi-604
 5x15w

Kod/ Code : Avi-606
 5x15w







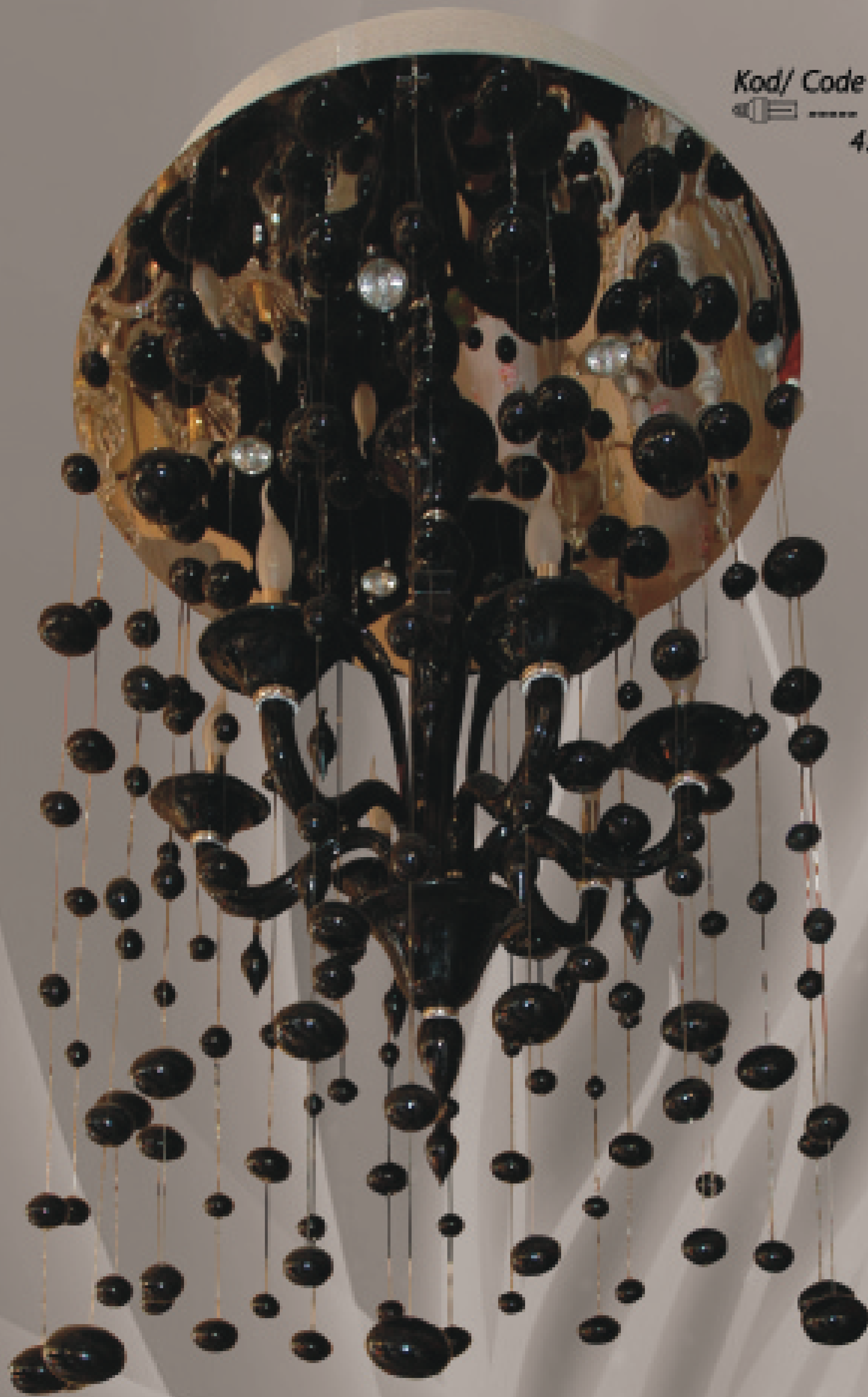

Kod/ Code : Avi-608
☞ ☞ ☞ ☞ ☞ 6x15 w
4x12/50 w



Kod/ Code : Avi-610
☞ ☞ ☞ ☞ ☞ 6x15 w

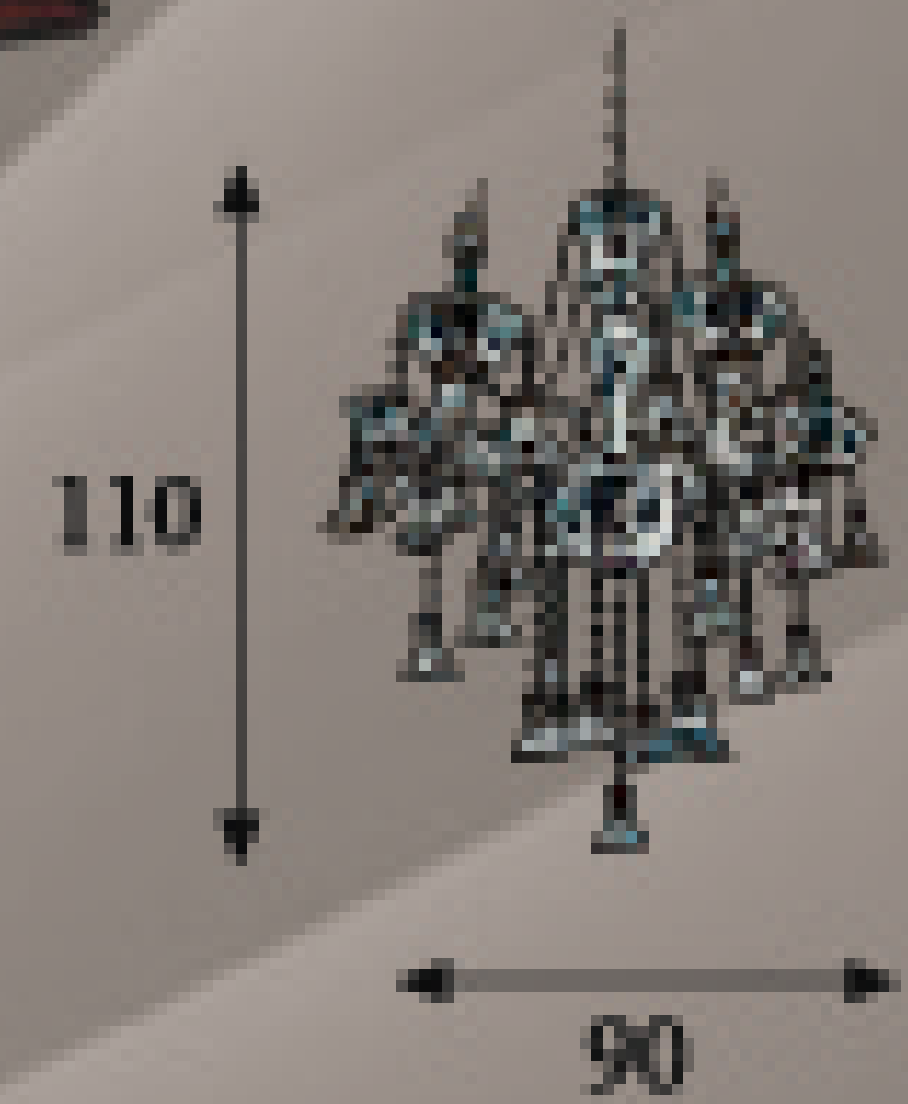

Kod/ Code : Avi-612
☞ ☞ ----- 6x13 w

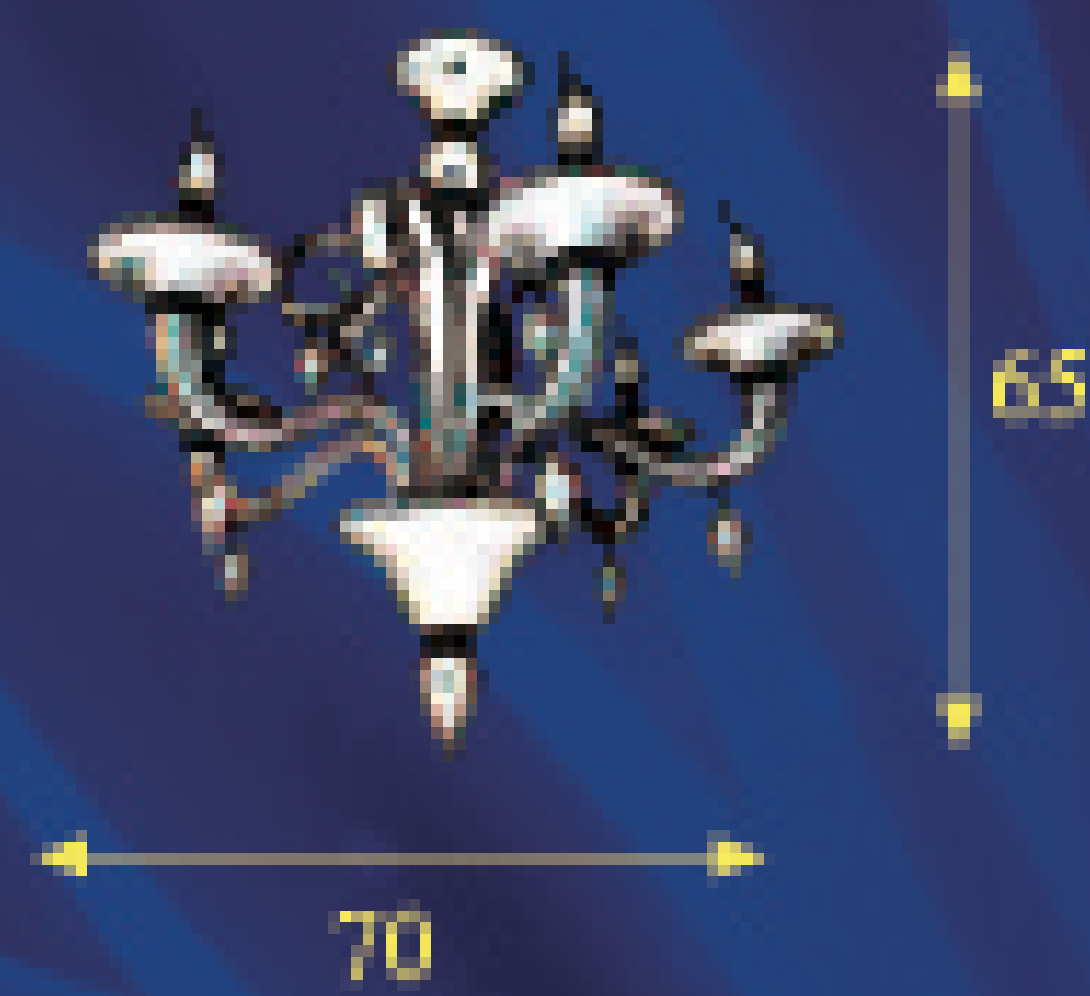

Kod/ Code : Avi-614
☞ ☞ ----- 6x13 w



Kod/ Code : Avi-616

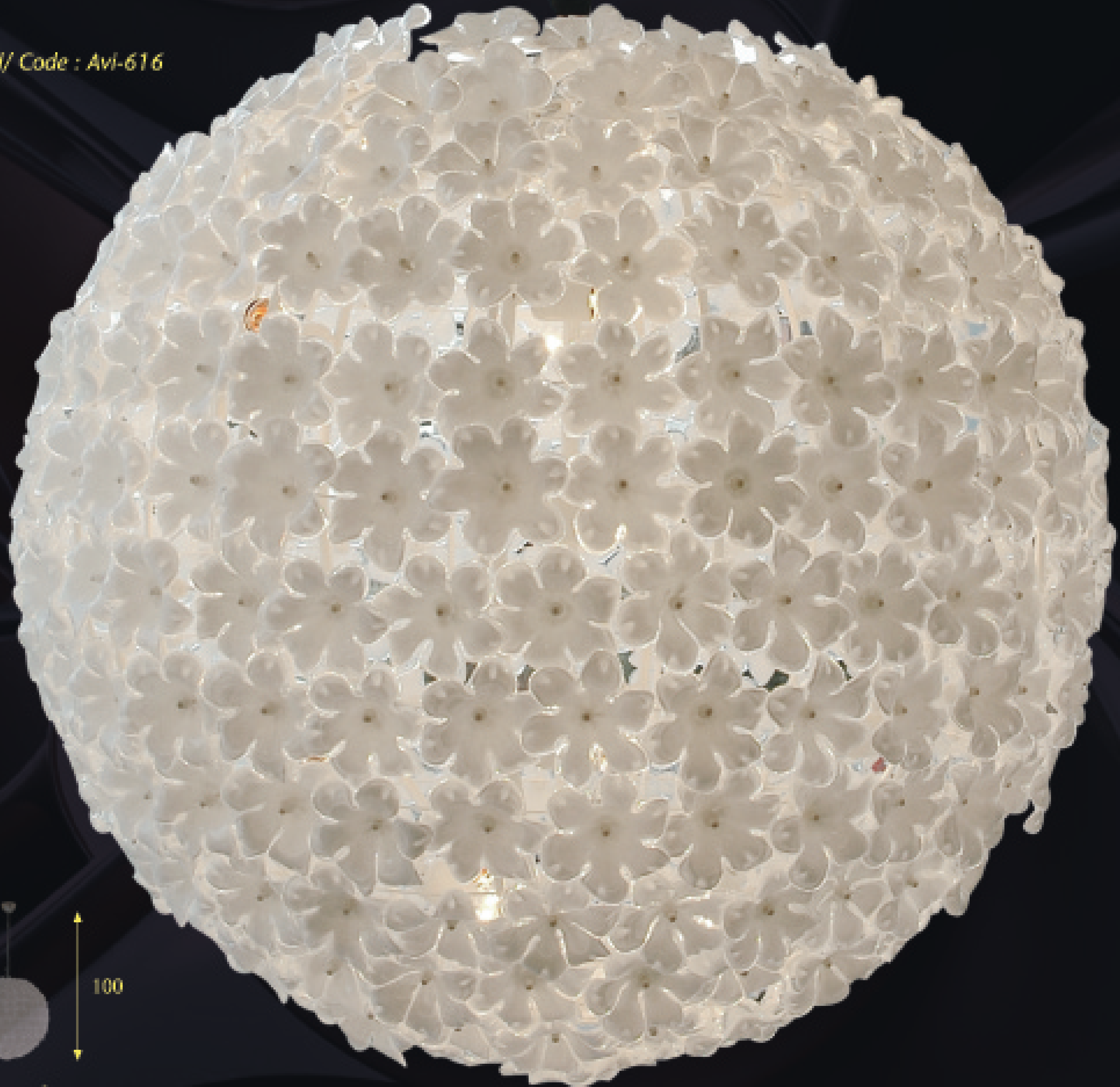



Kod/ Code : Avi-618



Kod/ Code : Avi-620

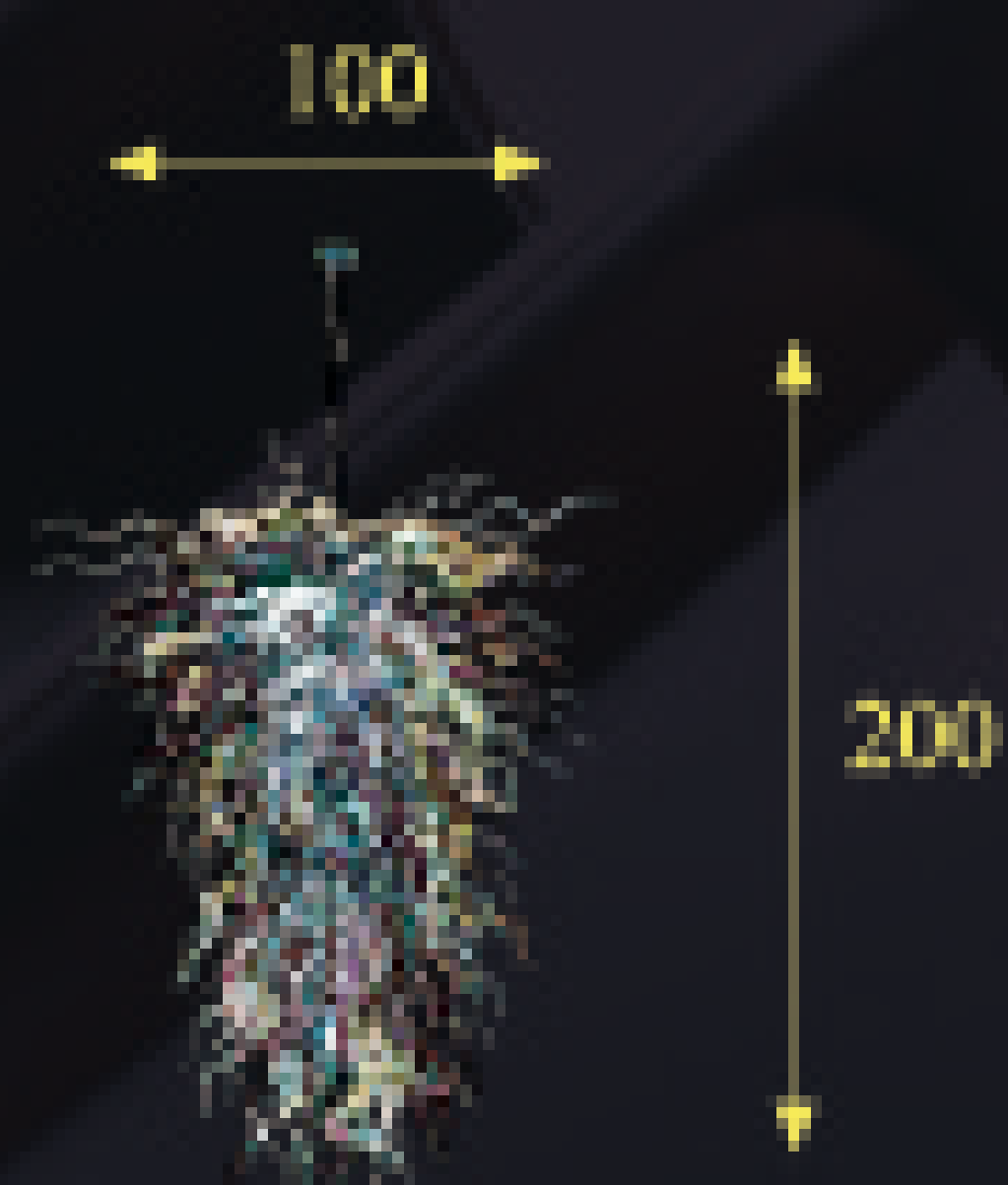

Kod/ Code : Avi-622

Kod/ Code : Avi-624



100

100

230 230



Kod/ Code : Ex -700
☛ ----- 1x20 w



Kod/ Code : Ex -705
☛ ----- 1x20 w

