

**Ampüller**

Enerji Tasarruflu Ampüller	1
Power LED'li Ampüller	5
Akkor Flamanlı Ampüller	9
Reflektörlü Ampüller	10
Floresan Ampüller	13
Işıklı Hortumlar	14

**LED'li Ürünler**

Power LED'li & Multi LED'li Ürünler	15
Şerit LED'li Ürünler	22

**Camlı İç Mekan Armatürleri**

Klasik Tavan Armatürleri	25
Duvar Aplikleri	30
Sensörlü Armatürler	34
Dekoratif Tavan Armatürleri	35
Sarkıtlar	38

**İç ve Dış Mekan Ayd. Armatürleri**

Projektörler	47
Resim Aplikler	48
Spotlar	49
Downlight Armatürler	56
Bant Armatürler	62
Etanj Armatürler	65
Nemli Yer Armatürleri	66
Bahçe Armatürleri	71
Masa Lambaları	80
Işıldaklar ve El Fenerleri	82
Gece Lambaları	86
Balast ve Trafolar	88
Aksesuarlar	89

**Şalt Ürünler**

Otomatik Sigortalar	93
Kaçak Akım ve Yangın Koruma Röleleri	95
Kontaktörler ve Termik Röleler	96
Endüstriyel Röleler	97
Kompakt Şalterler	99
Switchler	102
Kabloşular	104
Sinyal ve Butonlar	106
Buton Kutuları	110

## Enerji Tasarruflu Ampüller



8000 Saat Ömürlü



## Enerji Tasarruflu Mikro Spiral Ampüller - Işıklı Anahtar Uyumlu

	Kod	Renk	Güç	Duy Tipi	Lümen	Koli	Fiyat (USD)
101	<b>VO11009</b>	2700K	9W	E14	400	60	<b>4.60</b>
102	<b>VO11009</b>	6400K	9W	E14	400	60	<b>4.60</b>
103	<b>VO11009</b>	2700K	9W	E27	400	60	<b>4.60</b>
104	<b>VO11009</b>	6400K	9W	E27	400	60	<b>4.60</b>

RÖHS

Çalışma Gerilimi: 220-240V

Radyasyon Filtreli

8000 Saat Ömürlü



## Enerji Tasarruflu Mini Spiral Ampüller - Işıklı Anahtar Uyumlu

	Kod	Renk	Güç	Duy Tipi	Lümen	Koli	Fiyat (USD)
105	<b>VO11009</b>	2700K	9W	E14	400	60	<b>3.80</b>
106	<b>VO11009</b>	6400K	9W	E14	400	60	<b>3.80</b>
107	<b>VO11009</b>	2700K	9W	E27	400	60	<b>3.80</b>
108	<b>VO11009</b>	6400K	9W	E27	400	60	<b>3.80</b>
109	<b>VO11015</b>	2700K	15W	E27	800	60	<b>4.00</b>
110	<b>VO11015</b>	6400K	15W	E27	800	60	<b>4.00</b>

RÖHS

Çalışma Gerilimi: 220-240V

Radyasyon Filtreli

8000 Saat Ömürlü



## Enerji Tasarruflu Standart Spiral Ampüller - Işıklı Anahtar Uyumlu

	Kod	Renk	Güç	Duy Tipi	Lümen	Koli	Fiyat (USD)
111	<b>VO11020</b>	2700K	20W	E27	1080	60	<b>5.00</b>
112	<b>VO11020</b>	6400K	20W	E27	1080	60	<b>5.00</b>
113	<b>VO11025</b>	2700K	25W	E27	1350	60	<b>5.40</b>
114	<b>VO11025</b>	6400K	25W	E27	1350	60	<b>5.40</b>

RÖHS

Çalışma Gerilimi: 220-240V

Radyasyon Filtreli

6000 Saat Ömürlü



## Enerji Tasarruflu Yüksek Wattlı Spiral Ampüller - Işıklı Anahtar Uyumlu

	Kod	Renk	Güç	Duy Tipi	Lümen	Koli	Fiyat (USD)
115	<b>VO11045</b>	6400K	45W	E27	3000	40	<b>16.50</b>
116	<b>VO11065</b>	6400K	65W	E27	4000	40	<b>22.00</b>
117	<b>VO11085</b>	6400K	85W	E27	5000	40	<b>24.50</b>

RÖHS

Çalışma Gerilimi: 220-240V

Radyasyon Filtreli



## Enerji Tasarruflu Tidy Spiral Ampuller - Işıklı Anahtar Uyumlu

Kod	Renk	Güç	Duy Tipi	Lümen	Koli	Fiyat (USD)	
201	<b>VO50227-1316</b>	6400K	13W	E27	650	60	<b>4.10</b>
202	<b>VO50227-1516</b>	6400K	16W	E27	750	60	<b>4.20</b>
203	<b>VO50227-2116</b>	6400K	21W	E27	1050	60	<b>5.40</b>



Radyasyon Filtreli

Çalışma Gerilimi: 220-240V

RÖHS

8000 Saat Ömürlü

## 3 Tüplü Enerji Tasarruflu Ampuller - Işıklı Anahtar Uyumlu

Kod	Renk	Güç	Duy Tipi	Lümen	Koli	Fiyat (USD)	
204	<b>VO11315</b>	2700K	15W	E27	750	60	<b>4.10</b>
205	<b>VO11315</b>	6400K	15W	E27	750	60	<b>4.10</b>
206	<b>VO11320</b>	2700K	20W	E27	1080	60	<b>4.30</b>
207	<b>VO11320</b>	6400K	20W	E27	1080	60	<b>4.30</b>
208	<b>VO11325</b>	2700K	25W	E27	1350	60	<b>5.00</b>
209	<b>VO11325</b>	6400K	25W	E27	1350	60	<b>5.00</b>



Radyasyon Filtreli

Çalışma Gerilimi: 220-240V

RÖHS

8000 Saat Ömürlü

## 4 Tüplü Enerji Tasarruflu Ampuller (4U) - Işıklı Anahtar Uyumlu

Kod	Renk	Güç	Duy Tipi	Lümen	Koli	Fiyat (USD)	
210	<b>VO11411</b>	2700K	11W	E27	570	60	<b>5.10</b>
211	<b>VO11411</b>	6400K	11W	E27	570	60	<b>5.10</b>
212	<b>VO11420</b>	2700K	20W	E27	1100	60	<b>5.30</b>
213	<b>VO11420</b>	6400K	20W	E27	1100	60	<b>5.30</b>



Radyasyon Filtreli

Çalışma Gerilimi: 220-240V

RÖHS

8000 Saat Ömürlü

## PLC Ampul Serisi - PLC Kompakt Floresan Ampul

Kod	Renk	Güç	Duy Tipi	Lümen	Koli	Fiyat (USD)	
214	<b>VO14410</b>	2700K	10W	PLC	560	100	<b>1.45</b>
215	<b>VO14410</b>	6400K	10W	PLC	560	100	<b>1.45</b>
216	<b>VO14413</b>	2700K	13W	PLC	840	100	<b>1.55</b>
217	<b>VO14413</b>	6400K	13W	PLC	840	100	<b>1.55</b>
218	<b>VO14418</b>	2700K	18W	PLC	1120	100	<b>1.65</b>
219	<b>VO14418</b>	6400K	18W	PLC	1120	100	<b>1.65</b>
220	<b>VO14426</b>	2700K	26W	PLC	1600	100	<b>1.90</b>
221	<b>VO14426</b>	6400K	26W	PLC	1600	100	<b>1.90</b>



Çalışma Gerilimi: 220-240V

8000 Saat Ömürlü

## Enerji Tasarruflu Ampüller



## Projektörler İçin R7s Enerji Tasarruflu Spiral Ampüller

	Kod	Renk	Güç	Duy Tipi	Lümen	Koli	Fiyat (USD)
301	<b>VOZ50178-1012</b>	2700K	10W	R7s	550	60	<b>8.90</b>
302	<b>VOZ50178-1016</b>	6400K	10W	R7s	550	60	<b>8.90</b>
303	<b>VOZ50178-2012</b>	2700K	20W	R7s	1100	60	<b>8.90</b>
304	<b>VOZ50178-2016</b>	6400K	20W	R7s	1100	60	<b>8.90</b>

## Projektörler İçin G9 Enerji Tasarruflu Spiral Ampüller

	Kod	Renk	Güç	Duy Tipi	Lümen	Koli	Fiyat (USD)
305	<b>VOZ50209-0712</b>	2700K	7W	G9	350	60	<b>5.60</b>
306	<b>VOZ50209-0716</b>	6400K	7W	G9	350	60	<b>5.60</b>

Radyasyon Filtreli

RÖHS

Çalışma Gerilimi: 220-240V

8000 Saat Ömürlü



## Enerji Tasarruflu Dekoratif Glop Ampüller - Işıklı Anahtar Uyumlu

	Kod	Renk	Güç	Duy Tipi	Lümen	Koli	Fiyat (USD)
307	<b>VOG50227-2012</b>	2700K	11W	E27	540	40	<b>8.60</b>
308	<b>VOG50227-2016</b>	6400K	11W	E27	540	40	<b>8.60</b>

## Enerji Tasarruflu Dekoratif Glop Ampüller - Işıklı Anahtar Uyumlu

	Kod	Renk	Güç	Duy Tipi	Lümen	Koli	Fiyat (USD)
309	<b>VO11105</b>	2700K	5W	E14	150	60	<b>3.95</b>
310	<b>VO11105</b>	6400K	5W	E14	150	60	<b>3.95</b>
311	<b>VO11105</b>	2700K	5W	E27	150	60	<b>3.95</b>
312	<b>VO11105</b>	6400K	5W	E27	150	60	<b>3.95</b>
313	<b>VO12115</b>	6400K	15W	E27	680	40	<b>6.20</b>
314	<b>VO12120</b>	6400K	20W	E27	800	40	<b>7.40</b>
315	<b>VO12125</b>	6400K	25W	E27	1000	40	<b>8.30</b>

Radyasyon Filtreli

RÖHS

Çalışma Gerilimi: 220-240V

8000 Saat Ömürlü



## Klasik Tipi Enerji Tasarruflu Ampüller - Işıklı Anahtar Uyumlu

	Kod	Renk	Güç	Duy Tipi	Lümen	Koli	Fiyat (USD)
316	<b>VO12211</b>	2700K	11W	E27	540	60	<b>6.30</b>
317	<b>VO12211</b>	6400K	11W	E27	540	60	<b>6.30</b>
318	<b>VO12511</b>	2700K	11W	E27	540	60	<b>6.50</b>
319	<b>VO12511</b>	6400K	11W	E27	540	60	<b>6.50</b>

Radyasyon Filtreli

RÖHS

Çalışma Gerilimi: 220-240V

6000 Saat Ömürlü



## Enerji Tasarruflu Dekoratif Ampüller - Işıklı Anahtar Uyumlu

Kod	Renk	Güç	Duy Tipi	Lümen	Koli	Fiyat (USD)
401 VOG50114-1112	2700K	11W	E14	550	60	6.80
402 VOG50114-1116	6400K	11W	E14	550	60	6.80
403 VOG50127-1112	2700K	11W	E27	550	60	6.80
404 VOG50127-1116	6400K	11W	E27	550	60	6.80
405 VO12307	2700K	11W	E14	290	60	5.60
406 VO12307	6400K	11W	E14	290	60	5.60
407 VO12407	2700K	11W	E27	290	60	5.60
408 VO12407	6400K	11W	E27	290	60	5.60



Radyasyon Filtreli

Çalışma Gerilimi: 220-240V

RÖHS

8000 Saat Ömürlü

## Enerji Tasarruflu Reflektör Ampüller - Işıklı Anahtar Uyumlu

Kod	Renk	Güç	Duy Tipi	Lümen	Koli	Fiyat (USD)
409 VO13107	2700K	7W	E14	130	60	6.60
410 VO13107	6400K	7W	E14	130	60	6.60
411 VO13407	2700K	7W	GU10	150	60	6.60
412 VO13407	6400K	7W	GU10	150	60	6.60
413 VO13211	2700K	11W	E27	230	60	7.30
414 VO13211	6400K	11W	E27	230	60	7.30



Çalışma Gerilimi: 220-240V

RÖHS

8000 Saat Ömürlü

## PAR 30 Enerji Tasarruflu Ampül

Kod	Renk	Güç	Duy Tipi	Lümen	Koli	Fiyat (USD)
415 VOZ50427-1512	2700K	15W	E27	600	40	13.20
416 VOZ50427-1516	6400K	15W	E27	600	40	13.20



Çalışma Gerilimi: 220-240V

RÖHS

6000 Saat Ömürlü

## LEDALUX - SMD LED' li Ampül

Kod	Renk	Güç	Duy Tipi	Lümen	Koli	Fiyat (USD)
417 VOM50110-1012	3000K	1.7W	GU10	80	60	11.40
418 VOM50110-1016	6000K	1.7W	GU10	90	60	11.40
419 VOM50105-1012	3000K	1.7W	GU5.3	80	60	11.30
420 VOM50105-1016	6000K	1.7W	GU5.3	90	60	11.30



Çalışma Gerilimi: 220-240V

RÖHS

30000 Saat Ömürlü

## Power LED' li Ampüller

**Lumia - Power LED' li Ampül**

30000 Saat Ömürlü

	Kod	Renk	Güç	Duy Tipi	Lümen	Koli	Fiyat (USD)
501	<b>VOP50627-0112</b>	3000K	6W	E27	210	30	<b>49.90</b>
502	<b>VOP50627-2012</b>	3000K	6W	E27	210	30	<b>49.90</b>
503	<b>VOP50627-0514</b>	4000K	6W	E27	210	30	<b>63.00</b>

RÖHS

Çalışma Gerilimi: 220-240V

**Mini Globe - E27 Duylu Power LED' li Ampül**

30000 Saat Ömürlü

	Kod	Renk	Güç	Duy Tipi	Lümen	Koli	Fiyat (USD)
504	<b>VOP50327-0112</b>	3000K	3W	E27	110	30	<b>26.70</b>
505	<b>VOP50327-0114</b>	4000K	3W	E27	110	30	<b>26.70</b>
506	<b>VOP50327-0712</b>	3000K	3W	E27	110	30	<b>26.70</b>
507	<b>VOP50327-0714</b>	4000K	3W	E27	110	30	<b>26.70</b>

RÖHS

Çalışma Gerilimi: 220-240V

**Mini Globe - E14 Duylu Power LED' li Ampül**

30000 Saat Ömürlü

	Kod	Renk	Güç	Duy Tipi	Lümen	Koli	Fiyat (USD)
508	<b>VOP50314-0112</b>	3000K	3W	E14	110	30	<b>26.70</b>
509	<b>VOP50314-0114</b>	4000K	3W	E14	110	30	<b>26.70</b>
510	<b>VOP50314-0712</b>	3000K	3W	E14	110	30	<b>26.70</b>
511	<b>VOP50314-0714</b>	4000K	3W	E14	110	30	<b>26.70</b>

RÖHS

Çalışma Gerilimi: 220-240V

**Lumia-30 - Power LED' li Ampül**

30000 Saat Ömürlü

	Kod	Renk	Güç	Duy Tipi	Lümen	Koli	Fiyat (USD)
512	<b>VOP50927-0112</b>	3000K	11W	E27	550	20	<b>80.50</b>
513	<b>VOP50927-0114</b>	4000K	11W	E27	550	20	<b>80.50</b>

RÖHS

Çalışma Gerilimi: 220-240V



## Lumia-63 - Power LED' li Ampul

Kod	Renk	Güç	Duy Tipi	Lümen	Koli	Fiyat (USD)
601 <b>VOP51027-0112</b>	3000K	6W	E27	240	30	<b>52.00</b>



30000 Saat Ömürlü

Çalışma Gerilimi: 220-240V

RÖHS LVD

## Ledastar - GU10 Duyulu Power LED' li Ampul

Kod	Renk	Güç	Duy Tipi	Lümen	Koli	Fiyat (USD)
602 <b>VOP50510-0612</b>	3000K	6W	GU10	210	60	<b>49.50</b>
603 <b>VOP50510-0614</b>	4200K	6W	GU10	250	60	<b>49.50</b>



30000 Saat Ömürlü

Çalışma Gerilimi: 220-240V

RÖHS LVD

## Microstar - E14 Duyulu Power LED' li Ampul

Kod	Renk	Güç	Duy Tipi	Lümen	Koli	Fiyat (USD)
604 <b>VOP50114-0312</b>	3000K	3W	E14	90	60	<b>27.80</b>
605 <b>VOP50114-0314</b>	4200K	3W	E14	110	60	<b>27.80</b>
606 <b>VOP50214-0312</b>	3000K	3W	E14	90	60	<b>27.80</b>
607 <b>VOP50214-0314</b>	4200K	3W	E14	110	60	<b>27.80</b>



30000 Saat Ömürlü

Çalışma Gerilimi: 220-240V

RÖHS LVD

## Power LED' li Ampul

Kod	Renk	Güç	Duy Tipi	Lümen	Koli	Fiyat (USD)
608 <b>VO18605</b>	3000K	5W	E27	300	40	<b>44.00</b>
609 <b>VO18605</b>	6000K	5W	E27	300	40	<b>44.00</b>



30000 Saat Ömürlü

Çalışma Gerilimi: 220-240V

RÖHS LVD

Power LED' li Ampüller



GX53 Duylu Spiral Tüplü Ampül

8000 Saat Ömürlü



	Kod	Renk	Güç	Duy Tipi	Lümen	Koli	Fiyat (USD)
701	<b>VOZ50353-1112</b>	2700K	11W	GX53	380	60	<b>8.10</b>
702	<b>VOZ50353-1116</b>	6400K	11W	GX53	380	60	<b>8.10</b>

RÖHS

Çalışma Gerilimi: 220-240V

GX53 Duylu LED' li Ampül

30000 Saat Ömürlü



	Kod	Renk	Güç	Duy Tipi	Lümen	Koli	Fiyat (USD)
703	<b>VOZ50453-0312</b>	3000K	3W	GX53	120	100	<b>38.00</b>
704	<b>VOZ50453-0316</b>	6000K	3W	GX53	120	100	<b>38.00</b>
705	<b>VOZ50453-0350</b>	Kırmızı	3W	GX53	-	100	<b>38.00</b>
706	<b>VOZ50453-0360</b>	Yeşil	3W	GX53	-	100	<b>38.00</b>
707	<b>VOZ50453-0370</b>	Mavi	3W	GX53	-	100	<b>38.00</b>

RÖHS

Çalışma Gerilimi: 220-240V

PAR 30 LED' li Ampul

30000 Saat Ömürlü



	Kod	Renk	Güç	Duy Tipi	Lümen	Koli	Fiyat (USD)
708	<b>VOM50527-0112</b>	3000K	3.6W	E27	125	30	<b>20.10</b>
709	<b>VOM50527-0116</b>	6000K	3.6W	E27	140	30	<b>20.10</b>
710	<b>VOM50527-0150</b>	Mavi	3.6W	E27	-	30	<b>20.10</b>
711	<b>VOM50527-0160</b>	Yeşil	3.6W	E27	-	30	<b>20.10</b>
712	<b>VOM50527-0170</b>	Kırmızı	3.6W	E27	-	30	<b>20.10</b>

RÖHS

Çalışma Gerilimi: 220-240V



**Enerji Tasarruflu Ampüller**



**Enerji Tasarruflu Spiral Ampüller**



6000 Saat Ömürlü

	Kod	Renk	Güç	Duy Tipi	Lümen	Koli	Fiyat (USD)
801	<b>ECN10127-1116</b>	6400K	11W	E27	550	50	<b>3.40</b>
802	<b>ECN10127-1516</b>	6400K	15W	E27	750	50	<b>3.60</b>
803	<b>ECN10127-2016</b>	6400K	20W	E27	1000	50	<b>4.20</b>
804	<b>ECN10127-2516</b>	6400K	25W	E27	1250	50	<b>4.30</b>
805	<b>ECN10127-4516</b>	6400K	45W	E27	2250	25	<b>9.80</b>
806	<b>ECN10127-6516</b>	6400K	65W	E27	3250	25	<b>12.20</b>
807	<b>ECN10127-8516</b>	6400K	85W	E27	4250	20	<b>17.70</b>

Çalışma Gerilimi: 220-240V

**Enerji Tasarruflu 3U Ampüller**



6000 Saat Ömürlü

	Kod	Renk	Güç	Duy Tipi	Lümen	Koli	Fiyat (USD)
808	<b>ECN10327-1516</b>	6400K	15W	E27	750	50	<b>3.35</b>
809	<b>ECN10327-2016</b>	6400K	20W	E27	1000	50	<b>3.75</b>
810	<b>ECN10327-2516</b>	6400K	25W	E27	1250	50	<b>3.85</b>

Çalışma Gerilimi: 220-240V

**Enerji Tasarruflu 4U Ampüller**



6000 Saat Ömürlü

	Kod	Renk	Güç	Duy Tipi	Lümen	Koli	Fiyat (USD)
811	<b>ECN10427-1116</b>	6400K	11W	E27	550	50	<b>3.95</b>
812	<b>ECN10427-2016</b>	6400K	20W	E27	1000	50	<b>4.35</b>

Çalışma Gerilimi: 220-240V

**Power Led Ampül Serisi**



30000 Saat Ömürlü

12V

220-240V

	Kod	Renk	Güç	Duy Tipi	Lümen	Koli	Fiyat (USD)
813	<b>ECN11053-0312</b>	3000K	3W	GU5.3	220	40	<b>31.00</b>
814	<b>ECN11053-0316</b>	6000K	3W	GU5.3	220	40	<b>31.00</b>
815	<b>ECN11010-0312</b>	3000K	3W	GU10	220	40	<b>34.00</b>
816	<b>ECN11010-0316</b>	6000K	3W	GU10	220	40	<b>34.00</b>



## Kıvrık ve Burgulu Buji Ampüller - Akkor Flamanlı

Kod	Renk	Güç	Duy Tipi	Koli	Fiyat (USD)	
901	<b>VT140</b>	Seffaf	40W	E14	100	<b>0.42</b>
902	<b>VT140</b>	Buzlu	40W	E14	100	<b>0.42</b>
903	<b>VT140</b>	Seffaf	60W	E14	100	<b>0.42</b>
904	<b>VT140</b>	Buzlu	60W	E14	100	<b>0.42</b>
905	<b>VT141</b>	Buzlu	60W	E14	100	<b>0.42</b>
906	<b>VT142</b>	Seffaf	60W	E14	100	<b>0.42</b>



VT141

VT142

VT140

## Mum Ampül - Akkor Flamanlı

Kod	Renk	Güç	Duy Tipi	Koli	Fiyat (USD)	
907	<b>VT143</b>	Buzlu	40W	E14	100	<b>0.40</b>
908	<b>VT143</b>	Buzlu	60W	E14	100	<b>0.40</b>
909	<b>VT144</b>	Şeffaf	40W	E14	100	<b>0.40</b>
910	<b>VT144</b>	Soft	40W	E14	100	<b>0.40</b>
911	<b>VT144</b>	Şeffaf	60W	E14	100	<b>0.40</b>
912	<b>VT144</b>	Soft	60W	E14	100	<b>0.40</b>
913	<b>VT145</b>	Buzlu	40W	E27	100	<b>0.40</b>
914	<b>VT145</b>	Buzlu	60W	E27	100	<b>0.40</b>
915	<b>VT146</b>	Soft	40W	E27	100	<b>0.42</b>
916	<b>VT146</b>	Soft	60W	E27	100	<b>0.42</b>



VT145

VT143



VT146

VT144

## Glop Ampül - Akkor Flamanlı

Kod	Renk	Güç	Duy Tipi	Koli	Fiyat (USD)	
917	<b>VT150</b>	Soft	60W	E14	100	<b>0.42</b>
918	<b>VT151</b>	Soft	40W	E14	100	<b>0.42</b>
919	<b>VT152</b>	Şeffaf	60W	E14	100	<b>0.40</b>
920	<b>VT152</b>	Buzlu	60W	E14	100	<b>0.40</b>
921	<b>VT153</b>	Seffaf	40W	E14	100	<b>0.40</b>
922	<b>VT153</b>	Buzlu	40W	E14	100	<b>0.40</b>
923	<b>VT154</b>	Şeffaf	60W	E27	100	<b>0.40</b>
924	<b>VT154</b>	Soft	60W	E27	100	<b>0.40</b>
925	<b>VT155</b>	Şeffaf	40W	E27	100	<b>0.40</b>
926	<b>VT155</b>	Soft	40W	E27	100	<b>0.40</b>
927	<b>VT155</b>	Şeffaf	25W	E27	100	<b>0.40</b>
928	<b>VT155</b>	Soft	25W	E27	100	<b>0.40</b>
929	<b>VT156</b>	Buzlu	60W	E27	100	<b>0.40</b>
930	<b>VT157</b>	Buzlu	40W	E27	100	<b>0.40</b>
931	<b>VT158</b>	Buzlu	60W	E27	100	<b>0.47</b>
932	<b>VT159</b>	Soft	60W	E27	100	<b>0.47</b>
933	<b>VIB21127-6010</b>	Soft	60W	E27	50	<b>2.20</b>
934	<b>VIB21227-0010</b>	Soft	100W	E27	50	<b>2.20</b>
935	<b>VIB21327-6010</b>	Soft	60W	E27	50	<b>3.70</b>
936	<b>VIB21427-0010</b>	Soft	100W	E27	50	<b>3.70</b>



VT150

VT151



VT155

VT154



VT159

VT158



VIB21127

## Reflektörlü Ampüller



## LED'li Çanak Tipi Reflektörlü Ampüller - 18 LED'li



Kod	Renk	Güç	Duy Tipi	Koli	Fiyat (USD)	
1001	GU10LED	Mavi	2.2W	GU10	10/200	4.50
1002	GU10LED	Yeşil	2.2W	GU10	10/200	4.60
1003	GU10LED	Kırmızı	2.2W	GU10	10/200	4.30
1004	GU10LED	Beyaz	2.2W	GU10	10/200	4.60
1005	GU10LED	Sarı	2.2W	GU10	10/200	4.30
1006	JCDRLED	Mavi	2.2W	GU5.3	10/200	4.10
1007	JCDRLED	Yeşil	2.2W	GU5.3	10/200	4.20
1008	JCDRLED	Kırmızı	2.2W	GU5.3	10/200	3.90
1009	JCDRLED	Beyaz	2.2W	GU5.3	10/200	4.20
1010	JCDRLED	Sarı	2.2W	GU5.3	10/200	3.90
1011	JCDRLED	Mavi	2.2W	E27	10/200	4.70
1012	JCDRLED	Yeşil	2.2W	E27	10/200	4.90
1013	JCDRLED	Kırmızı	2.2W	E27	10/200	4.60
1014	JCDRLED	Beyaz	2.2W	E27	10/200	4.90
1015	JCDRLED	Sarı	2.2W	E27	10/200	4.60

## Reflektörlü Akkor Ampül



Kod	Renk	Güç	Duy Tipi	Koli	Fiyat (USD)	
1016	R39	Şeffaf	30W	E14	100	0.82
1017	R39	Şeffaf	40W	E14	100	0.82
1018	R50	Şeffaf	40W	E14	100	0.82
1019	R50	Şeffaf	60W	E14	100	0.82
1020	R63	Şeffaf	60W	E27	100	1.00
1021	R80	Şeffaf	60W	E27	100	1.10
1022	R80	Şeffaf	75W	E27	100	1.10
1023	R80	Şeffaf	100W	E27	100	1.10

## Reflektörlü Halojen Ampül



Kod	Güç	Duy Tipi	Koli	Fiyat (USD)	
1024	VT164 PAR20	50W	E27	100	2.95
1025	VT164 PAR30	75W	E27	50	3.85
1026	VT164 PAR30	100W	E27	50	3.85

## Çanak Tipi Reflektörlü Halojen Ampül - Kapalı



Kod	Güç	Duy Tipi	Koli	Fiyat (USD)	
1027	GU10-35W	35W	GU10	200	1.10
1028	GU10-50W	50W	GU10	200	1.10



### Çanak Tipli Reflektörlü Halojen Ampul - Kapalı

	Kod	Güç	Ç.Gerilimi	Duy Tipi	Koli	Fiyat (USD)
1101	<b>JCDR</b>	35W	220-240V	GU5.3	200	<b>0.74</b>
1102	<b>JCDR</b>	50W	220-240V	GU5.3	200	<b>0.74</b>
1103	<b>JCDR</b>	75W	220-240V	GU5.3	200	<b>0.74</b>



### Çanak Tipli Reflektörlü Halojen Ampul - Açık

	Kod	Güç	Ç.Gerilimi	Duy Tipi	Koli	Fiyat (USD)
1104	<b>JCDR</b>	35W	220-240V	GU5.3	200	<b>0.68</b>
1105	<b>JCDR</b>	50W	220-240V	GU5.3	200	<b>0.68</b>
1106	<b>JCDR</b>	75W	220-240V	GU5.3	200	<b>0.68</b>



### Çanak Tipli Reflektörlü Halojen Ampul - Açık

	Kod	Güç	Ç.Gerilimi	Duy Tipi	Koli	Fiyat (USD)
1107	<b>MR11</b>	20W	220-240V	GU4	400	<b>0.72</b>
1108	<b>MR11</b>	35W	220-240V	GU4	400	<b>0.72</b>
1109	<b>MR11</b>	50W	220-240V	GU4	400	<b>0.72</b>



### Çanak Tipli Renkli Reflektörlü Halojen Ampul - Açık

	Kod	Renk	Güç	Ç.Gerilimi	Duy Tipi	Koli	Fiyat (USD)
1110	<b>JCDR</b>	Kırmızı	50W	220-240V	GU5.3	200	<b>0.82</b>
1111	<b>JCDR</b>	Yeşil	50W	220-240V	GU5.3	200	<b>0.82</b>
1112	<b>JCDR</b>	Sarı	50W	220-240V	GU5.3	200	<b>0.82</b>
1113	<b>JCDR</b>	Mavi	50W	220-240V	GU5.3	200	<b>0.82</b>



### Çanak Tipli Reflektörlü Halojen Ampul - (Trafo ile çalışır) Kapalı

	Kod	Güç	Ç.Gerilimi	Duy Tipi	Koli	Fiyat (USD)
1114	<b>MR16</b>	20W	12V	GU5.3	200	<b>0.53</b>
1115	<b>MR16</b>	35W	12V	GU5.3	200	<b>0.53</b>
1116	<b>MR16</b>	50W	12V	GU5.3	200	<b>0.53</b>



Reflektörlü Ampüller



Çanak Tipli Reflektörlü Halojen Ampul - (Trafo ile çalışır) Açık

	Kod	Güç	Ç.Gerilimi	Duy Tipi	Koli	Fiyat (USD)
1201	MR16	20W	12V	GU5.3	200	<b>0.50</b>
1202	MR16	35W	12V	GU5.3	200	<b>0.50</b>
1203	MR16	50W	12V	GU5.3	200	<b>0.50</b>



Çanak Tipli Renkli Reflektörlü Halojen Ampul - (Trafo ile çalışır) Kapalı

	Kod	Renk	Güç	Duy Tipi	Koli	Fiyat (USD)
1204	CLR-MR16	Kırmızı	50W	GU5.3	200	<b>0.70</b>
1205	CLR-MR16	Yeşil	50W	GU5.3	200	<b>0.70</b>
1206	CLR-MR16	Sarı	50W	GU5.3	200	<b>0.70</b>
1207	CLR-MR16	Mavi	50W	GU5.3	200	<b>0.70</b>



Çanak Tipli Reflektörlü Halojen Ampul - (Trafo ile çalışır) Kapalı

	Kod	Güç	Ç.Gerilimi	Duy Tipi	Koli	Fiyat (USD)
1208	MR11	20W	12V	GU4	10/400	<b>0.58</b>
1209	MR11	35W	12V	GU4	10/400	<b>0.58</b>
1210	MR11	50W	12V	GU4	10/400	<b>0.58</b>



Halojen Kapsul Ampuller

	Kod	Güç	Ç.Gerilimi	Duy Tipi	Koli	Fiyat (USD)
1211	BI-PINJC	10W	12V	G4	100/1000	<b>0.35</b>
1212	BI-PINJC	20W	12V	G4	100/1000	<b>0.35</b>
1213	BI-PINJC	35W	12V	G4	100/1000	<b>0.35</b>
1214	BI-PINJC	50W	12V	G6.35	100/1000	<b>0.35</b>
1215	BI-PINJCD	35W	220-240V	G6.35	100/1000	<b>0.44</b>
1216	BI-PINJCD	50W	220-240V	G6.35	100/1000	<b>0.44</b>



G-9 Halojen Kapsul Ampuller

	Kod	Renk	Güç	Duy Tipi	Koli	Fiyat (USD)
1217	G9	Şeffaf	25W	G9	100/1000	<b>0.73</b>
1218	G9	Buzlu	25W	G9	100/1000	<b>0.80</b>
1219	G9	Şeffaf	40W	G9	100/1000	<b>0.73</b>
1220	G9	Buzlu	40W	G9	100/1000	<b>0.80</b>
1221	G9	Şeffaf	50W	G9	100/1000	<b>0.73</b>
1222	G9	Buzlu	50W	G9	100/1000	<b>0.80</b>

Çalışma Gerilimi: 220-240V



## Florasan Ampüller

Kod	Renk	Güç	Duy Tipi	Koli	Fiyat (USD)	
1301	T4-8W	Beyaz	8W	T4	1/200	1.35
1302	T4-12W	Beyaz	12W	T4	1/200	1.50
1303	T4-16W	Beyaz	16W	T4	1/200	1.80
1304	T4-20W	Beyaz	20W	T4	1/200	2.30
1305	T5-6W	Beyaz	6W	T5	1/500	0.62
1306	T5-8W	Beyaz	8W	T5	1/500	0.66
1307	T5-13W	Beyaz	13W	T5	1/200	1.10
1308	T5-14W	Beyaz	14W	T5	1/200	1.15
1309	T5-21W	Beyaz	21W	T5	1/100	1.60
1310	T5-28W	Beyaz	28W	T5	1/100	1.70
1311	T5BLB-4W	BLB	4W	T5	1/500	1.00
1312	T5BLB-6W	BLB	6W	T5	1/500	1.10
1313	T5BLB-8W	BLB	8W	T5	1/500	1.40
1314	T8-10W	Beyaz	10W	T8	1/200	1.20
1315	T8-15W	Beyaz	15W	T8	1/100	1.25
1316	T8-18W	Beyaz	18W	T8	1/25	1.50
1317	T8-30W	Beyaz	30W	T8	1/25	1.65
1318	T8-36W	Beyaz	36W	T8	1/25	1.90
1319	T8-18W	Mavi	18W	T8	1/25	1.60
1320	T8-36W	Mavi	36W	T8	1/25	2.00
1321	T8-18W	Yeşil	18W	T8	1/25	1.60
1322	T8-36W	Yeşil	36W	T8	1/25	2.00
1323	T8-18W	Kırmızı	18W	T8	1/25	1.60
1324	T8-36W	Kırmızı	36W	T8	1/25	2.00
1325	T8BLB-18W	BLB	18W	T8	1/25	2.90
1326	T8BLB-36W	BLB	36W	T8	1/25	5.00

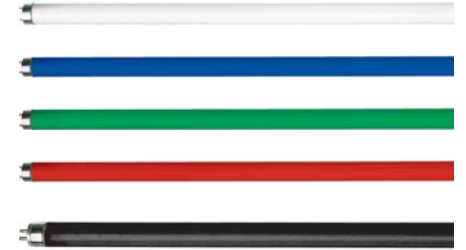
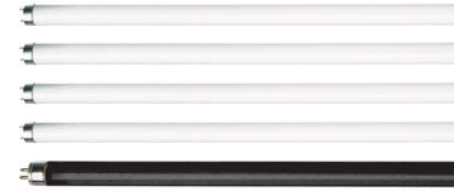
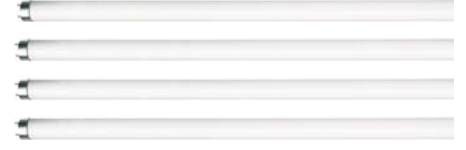

## T-9 Simit Florasan



1327

Kod	T9CIRCLE
Renk	Beyaz
Güç	32W
Duy Tipi	T9
Kutu-Koli	1/20
Fiyat (USD)	3.30

## T-5 Simit Florasan



1328

Kod	T5CIRCLE
Renk	Beyaz
Güç	32W
Duy Tipi	T5
Kutu-Koli	1/30
Fiyat (USD)	3.00

## Simit Armatür

Elektronik Balastlı-Ampüllü



1329

Kod	T532W
Renk	Beyaz
Güç	32W
Duy Tipi	T5
Kutu-Koli	1/20
Fiyat (USD)	7.00

2 Hatlı LED'li Işıklı Hortum - Kontrolöre Uygun



Kod	Renk	Kutu-Koli	Fiyat (USD)
1401	LED.RPL-2LINE Mavi	100m	3.65
1402	LED.RPL-2LINE Renkli	100m	4.10
1403	LED.RPL-2LINE Şeffaf	100m	4.10
1404	LED.RPL-2LINE Yeşil	100m	4.10
1405	LED.RPL-2LINE Turuncu	100m	3.65
1406	LED.RPL-2LINE Kırmızı	100m	3.10
1407	LED.RPL-2LINE Sarı	100m	3.10

2 Hatlı Hortum



Kod	Renk	Kutu-Koli	Fiyat (USD)
1408	RPL-2LINE Mavi	100m	2.00
1409	RPL-2LINE Renkli	100m	2.20
1410	RPL-2LINE Şeffaf	100m	2.00
1411	RPL-2LINE Yeşil	100m	2.00
1412	RPL-2LINE Turuncu	100m	2.00
1413	RPL-2LINE Kırmızı	100m	2.00
1414	RPL-2LINE Sarı	100m	2.00

3 Hatlı Kare 72 LED'li Işıklı Hortum - Kontrolöre Uygun



Kod	Renk	Kutu-Koli	Fiyat (USD)
1415	LED72.RPL-3LINE Mavi	80m	7.30
1416	LED72.RPL-3LINE Renkli	80m	7.80
1417	LED72.RPL-3LINE Beyaz	80m	8.20
1418	LED72.RPL-3LINE Yeşil	80m	8.20
1419	LED72.RPL-3LINE Turuncu	80m	8.20
1420	LED72.RPL-3LINE Kırmızı	80m	5.80
1421	LED72.RPL-3LINE Sarı	80m	5.80

Işıklı Hortum Kontrolörleri



Kod	Model	Kutu-Koli	Fiyat (USD)	
1422	LED.RPL-2LINE/100m	2 Hatlı LED 100m	1/20m	16.50
1423	LED.RPL-2LINE/20m	2 Hatlı LED 20m	1/100m	3.40
1424	LED.RPL-3LINE/100m	3 Hatlı Düz LED 100m	1/20m	18.00
1425	LED.RPL-3LINE/20m	3 Hatlı Düz LED 20m	1/100m	3.80
1426	ROPELIGHT CONT.-2LINE	2 Hatlı 10m	1/100m	3.10

LED Işıklı Perdeler

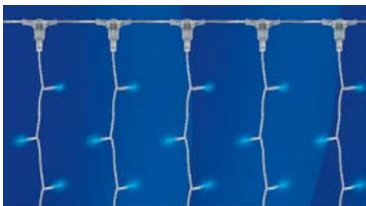

925 LED

Kod	Renk	Kutu-Koli	Fiyat (USD)
1427	VT840 Mavi	8	160.00
1428	VT840 Kırmızı	8	120.00
1429	VT840 Beyaz	8	180.00
1430	VT840 Sıcak Beyaz	8	180.00

Power LED'li Wallwasher



Newton-13/13cm Wallwasher 350 mA - 3 LED' li

Kod	Renk	Lümen	Güç	Fiyat (USD)
1501 VPO10103-0112	2700K	242Lm	4W	75.00
1502 VPO10103-0116	6400K	321Lm	4W	75.00
1503 VPO10103-0144	Amber	156Lm	3W	75.00
1504 VPO10103-0150	Kırmızı	156Lm	3W	75.00
1505 VPO10103-0160	Yeşil	222Lm	4W	75.00
1506 VPO10103-0170	Mavi	72Lm	4W	75.00

Cree LED • Alüminyum Eloksal Kaplama Gövde • 180° Hareketli Gövde • Inox Paslanmaz Vida • Slikon Conta • 7mm Temperli Cam



Kazıklı Newton-13/13cm Wallwasher 350 mA - 3 LED' li

Kod	Renk	Lümen	Güç	Fiyat (USD)
1507 VPO11503-0312	2700K	242Lm	4W	90.00
1508 VPO11503-0316	6400K	321Lm	4W	90.00
1509 VPO11503-0344	Amber	156Lm	3W	90.00
1510 VPO11503-0350	Kırmızı	156Lm	3W	90.00
1511 VPO11503-0360	Yeşil	222Lm	4W	90.00
1512 VPO11503-0370	Mavi	72Lm	4W	90.00

Cree LED • Alüminyum Eloksal Kaplama Gövde • 180° Hareketli Gövde • Inox Paslanmaz Vida • Slikon Conta • 7mm Temperli Cam



Newton-30/30cm Wallwasher 350 mA - 9 LED' li

Kod	Renk	Lümen	Güç	Fiyat (USD)
1513 VPO10109-0112	2700K	725 Lm	12W	170.00
1514 VPO10109-0116	6400K	963 Lm	12W	170.00
1515 VPO10109-0144	Amber	465 Lm	9W	170.00
1516 VPO10109-0150	Kırmızı	465 Lm	9W	170.00
1517 VPO10109-0160	Yeşil	666 Lm	12W	170.00
1518 VPO10109-0170	Mavi	211 Lm	12W	170.00
1519 VPO10109-0172	RGB	-	11W	220.00

Cree LED • Alüminyum Eloksal Kaplama Gövde • 180° Hareketli Gövde • Inox Paslanmaz Vida • Slikon Conta • 7mm Temperli Cam



Newton-40/40cm Wallwasher 350 mA - 12 LED' li

Kod	Renk	Lümen	Güç	Fiyat (USD)
1520 VPO10112-0112	2700K	970Lm	19W	215.00
1521 VPO10112-0116	6400K	1285Lm	19W	215.00
1522 VPO10112-0144	Amber	620Lm	15W	215.00
1523 VPO10112-0150	Kırmızı	620Lm	15W	215.00
1524 VPO10112-0160	Yeşil	890Lm	19W	215.00
1525 VPO10112-0170	Mavi	281Lm	19W	215.00
1526 VPO10112-0172	RGB	-	18W	265.00

Cree LED • Alüminyum Eloksal Kaplama Gövde • 180° Hareketli Gövde • Inox Paslanmaz Vida • Slikon Conta • 7mm Temperli Cam





## Newton-50/50cm Wallwasher 350 mA - 15 LED' li

Kod	Renk	Lümen	Güç	Fiyat (USD)
1601 VPO10115-0112	2700K	1210Lm	19W	<b>290.00</b>
1602 VPO10115-0116	6400K	1605Lm	19W	<b>290.00</b>
1603 VPO10115-0144	Amber	775Lm	15W	<b>290.00</b>
1604 VPO10115-0150	Kırmızı	775Lm	15W	<b>290.00</b>
1605 VPO10115-0160	Yeşil	1108Lm	19W	<b>290.00</b>
1606 VPO10115-0170	Mavi	353Lm	19W	<b>290.00</b>
1607 VPO10115-0172	RGB	-	18W	<b>340.00</b>



Cree LED • Alüminyum Eloksal Kaplama Gövde • 180° Hareketli Gövde • Inox Paslanmaz Vida • Slikon Conta • 7mm Temperli Cam



## Newton-100/100cm Wallwasher 350 mA - 30 LED' li

Kod	Renk	Lümen	Güç	Fiyat (USD)
1608 VPO10130-0112	2700K	2420Lm	38W	<b>490.00</b>
1609 VPO10130-0116	6400K	3210Lm	38W	<b>490.00</b>
1610 VPO10130-0144	Amber	1550Lm	30W	<b>490.00</b>
1611 VPO10130-0150	Kırmızı	1550Lm	30W	<b>490.00</b>
1612 VPO10130-0160	Yeşil	2216Lm	38W	<b>490.00</b>
1613 VPO10130-0170	Mavi	706Lm	38W	<b>490.00</b>
1614 VPO10130-0172	RGB	-	36W	<b>540.00</b>



Cree LED • Alüminyum Eloksal Kaplama Gövde • 180° Hareketli Gövde • Inox Paslanmaz Vida • Slikon Conta • 7mm Temperli Cam



## Radon 8-3 / 8.5cm Bahçe Spotları 350 mA - 3 LED' li

Kod	Renk	Lümen	Güç	Fiyat (USD)
1615 VPO10503-0112	2700K	242Lm	4W	<b>98.00</b>
1616 VPO10503-0116	6400K	321Lm	4W	<b>98.00</b>
1617 VPO10503-0144	Amber	156Lm	3W	<b>98.00</b>
1618 VPO10503-0150	Kırmızı	156Lm	3W	<b>98.00</b>
1619 VPO10503-0160	Yeşil	222Lm	4W	<b>98.00</b>
1620 VPO10503-0170	Mavi	72Lm	4W	<b>98.00</b>



Cree LED • Alüminyum Eloksal Kaplama Gövde • 180° Hareketli Gövde • Inox Paslanmaz Vida • Slikon Conta • 7mm Temperli Cam



## Radon 13-6 / 13.5cm Bahçe Spotları 350 mA - 6 LED' li

Kod	Renk	Lümen	Güç	Fiyat (USD)
1621 VPO10506-0112	2700K	484Lm	8W	<b>185.00</b>
1622 VPO10506-0116	6400K	642Lm	8W	<b>185.00</b>
1623 VPO10506-0144	Amber	312Lm	6W	<b>185.00</b>
1624 VPO10506-0150	Kırmızı	312Lm	6W	<b>185.00</b>
1625 VPO10506-0160	Yeşil	444Lm	8W	<b>185.00</b>
1626 VPO10506-0170	Mavi	144Lm	8W	<b>185.00</b>
1627 VPO10506-0172	RGB	-	7W	<b>235.00</b>



Cree LED • Alüminyum Eloksal Kaplama Gövde • 180° Hareketli Gövde • Inox Paslanmaz Vida • Slikon Conta • 7mm Temperli Cam





**Radon 13-9 / 13.5cm Bahçe Spotları 350 mA - 9 LED' li**

Kod	Renk	Lümen	Güç	Fiyat (USD)	
1701	VPO10509-0112	2700K	725Lm	12W	<b>205.00</b>
1702	VPO10509-0116	6400K	963Lm	12W	<b>205.00</b>
1703	VPO10509-0144	Amber	465Lm	9W	<b>205.00</b>
1704	VPO10509-0150	Kırmızı	465Lm	9W	<b>205.00</b>
1705	VPO10509-0160	Yeşil	666Lm	12W	<b>205.00</b>
1706	VPO10509-0170	Mavi	211Lm	12W	<b>205.00</b>
1707	VPO10509-0172	RGB	-	11W	<b>255.00</b>



Cree LED • Alüminyum Eloksal Kaplama Gövde • 180° Hareketli Gövde • Inox Paslanmaz Vida • Slikon Conta • 7mm Temperli Cam



**Kazıklı Radon G3/ 8.5cm Bahçe Spotları 350 mA - 3 LED' li**

Kod	Renk	Lümen	Güç	Fiyat (USD)	
1708	VPO10503-0312	2700K	242Lm	4W	<b>80.00</b>
1709	VPO10503-0316	6400K	321Lm	4W	<b>80.00</b>
1710	VPO10503-0344	Amber	156Lm	4W	<b>80.00</b>
1711	VPO10503-0350	Kırmızı	156Lm	4W	<b>80.00</b>
1712	VPO10503-0360	Yeşil	222Lm	4W	<b>80.00</b>
1713	VPO10503-0370	Mavi	72Lm	4W	<b>80.00</b>



Cree LED • Alüminyum Eloksal Kaplama Gövde • 180° Hareketli Gövde • Inox Paslanmaz Vida • Slikon Conta • 7mm Temperli Cam • Toprak Zemine Çakılabilir Alüminyum Kazık



**Kazıklı Radon G6 / 13.5cm Bahçe Spotları 350 mA - 6 LED' li**

Kod	Renk	Lümen	Güç	Fiyat (USD)	
1714	VPO10506-0612	2700K	484Lm	12W	<b>175.00</b>
1715	VPO10506-0616	6400K	642Lm	12W	<b>175.00</b>
1716	VPO10506-0644	Amber	312Lm	9W	<b>175.00</b>
1717	VPO10506-0650	Kırmızı	312Lm	9W	<b>175.00</b>
1718	VPO10506-0660	Yeşil	444Lm	12W	<b>175.00</b>
1719	VPO10506-0670	Mavi	144Lm	12W	<b>175.00</b>



Cree LED • Alüminyum Eloksal Kaplama Gövde • 180° Hareketli Gövde • Inox Paslanmaz Vida • Slikon Conta • 7mm Temperli Cam • Toprak Zemine Çakılabilir Alüminyum Kazık



**Kazıklı Radon G6 / 13.5cm Bahçe Spotları 350 mA - 9 LED' li**

Kod	Renk	Lümen	Güç	Fiyat (USD)	
1720	VPO10509-0912	2700K	725Lm	19W	<b>190.00</b>
1721	VPO10509-0916	6400K	963Lm	19W	<b>190.00</b>
1722	VPO10509-0944	Amber	465Lm	15W	<b>190.00</b>
1723	VPO10509-0950	Kırmızı	465Lm	15W	<b>190.00</b>
1724	VPO10509-0960	Yeşil	666Lm	19W	<b>190.00</b>
1725	VPO10509-0970	Mavi	211Lm	19W	<b>190.00</b>



Cree LED • Alüminyum Eloksal Kaplama Gövde • 180° Hareketli Gövde • Inox Paslanmaz Vida • Slikon Conta • 7mm Temperli Cam • Toprak Zemine Çakılabilir Alüminyum Kazık



## Argon-22-18 Power LED'li Projector 350 mA - 18 LED' li

Kod	Renk	Lümen	Güç	Fiyat (USD)	
1801	VPO10818-0112	2700K	2100Lm	38W	<b>380.00</b>
1802	VPO10818-0116	6400K	2700Lm	38W	<b>380.00</b>
1803	VPO10818-0144	Amber	1200Lm	30W	<b>380.00</b>
1804	VPO10818-0150	Kırmızı	1050Lm	30W	<b>380.00</b>
1805	VPO10818-0160	Yeşil	1650Lm	38W	<b>380.00</b>
1806	VPO10818-0170	Mavi	450Lm	38W	<b>380.00</b>
1807	VPO10818-0172	RGB	1050Lm	36W	<b>430.00</b>



Cree LED • Alüminyum Eloksal Kaplama Gövde • 180° Hareketli Gövde • Inox Paslanmaz Vida • Slikon Conta • 7mm Temperli Cam

## Argon-22-18/2 Power LED'li Projector 350 mA - 36 LED' li

Kod	Renk	Lümen	Güç	Fiyat (USD)	
1808	VPO10836-0912	2700K	2100Lm	38W	<b>760.00</b>
1809	VPO10836-0916	6400K	2700Lm	38W	<b>760.00</b>
1810	VPO10836-0944	Amber	1200Lm	30W	<b>760.00</b>
1811	VPO10836-0950	Kırmızı	1050Lm	30W	<b>760.00</b>
1812	VPO10836-0960	Yeşil	1650Lm	38W	<b>760.00</b>
1813	VPO10836-0970	Mavi	450Lm	38W	<b>760.00</b>



Cree LED • Alüminyum Eloksal Kaplama Gövde • 180° Hareketli Gövde • Inox Paslanmaz Vida • Slikon Conta • 7mm Temperli Cam

## Argon 33-36 Power LED'li Projector 350 mA - 36 LED' li

Kod	Renk	Lümen	Güç	Fiyat (USD)	
1814	VPO10836-0112	2700K	2900Lm	36W	<b>650.00</b>
1815	VPO10836-0116	6400K	3852Lm	36W	<b>650.00</b>
1816	VPO10836-0144	Amber	1860Lm	36W	<b>650.00</b>
1817	VPO10836-0150	Kırmızı	1860Lm	36W	<b>650.00</b>
1818	VPO10836-0160	Yeşil	2664Lm	36W	<b>650.00</b>
1819	VPO10836-0170	Mavi	844Lm	36W	<b>650.00</b>
1820	VPO10836-0172	RGB	1860Lm	36W	<b>700.00</b>



Cree LED • Alüminyum Eloksal Kaplama Gövde • 180° Hareketli Gövde • Inox Paslanmaz Vida • Slikon Conta • 7mm Temperli Cam

## Argon 33-36/2 Power LED'li Projector 350 mA - 72 LED' li

Kod	Renk	Lümen	Güç	Fiyat (USD)	
1821	VPO10872-0912	2700K	5800Lm	72W	<b>1,260.00</b>
1822	VPO10872-0916	6400K	7704Lm	72W	<b>1,260.00</b>
1823	VPO10872-0944	Amber	3720Lm	72W	<b>1,260.00</b>
1824	VPO10872-0950	Kırmızı	3720Lm	72W	<b>1,260.00</b>
1825	VPO10872-0960	Yeşil	5328Lm	72W	<b>1,260.00</b>
1826	VPO10872-0970	Mavi	1688Lm	72W	<b>1,260.00</b>



Cree LED • Alüminyum Eloksal Kaplama Gövde • 180° Hareketli Gövde • Inox Paslanmaz Vida • Slikon Conta • 7mm Temperli Cam

Power LED & Multi LED



ARGON-MLED - Bridgelux Multi Led Dış Mekan Aydınlatma

	Kod	Renk	Lümen	Güç	Fiyat (USD)
1901	VML10801-2112	3000K	1695Lm	25W	<b>380.00</b>
1902	VML10801-2114	4500K	1460Lm	25W	<b>340.00</b>
1903	VML10801-2116	6500K	1901Lm	21W	<b>330.00</b>



Cree LED • Alüminyum Eloksal Kaplama Gövde • 180° Hareketli Gövde • Inox Paslanmaz Vida • Slikon Conta • 7mm Temperli Cam



ARGON-2MLED - Bridgelux Multi Led Dış Mekan Aydınlatma

	Kod	Renk	Lümen	Güç	Fiyat (USD)
1904	VML10802-4212	3000K	3390Lm	50W	<b>560.00</b>
1905	VML10802-4214	4500K	2920Lm	50W	<b>470.00</b>
1906	VML10802-4216	6500K	3802Lm	42W	<b>470.00</b>



Cree LED • Alüminyum Eloksal Kaplama Gövde • 180° Hareketli Gövde • Inox Paslanmaz Vida • Slikon Conta • 7mm Temperli Cam



ARGON-4MLED - Bridgelux Multi Led Dış Mekan Aydınlatma

	Kod	Renk	Lümen	Güç	Fiyat (USD)
1907	VML10804-8412	3000K	6780Lm	100W	<b>1,020.00</b>
1908	VML10804-8414	4500K	5840Lm	100W	<b>850.00</b>
1909	VML10804-8416	6500K	7604Lm	84W	<b>840.00</b>



Cree LED • Alüminyum Eloksal Kaplama Gövde • 180° Hareketli Gövde • Inox Paslanmaz Vida • Slikon Conta • 7mm Temperli Cam



Evalux-3 - Spot Modülü 350mA - 45°-60° Lensli 3 LED'li

	Kod	Renk	Lümen	Güç	Fiyat (USD)
1910	VPI16503-0112	2700K	210Lm	4W	<b>22.00</b>
1911	VPI16503-0116	6400K	270Lm	4W	<b>22.00</b>
1912	VPI16503-0144	Amber	120Lm	3W	<b>22.00</b>
1913	VPI16503-0150	Kırmızı	105Lm	3W	<b>22.00</b>
1914	VPI16503-0160	Yeşil	165Lm	4W	<b>22.00</b>
1915	VPI16503-0170	Mavi	45Lm	4W	<b>22.00</b>
1916	VPI16503-0212	2700K	210Lm	4W	<b>22.00</b>
1917	VPI16503-0216	6400K	270Lm	4W	<b>22.00</b>
1918	VPI16503-0244	Amber	120Lm	3W	<b>22.00</b>
1919	VPI16503-0250	Kırmızı	105Lm	3W	<b>22.00</b>
1920	VPI16503-0260	Yeşil	165Lm	4W	<b>22.00</b>
1921	VPI16503-0270	Mavi	45Lm	4W	<b>22.00</b>



LED Driver - 350 mA

	Kod	Güç	Ç. Gerilimi	Adet/Kutu	Fiyat (USD)
1922	VBL40101-0030	3x1W	12V DC	1/40	<b>11.50</b>
1923	VBL40101-0120	12x1W	12V DC	1/40	<b>29.50</b>



### Kanopi Yeni Nesil Multi LED Benzinlik Aydınlatması - 2 Multi LED'li

	Kod	Renk	Lümen	Güç	Fiyat (USD)
2001	<b>VML11002-4216</b>	6500K	3802Lm	42W	<b>580.00</b>
2002	<b>VML11002-5012</b>	4500K	2920Lm	50W	<b>590.00</b>
2003	<b>VML11002-5014</b>	3000K	3390Lm	50W	<b>690.00</b>



Multi LED • Alüminyum Eloksal Gövde • 2mm LED Soğutuculu DKP Saç Ana Gövde • Inox Paslanmaz Vida • 7mm Temperli Cam



### Kanopi Yeni Nesil Multi LED Benzinlik Aydınlatması - 3 Multi LED'li

	Kod	Renk	Lümen	Güç	Fiyat (USD)
2004	<b>VML11003-6316</b>	6500K	5703Lm	63W	<b>890.00</b>
2005	<b>VML11003-7514</b>	4500K	4380Lm	75W	<b>900.00</b>
2006	<b>VML11003-7512</b>	3000K	5085Lm	75W	<b>1,050.00</b>



Multi LED • Alüminyum Eloksal Gövde • 2mm LED Soğutuculu DKP Saç Ana Gövde • Inox Paslanmaz Vida • 7mm Temperli Cam



### Kanopi Yeni Nesil Multi LED Benzinlik Aydınlatması - 4 Multi LED'li

	Kod	Renk	Lümen	Güç	Fiyat (USD)
2007	<b>VML11004-8416</b>	6500K	7604Lm	84W	<b>1,080.00</b>
2008	<b>VML11004-0014</b>	4500K	5840Lm	84W	<b>1,100.00</b>
2009	<b>VML11004-0012</b>	3000K	6780Lm	100W	<b>1,280.00</b>



Multi LED • Alüminyum Eloksal Gövde • 2mm LED Soğutuculu DKP Saç Ana Gövde • Inox Paslanmaz Vida • 7mm Temperli Cam



### Troy-O XPG-Kuyumcu ve Çeyiz Magazaları İçin Geliştirilmiş Sıva Altı Armatür

	Kod	Renk	Lümen	Güç	Fiyat (USD)
2010	<b>VXP10109-2212</b>	3000K	1782Lm	22W	<b>330.00</b>
2011	<b>VXP10109-2114</b>	4200K	2000Lm	21W	<b>330.00</b>
2012	<b>VXP10109-2116</b>	6500K	2002Lm	21W	<b>330.00</b>



Cree LED • Alüminyum Kaplama Gövde • 180° Hareketli Gövde • Inox Paslanmaz Vida • Slikon Conta • 7mm Temperli Cam



### Atom-X - 350mA

	Kod	Renk	Lümen	Güç	Fiyat (USD)
2013	<b>VPI10101-0112</b>	3000K	80.6Lm	1.3W	<b>45.00</b>
2014	<b>VPI10101-0116</b>	6500K	107Lm	1.3W	<b>45.00</b>
2015	<b>VPI10101-0144</b>	Amber	52Lm	1W	<b>45.00</b>
2016	<b>VPI10101-0150</b>	Kırmızı	52Lm	1W	<b>45.00</b>
2017	<b>VPI10101-0160</b>	Yeşil	74Lm	1.3W	<b>45.00</b>
2018	<b>VPI10101-0170</b>	Mavi	24Lm	1.3W	<b>45.00</b>



Driven içindedir





**Nitro İç Mekan Aydınlatma**

	Kod	Renk	Güç	Lümen	Fiyat (USD)
2101	VPO10920-0312	3000K	3.6W	242Lm	80.00
2102	VPO10920-0316	6000K	3.6W	321Lm	80.00
2103	VPO10920-0344	Amber	3.6W	156Lm	80.00
2104	VPO10920-0350	Kırmızı	2.7W	156Lm	80.00
2105	VPO10920-0360	Yeşil	2.7W	222Lm	80.00
2106	VPO10920-0370	Mavi	3.6W	72Lm	80.00
2107	VPO10910-0312	3000K	3.6W	242Lm	80.00
2108	VPO10910-0316	6000K	3.6W	321Lm	80.00
2109	VPO10910-0344	Amber	3.6W	156Lm	80.00
2110	VPO10910-0350	Kırmızı	2.7W	156Lm	80.00
2111	VPO10910-0360	Yeşil	2.7W	222Lm	80.00
2112	VPO10910-0370	Mavi	3.6W	72Lm	80.00
2113	VPO10983-0312	3000K	3.6W	242Lm	80.00
2114	VPO10983-0316	6000K	3.6W	321Lm	80.00
2115	VPO10983-0344	Amber	3.6W	156Lm	80.00
2116	VPO10983-0350	Kırmızı	2.7W	156Lm	80.00
2117	VPO10983-0360	Yeşil	2.7W	222Lm	80.00
2118	VPO10983-0370	Mavi	3.6W	72Lm	80.00



Cree LED • Alüminyum Taban ve Gövde • Mafsalsız Hareketli LED Gövde • Inox Paslanmaz Vida



**Helix - Yatakbası Okuma Lambaları**

	Kod	Renk	Güç	Lümen	Koli	Fiyat (USD)
2119	VPO10901-0112	2700K	1.2W	80.6	4	58.00
2120	VPO10901-0116	6400K	1.2W	107	4	58.00
2121	VPO10902-0112	2700K	0.9W	52	4	58.00
2122	VPO10902-0116	6400K	0.9W	52	4	58.00
2123	VPO10903-0112	2700K	1.2W	1350	4	58.00
2124	VPO10903-0116	6400K	1.2W	1350	4	58.00



Cree LED • Alüminyum Taban ve Gövde • Metal Spiral • Inox Paslanmaz Vida



**Inova - Sıvaaltı LED'li Armatur**

	Kod	Renk	Lümen	Güç	Fiyat (USD)
2125	VPO11009-0912	2700K	725Lm	9W	170.00
2126	VPO11009-0916	6400K	963Lm	9W	170.00
2127	VPO11009-0944	Amber	465Lm	9W	170.00
2128	VPO11009-0950	Kırmızı	465Lm	9W	170.00
2129	VPO11009-0960	Yeşil	666Lm	9W	170.00
2130	VPO11009-0970	Mavi	211Lm	9W	170.00



Cree LED • Alüminyum Gövde • 260° Hareketli Gövde • 7 mm Temperli Cam



## İç Mekan Led Şerit-1m 60LED

Kod	Renk	Güç	Kutu/Koli	Fiyat (USD)
2201 VRL10101-0112	Sıcak Beyaz	5W/m	5/100	9.20
2202 VRL10101-0116	Soğuk Beyaz	5W/m	5/100	9.20
2203 VRL10101-0140	Sarı	5W/m	5/100	9.20
2204 VRL10101-0150	Kırmızı	5W/m	5/100	9.20
2205 VRL10101-0160	Yeşil	5W/m	5/100	9.20
2206 VRL10101-0170	Mavi	5W/m	5/100	9.20

## İç Mekan Led Şerit-1m 30LED / 3 Çipli

Kod	Renk	Güç	Kutu/Koli	Fiyat (USD)
2207 VRL10201-0112	Sıcak Beyaz	7.2W/m	5/100	17.20
2208 VRL10201-0116	Soğuk Beyaz	7.2W/m	5/100	17.20
2209 VRL10201-0172	RGB	7.2W/m	5/100	17.20

## İç Mekan Led Şerit-1m 60LED / 3 Çipli

Kod	Renk	Güç	Kutu/Koli	Fiyat (USD)
2210 VRL10203-0112	Sıcak Beyaz	14.4W/m	5/100	29.00
2211 VRL10203-0116	Soğuk Beyaz	14.4W/m	5/100	29.00
2212 VRL10203-0172	RGB	14.4W/m	5/100	29.00



## Dış Mekan Led Şerit-1m 60LED - IP68

Kod	Renk	Güç	Kutu/Koli	Fiyat (USD)
2213 VRL10104-0112	Sıcak Beyaz	5W/m	5/100	11.95
2214 VRL10104-0116	Soğuk Beyaz	5W/m	5/100	11.95
2215 VRL10104-0140	Sarı	5W/m	5/100	11.95
2216 VRL10104-0150	Kırmızı	5W/m	5/100	11.95
2217 VRL10104-0160	Yeşil	5W/m	5/100	11.95
2218 VRL10104-0170	Mavi	5W/m	5/100	11.95

## Dış Mekan Led Şerit-1m 30LED / 3 Çipli IP68

Kod	Renk	Güç	Kutu/Koli	Fiyat (USD)
2219 VRL10204-0112	Sıcak Beyaz	7.2W/m	5/100	20.60
2220 VRL10204-0116	Soğuk Beyaz	7.2W/m	5/100	20.60
2221 VRL10204-0172	RGB	7.2W/m	5/100	20.60

## Dış Mekan Led Şerit-1m 60LED / 3 Çipli IP68

Kod	Renk	Güç	Kutu/Koli	Fiyat (USD)
2222 VRL10206-0112	Sıcak Beyaz	14.4W/m	5/100	32.30
2223 VRL10206-0116	Soğuk Beyaz	14.4W/m	5/100	32.30
2224 VRL10206-0172	RGB	14.4W/m	5/100	32.30



## Led Şerit Yardımcı Ekipmanları



## Şerit LED için Güç Kaynağı



Kod	Güç	Koruma Sınıfı	Amper	Kutu/Koli	Fiyat (USD)	
2301	<b>VT843</b>	15W	IP66	1.25A	35	<b>17.50</b>
2302	<b>VT843</b>	30W	IP66	2.5A	50	<b>27.60</b>
2303	<b>VT843</b>	40W	IP66	3.5A	30	<b>52.00</b>
2304	<b>VT843</b>	60W	IP66	5A	10	<b>59.00</b>
2305	<b>VT843</b>	100W	IP66	8A	20	<b>92.00</b>



## Şerit LED için Kontrolör

Kod	Güç	Kutu/Koli	Fiyat (USD)	
2306	<b>VT844</b>	250W	1/20	<b>58.00</b>

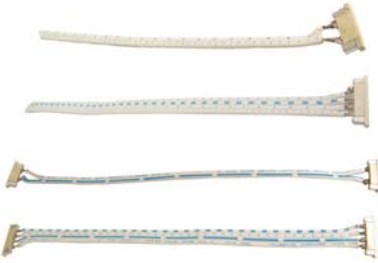

## Şerit LED Birleştirici Eleman

Kod	Tip	Kutu/Koli	Fiyat (USD)	
2307	<b>VCB49801-0110</b>	Mono-1Kafa	250	<b>0.40</b>
2308	<b>VCB49801-0210</b>	RGB-1Kafa	250	<b>0.52</b>
2309	<b>VCB49801-0310</b>	Mono-2Kafa	250	<b>1.55</b>
2310	<b>VCB49801-0410</b>	RGB-2Kafa	250	<b>1.75</b>



# Karanlıktaki gözünüz...

# raina®



**VitoLED ürünler  
şık, kaliteli tasarımları ve  
geniş ürün yelpazesıyla  
hem sizi hem doğayı korur**



[www.raina.com.tr](http://www.raina.com.tr)



# vitoLED®

Klasik Tavan Armatürleri



**Riva 300** <



2501

Kod	10 01 10
Renk	Beyaz
Güç	1x60W
Duy Tipi	E27
Koli	12
Fiyat	<b>14.50 TL</b>

**Riva 300** <



2502

Kod	10 01 82
Renk	Krom
Güç	1x60W
Duy Tipi	E27
Koli	12
Fiyat	<b>23.50 TL</b>

**Riva 1/2 Aplik** <



2503

Kod	10 02 10
Renk	Beyaz
Güç	1x60W
Duy Tipi	E27
Koli	24
Fiyat	<b>9.90 TL</b>

**Riva 1/2 Aplik** <



2504

Kod	10 02 82
Renk	Krom
Güç	1x60W
Duy Tipi	E27
Koli	24
Fiyat	<b>15.50 TL</b>

**Kilyos 250** <



2505

Kod	10 03 10
Renk	Beyaz
Güç	1x60W
Duy Tipi	E27
Koli	20
Fiyat	<b>17.50 TL</b>

**Kilyos 250** <



2506

Kod	10 03 82
Renk	Krom
Güç	1x60W
Duy Tipi	E27
Koli	20
Fiyat	<b>23.50 TL</b>

**Kilyos 300** <



2507

Kod	10 04 10
Renk	Beyaz
Güç	2x60W
Duy Tipi	E27
Koli	10
Fiyat	<b>20.00 TL</b>

**Kilyos 300** <



2508

Kod	10 04 82
Renk	Krom
Güç	2x60W
Duy Tipi	E27
Koli	10
Fiyat	<b>27.50 TL</b>

**Kilyos 400** <



2509

Kod	10 05 10
Renk	Beyaz
Güç	3x60W
Duy Tipi	E27
Koli	10
Fiyat	<b>27.60 TL</b>

**Kilyos 400** <



2510

Kod	10 05 82
Renk	Krom
Güç	3x60W
Duy Tipi	E27
Koli	10
Fiyat	<b>37.00 TL</b>

**Kilyos 1/2 Aplik** <



2511

Kod	10 06 10
Renk	Beyaz
Güç	1x60W
Duy Tipi	E27
Koli	24
Fiyat	<b>11.80 TL</b>

**Kilyos 1/2 Aplik** <



2512

Kod	10 06 82
Renk	Krom
Güç	1x60W
Duy Tipi	E27
Koli	24
Fiyat	<b>16.50 TL</b>



## Ayazma 250



2601

Kod	10 11 10
Renk	Beyaz
Güç	1x60W
Duy Tipi	E27
Koli	20
Fiyat	<b>17.50 TL</b>

## Ayazma 250



2602

Kod	10 11 82
Renk	Krom
Güç	1x60W
Duy Tipi	E27
Koli	20
Fiyat	<b>23.50 TL</b>

## Ayazma 300



2603

Kod	10 12 10
Renk	Beyaz
Güç	2x60W
Duy Tipi	E27
Koli	12
Fiyat	<b>20.00 TL</b>

## Ayazma 300



2604

Kod	10 12 82
Renk	Krom
Güç	2x60W
Duy Tipi	E27
Koli	12
Fiyat	<b>27.50 TL</b>

## Ayazma 400



2605

Kod	10 13 10
Renk	Beyaz
Güç	3x60W
Duy Tipi	E27
Koli	10
Fiyat	<b>27.60 TL</b>

## Ayazma 400



2606

Kod	10 13 82
Renk	Krom
Güç	3x60W
Duy Tipi	E27
Koli	10
Fiyat	<b>37.00 TL</b>

## Side 250



2607

Kod	11 01 90
Renk	Ketan
Güç	1x60W
Duy Tipi	E27
Koli	20
Fiyat	<b>13.50 TL</b>

## Side 250



2608

Kod	11 01 91
Renk	Kaptan
Güç	1x60W
Duy Tipi	E27
Koli	20
Fiyat	<b>13.50 TL</b>

## Side 250



2609

Kod	11 01 92
Renk	Güneş
Güç	1x60W
Duy Tipi	E27
Koli	20
Fiyat	<b>13.50 TL</b>

## Side 300



2610

Kod	11 02 90
Renk	Ketan
Güç	2x60W
Duy Tipi	E27
Koli	12
Fiyat	<b>17.30 TL</b>

## Side 300



2611

Kod	11 02 91
Renk	Kaptan
Güç	2x60W
Duy Tipi	E27
Koli	12
Fiyat	<b>17.30 TL</b>

## Side 300



2612

Kod	11 02 92
Renk	Güneş
Güç	2x60W
Duy Tipi	E27
Koli	12
Fiyat	<b>17.30 TL</b>

Klasik Tavan Armatürleri



Side 400



2701

Kod	11 03 90
Renk	Keten
Güç	3x60W
Duy Tipi	E27
Koli	5
Fiyat	<b>27.90 TL</b>

Side 400



2702

Kod	11 03 91
Renk	Kaptan
Güç	3x60W
Duy Tipi	E27
Koli	5
Fiyat	<b>27.90 TL</b>

Side 400



2703

Kod	11 03 92
Renk	Güneş
Güç	3x60W
Duy Tipi	E27
Koli	5
Fiyat	<b>27.90 TL</b>

Side 1/2 Aplik



2704

Kod	11 04 90
Renk	Keten
Güç	1x60W
Duy Tipi	E27
Koli	24
Fiyat	<b>11.90 TL</b>

Side 1/2 Aplik



2705

Kod	11 04 91
Renk	Kaptan
Güç	1x60W
Duy Tipi	E27
Koli	24
Fiyat	<b>11.90 TL</b>

Side 1/2 Aplik



2706

Kod	11 04 92
Renk	Güneş
Güç	1x60W
Duy Tipi	E27
Koli	24
Fiyat	<b>11.90 TL</b>

Teos 250



2707

Kod	11 05 10
Renk	Beyaz
Güç	1x60W
Duy Tipi	E27
Koli	20
Fiyat	<b>13.50 TL</b>

Teos 250



2708

Kod	11 05 30
Renk	Mavi
Güç	1x60W
Duy Tipi	E27
Koli	20
Fiyat	<b>13.50 TL</b>

Teos 250



2709

Kod	11 05 40
Renk	Kahverengi
Güç	1x60W
Duy Tipi	E27
Koli	20
Fiyat	<b>13.50 TL</b>

Teos 300



2710

Kod	11 06 10
Renk	Beyaz
Güç	2x60W
Duy Tipi	E27
Koli	12
Fiyat	<b>17.30 TL</b>

Teos 300



2711

Kod	11 06 30
Renk	Mavi
Güç	2x60W
Duy Tipi	E27
Koli	12
Fiyat	<b>17.30 TL</b>

Teos 300



2712

Kod	11 06 40
Renk	Kahverengi
Güç	2x60W
Duy Tipi	E27
Koli	12
Fiyat	<b>17.30 TL</b>



## Teos 400



2801

Kod	11 07 10
Renk	Beyaz
Güç	3x60W
Duy Tipi	E27
Koli	5
Fiyat	<b>27.90 TL</b>

## Teos 400



2802

Kod	11 07 30
Renk	Mavi
Güç	3x60W
Duy Tipi	E27
Koli	5
Fiyat	<b>27.90 TL</b>

## Teos 400



2803

Kod	11 07 40
Renk	Kahverengi
Güç	3x60W
Duy Tipi	E27
Koli	5
Fiyat	<b>27.90 TL</b>

## Teos 1/2 Aplik



2804

Kod	11 08 10
Renk	Beyaz
Güç	1x60W
Duy Tipi	E27
Koli	24
Fiyat	<b>11.90 TL</b>

## Teos 1/2 Aplik



2805

Kod	11 08 30
Renk	Mavi
Güç	1x60W
Duy Tipi	E27
Koli	24
Fiyat	<b>11.90 TL</b>

## Teos 1/2 Aplik



2806

Kod	11 08 40
Renk	Kahverengi
Güç	1x60W
Duy Tipi	E27
Koli	24
Fiyat	<b>11.90 TL</b>

## Asus 250



2807

Kod	11 09 22
Renk	Pembe
Güç	1x60W
Duy Tipi	E27
Koli	1/20
Fiyat	<b>13.50 TL</b>

## Asus 250



2808

Kod	11 09 30
Renk	Mavi
Güç	1x60W
Duy Tipi	E27
Koli	1/20
Fiyat	<b>13.50 TL</b>

## Asus 250



2809

Kod	11 09 40
Renk	Kahverengi
Güç	1x60W
Duy Tipi	E27
Koli	1/20
Fiyat	<b>13.50 TL</b>

## Asus 300



2810

Kod	11 10 22
Renk	Pembe
Güç	2x60W
Duy Tipi	E27
Koli	12
Fiyat	<b>17.30 TL</b>

## Asus 300



2811

Kod	11 10 30
Renk	Mavi
Güç	2x60W
Duy Tipi	E27
Koli	12
Fiyat	<b>17.30 TL</b>

## Asus 300



2812

Kod	11 10 40
Renk	Kahverengi
Güç	2x60W
Duy Tipi	E27
Koli	12
Fiyat	<b>17.30 TL</b>

Klasik Tavan Armatürleri



**Asus 400**



2901

Kod	11 11 22
Renk	Pembe
Güç	3x60W
Duy Tipi	E27
Koli	5
Fiyat	<b>27.90 TL</b>

**Asus 400**



2902

Kod	11 11 30
Renk	Mavi
Güç	3x60W
Duy Tipi	E27
Koli	5
Fiyat	<b>27.90 TL</b>

**Asus 400**



2903

Kod	11 11 40
Renk	Kahverengi
Güç	3x60W
Duy Tipi	E27
Koli	5
Fiyat	<b>27.90 TL</b>

**Asus 1/2 Aplik**



2904

Kod	11 12 22
Renk	Pembe
Güç	1x60W
Duy Tipi	E27
Koli	24
Fiyat	<b>11.90 TL</b>

**Asus 1/2 Aplik**



2905

Kod	11 12 30
Renk	Mavi
Güç	1x60W
Duy Tipi	E27
Koli	24
Fiyat	<b>11.90 TL</b>

**Asus 1/2 Aplik**



2906

Kod	11 12 40
Renk	Kahverengi
Güç	1x60W
Duy Tipi	E27
Koli	24
Fiyat	<b>11.90 TL</b>

**Rodos Aplik**



2907

Kod	71 01 10
Renk	Beyaz
Güç	1x60W
Duy Tipi	E27
Koli	24
Fiyat	<b>7.50 TL</b>

**Rodos Aplik**



2908

Kod	71 01 23
Renk	Somon
Güç	1x60W
Duy Tipi	E27
Koli	24
Fiyat	<b>7.50 TL</b>

**Midilli Flat 250**



2909

Kod	70 01 10
Renk	Beyaz
Güç	1x40W
Duy Tipi	E27
Koli	24
Fiyat	<b>7.50 TL</b>

**Midilli Flat 250**



2910

Kod	70 01 23
Renk	Somon
Güç	1x40W
Duy Tipi	E27
Koli	24
Fiyat	<b>7.50 TL</b>

**Midilli Globe 250**



2911

Kod	70 02 10
Renk	Beyaz
Güç	1x40W
Duy Tipi	E27
Koli	24
Fiyat	<b>7.50 TL</b>

**Midilli Globe 250**



2912

Kod	70 02 23
Renk	Somon
Güç	1x40W
Duy Tipi	E27
Koli	24
Fiyat	<b>7.50 TL</b>

Klasik Tavan Armatürü-Plastik

Klasik Duvar Armatürü-Plastik



## Dragos



3001

Kod	20 01 90
Renk	Keten
Güç	1x60W
Duy Tipi	E27
Koli	30
Fiyat	<b>10.90 TL</b>

## Dragos



3002

Kod	20 01 91
Renk	Örümcek
Güç	1x60W
Duy Tipi	E27
Koli	30
Fiyat	<b>10.90 TL</b>

## Dragos



3003

Kod	20 01 92
Renk	Gemici
Güç	1x60W
Duy Tipi	E27
Koli	30
Fiyat	<b>10.90 TL</b>

## Dragos



3004

Kod	20 01 93
Renk	Gölge
Güç	1x60W
Duy Tipi	E27
Koli	30
Fiyat	<b>10.90 TL</b>

## Dragos



3005

Kod	20 01 94
Renk	Maus
Güç	1x60W
Duy Tipi	E27
Koli	30
Fiyat	<b>10.90 TL</b>

## İstinye



3006

Kod	20 02 90
Renk	Keten
Güç	1x60W
Duy Tipi	E27
Koli	30
Fiyat	<b>12.00 TL</b>

## Hisar



3007

Kod	20 03 90
Renk	Opal
Güç	1x60W
Duy Tipi	E27
Koli	24
Fiyat	<b>12.00 TL</b>

## Florya 300



3008

Kod	20 07 90
Renk	Krom
Güç	2x60W
Duy Tipi	E14
Koli	24
Fiyat	<b>23.00 TL</b>

## Florya 400



3009

Kod	20 08 90
Renk	Krom
Güç	2x60W
Duy Tipi	E14
Koli	24
Fiyat	<b>26.00 TL</b>

## Florya 600



3010

Kod	20 09 90
Renk	Krom
Güç	3x60W
Duy Tipi	E14
Koli	16
Fiyat	<b>37.00 TL</b>

## Bodrum



3011

Kod	20 10 90
Renk	Krom
Güç	1x60W
Duy Tipi	G9
Koli	24
Fiyat	<b>21.00 TL</b>

## Marmaris



3012

Kod	20 11 90
Renk	Krom
Güç	1x60W
Duy Tipi	E14
Koli	24
Fiyat	<b>23.00 TL</b>

Duvar Aplikleri



**Didim** <



3101

Kod	20 12 90
Renk	Krom
Güç	1x60W
Duy Tipi	E14
Koli	24
Fiyat	<b>23.00 TL</b>

**Milas** <



3102

Kod	20 13 90
Renk	Krom
Güç	1x60W
Duy Tipi	E14
Koli	24
Fiyat	<b>23.00 TL</b>

**Lydia** <



3103

Kod	20 14 90
Renk	Keten
Güç	1x60W
Duy Tipi	E27
Koli	16
Fiyat	<b>16.00 TL</b>

**Lydia** <



3104

Kod	20 14 91
Renk	Line
Güç	1x60W
Duy Tipi	E27
Koli	16
Fiyat	<b>16.00 TL</b>

**Lydia** <



3105

Kod	20 14 92
Renk	Prizma
Güç	1x60W
Duy Tipi	E27
Koli	16
Fiyat	<b>16.00 TL</b>

**Lydia** <



3106

Kod	20 14 93
Renk	Rubik
Güç	1x60W
Duy Tipi	E27
Koli	16
Fiyat	<b>16.00 TL</b>

**Lydia** <



3107

Kod	20 14 94
Renk	Afacan
Güç	1x60W
Duy Tipi	E27
Koli	16
Fiyat	<b>16.00 TL</b>

**Lydia** <



3108

Kod	20 14 95
Renk	Snowman
Güç	1x60W
Duy Tipi	E27
Koli	16
Fiyat	<b>16.00 TL</b>

**Dicle - Tekli** <



3109

Kod	21 07 12
Renk	Mat Krom
Güç	1x60W
Duy Tipi	E14
Koli	20
Fiyat	<b>22.00 TL</b>

**Dicle - ikili** <



3110

Kod	21 08 12
Renk	Mat Krom
Güç	2x60W
Duy Tipi	E14
Koli	20
Fiyat	<b>38.00 TL</b>

**Fırat - Tekli** <



3111

Kod	21 21 12
Renk	Mat Krom
Güç	1x60W
Duy Tipi	E14
Koli	20
Fiyat	<b>22.00 TL</b>

**Fırat - ikili** <



3112

Kod	21 22 12
Renk	Mat Krom
Güç	2x60W
Duy Tipi	E14
Koli	20
Fiyat	<b>38.00 TL</b>





## Truva



3201

Kod	20 20 10
Renk	Mat Krom
Güç	1x60W
Duy Tipi	E14
Koli	10
Fiyat	<b>30.50 TL</b>

## Anamur Spiral - Tekli



3202

Kod	22 01 10
Renk	Mat Krom
Güç	1x60W
Duy Tipi	E14
Koli	10
Fiyat	<b>25.00 TL</b>

## Anamur - Tekli



3203

Kod	22 02 10
Renk	Mat Krom
Güç	1x60W
Duy Tipi	E14
Koli	16
Fiyat	<b>22.00 TL</b>

## Anamur - ikili



3204

Kod	22 03 10
Renk	Mat Krom
Güç	2x60W
Duy Tipi	E14
Koli	12
Fiyat	<b>53.00 TL</b>

## Anamur - Üçlü



3205

Kod	22 04 10
Renk	Mat Krom
Güç	3x60W
Duy Tipi	E14
Koli	8
Fiyat	<b>76.00 TL</b>

## Anamur - Dörtlü



3206

Kod	22 05 10
Renk	Mat Krom
Güç	4x60W
Duy Tipi	E14
Koli	6
Fiyat	<b>104.00 TL</b>

## Karia - K60



3207

Kod	40 01 10
Renk	Mat Krom
Güç	1x20W
Duy Tipi	G 5.3
Koli	50
Fiyat	<b>16.00 TL</b>

## Karia - KY50



3208

Kod	40 02 10
Renk	Mat Krom
Güç	1x40W
Duy Tipi	G9
Koli	80
Fiyat	<b>20.00 TL</b>

## Karia - KK50



3209

Kod	40 03 10
Renk	Mat Krom
Güç	1x40W
Duy Tipi	G9
Koli	40
Fiyat	<b>23.00 TL</b>

## Karia - K300



3210

Kod	40 04 10
Renk	Mat Krom
Güç	2x40W
Duy Tipi	G9
Koli	30
Fiyat	<b>54.00 TL</b>

## Karia - YB280



3211

Kod	40 05 10
Renk	Mat Krom
Güç	2x40W
Duy Tipi	G9
Koli	20
Fiyat	<b>55.00 TL</b>

## Karia - YK280



3212

Kod	40 05 11
Renk	Mat Krom
Güç	2x40W
Duy Tipi	G9
Koli	20
Fiyat	<b>52.00 TL</b>

Duvar Aplikleri



Karia - YB100



3301

Kod	40 06 10
Renk	Mat Krom
Güç	1x40W
Duy Tipi	G9
Koli	40
Fiyat	<b>28.00 TL</b>

Karia - YK100



3302

Kod	40 06 11
Renk	Mat Krom
Güç	1x40W
Duy Tipi	G9
Koli	40
Fiyat	<b>22.00 TL</b>

Karia - YL180



3303

Kod	40 07 10
Renk	Mat Krom
Güç	1x40W
Duy Tipi	G9
Koli	60
Fiyat	<b>15.00 TL</b>

Karia - YB260



3304

Kod	40 08 10
Renk	Mat Krom
Güç	2x40W
Duy Tipi	G9
Koli	40
Fiyat	<b>33.00 TL</b>

Karia - YK260



3305

Kod	40 08 11
Renk	Mat Krom
Güç	2x40W
Duy Tipi	G9
Koli	40
Fiyat	<b>28.00 TL</b>

Karia - YB55



3306

Kod	40 09 10
Renk	Mat Krom
Güç	1x40W
Duy Tipi	G9
Koli	50
Fiyat	<b>21.00 TL</b>

Karia - YK55



3307

Kod	40 09 11
Renk	Mat Krom
Güç	1x40W
Duy Tipi	G9
Koli	50
Fiyat	<b>20.00 TL</b>

Karia - YK125



3308

Kod	40 10 10
Renk	Mat Krom
Güç	1x40W
Duy Tipi	G9
Koli	50
Fiyat	<b>25.00 TL</b>

Karia - YS125



3309

Kod	40 10 11
Renk	Mat Krom
Güç	1x40W
Duy Tipi	G9
Koli	50
Fiyat	<b>24.00 TL</b>

Karia - Y200



3310

Kod	40 11 10
Renk	Mat Krom
Güç	1x20W
Duy Tipi	G4
Koli	40
Fiyat	<b>20.00 TL</b>

Karia - D400



3111

Kod	40 12 10
Renk	Mat Krom
Güç	2x20W
Duy Tipi	G4
Koli	24
Fiyat	<b>31.00 TL</b>



## Side 300 Sensörlü



3401

Kod	11 05 90
Renk	Keten
Güç	2x60W
Duy Tipi	E27
Koli	12
Fiyat	<b>42.00 TL</b>

## Side 300 Sensörlü



3402

Kod	11 05 91
Renk	Kaptan
Güç	2x60W
Duy Tipi	E27
Koli	12
Fiyat	<b>42.00 TL</b>

## Side 300 Sensörlü



3403

Kod	11 05 92
Renk	Güneş
Güç	2x60W
Duy Tipi	E27
Koli	12
Fiyat	<b>42.00 TL</b>

## Lydia Aplik Sensörlü



3404

Kod	20 15 90
Renk	Keten
Güç	1x60W
Duy Tipi	E27
Koli	16
Fiyat	<b>43.00 TL</b>

## Lydia Aplik Sensörlü



3405

Kod	20 15 91
Renk	Line
Güç	1x60W
Duy Tipi	E27
Koli	16
Fiyat	<b>43.00 TL</b>

## Lydia Aplik Sensörlü



3406

Kod	20 15 92
Renk	Prizma
Güç	1x60W
Duy Tipi	E27
Koli	16
Fiyat	<b>43.00 TL</b>

## Lydia Aplik Sensörlü



3407

Kod	20 15 93
Renk	Rubik
Güç	1x60W
Duy Tipi	E27
Koli	16
Fiyat	<b>43.00 TL</b>

## Lydia Aplik Sensörlü



3408

Kod	20 15 94
Renk	Afacan
Güç	1x60W
Duy Tipi	E27
Koli	16
Fiyat	<b>43.00 TL</b>

## Lydia Aplik Sensörlü



3409

Kod	20 15 95
Renk	Snowman
Güç	1x60W
Duy Tipi	E27
Koli	16
Fiyat	<b>43.00 TL</b>

## Dekoratif Tavan Armatürleri



Galata 250



3501

Kod	10 29 10
Renk	Beyaz
Güç	1x60W
Duy Tipi	E27
Koli	20
Fiyat	<b>25.00 TL</b>

Galata 300



3502

Kod	10 30 10
Renk	Beyaz
Güç	2x60W
Duy Tipi	E27
Koli	16
Fiyat	<b>33.00 TL</b>

Saray 230



3503

Kod	10 35 83
Renk	Beyaz
Güç	2x60W
Duy Tipi	E27
Koli	8
Fiyat	<b>37.00 TL</b>

Saray 285



3504

Kod	10 36 83
Renk	Beyaz
Güç	2x60W
Duy Tipi	E27
Koli	8
Fiyat	<b>51.00 TL</b>

Hera 300



3505

Kod	10 31 83
Renk	Mat Krom
Güç	Max. 13W
Duy Tipi	2xE27
Koli	8
Fiyat	<b>73.00 TL</b>

Hera 300



3506

Kod	10 32 83
Renk	Mat Krom
Güç	Max. 13W
Duy Tipi	2xE27
Koli	8
Fiyat	<b>77.00 TL</b>

Hera DA



3507

Kod	10 33 83
Renk	Mat Krom
Güç	Max.60W
Duy Tipi	E27
Koli	8
Fiyat	<b>32.00 TL</b>

Hera DB



3508

Kod	10 34 83
Renk	Mat Krom
Güç	Max.60W
Duy Tipi	E27
Koli	8
Fiyat	<b>32.00 TL</b>

Tarabya 290



3509

Kod	20 04 90
Renk	Şeffaf
Güç	1x60W
Duy Tipi	E14
Koli	12
Fiyat	<b>21.00 TL</b>

Tarabya 290



3510

Kod	20 04 91
Renk	Oranj
Güç	1x60W
Duy Tipi	E14
Koli	12
Fiyat	<b>25.50 TL</b>

Tarabya 290



3511

Kod	20 04 92
Renk	Yeşil
Güç	1x60W
Duy Tipi	E14
Koli	12
Fiyat	<b>25.50 TL</b>

Tarabya 290



3512

Kod	20 04 93
Renk	Mavi
Güç	1x60W
Duy Tipi	E14
Koli	12
Fiyat	<b>25.50 TL</b>



## Tarabya 340



3601

Kod	20 05 90
Renk	Şeffaf
Güç	2x60W
Duy Tipi	E14
Koli	10
Fiyat	<b>25.00 TL</b>

## Tarabya 340



3602

Kod	20 05 91
Renk	Oranj
Güç	2x60W
Duy Tipi	E14
Koli	10
Fiyat	<b>30.50 TL</b>

## Tarabya 340



3603

Kod	20 05 92
Renk	Yeşil
Güç	2x60W
Duy Tipi	E14
Koli	10
Fiyat	<b>30.50 TL</b>

## Tarabya 340



3604

Kod	20 05 93
Renk	Mavi
Güç	2x60W
Duy Tipi	E14
Koli	10
Fiyat	<b>30.50 TL</b>

## Beyazıt 330



3605

Kod	20 06 90
Renk	Şeffaf
Güç	1x60W
Duy Tipi	E27
Koli	10
Fiyat	<b>32.50 TL</b>

## Beyazıt 330



3606

Kod	20 06 91
Renk	Oranj
Güç	1x60W
Duy Tipi	E27
Koli	10
Fiyat	<b>37.50 TL</b>

## Beyazıt 330



3607

Kod	20 06 92
Renk	Yeşil
Güç	1x60W
Duy Tipi	E27
Koli	10
Fiyat	<b>37.50 TL</b>

## Beyazıt 330

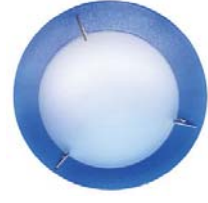

3608

Kod	20 06 93
Renk	Mavi
Güç	1x60W
Duy Tipi	E27
Koli	10
Fiyat	<b>37.50 TL</b>

## Simena 300



3609

Kod	20 16 90
Renk	Keten
Güç	2x60W
Duy Tipi	E27
Koli	12
Fiyat	<b>22.00 TL</b>

## Simena 300



3610

Kod	20 16 91
Renk	Line
Güç	2x60W
Duy Tipi	E27
Koli	12
Fiyat	<b>22.00 TL</b>

## Simena 300



3611

Kod	20 16 92
Renk	Prizma
Güç	2x60W
Duy Tipi	E27
Koli	12
Fiyat	<b>22.00 TL</b>

## Simena 300



3612

Kod	20 16 93
Renk	Rubik
Güç	2x60W
Duy Tipi	E27
Koli	12
Fiyat	<b>22.00 TL</b>

Dekoratif Tavan Armatürleri



**Simena 300**



3701

Kod	20 16 94
Renk	Afacan
Güç	2x60W
Duy Tipi	E27
Koli	12
Fiyat	<b>22.00 TL</b>

**Simena 300**



3702

Kod	20 16 95
Renk	Snowman
Güç	2x60W
Duy Tipi	E27
Koli	12
Fiyat	<b>22.00 TL</b>

**Simena 400**



3703

Kod	20 17 90
Renk	Keten
Güç	3x60W
Duy Tipi	E27
Koli	6
Fiyat	<b>31.00 TL</b>

**Simena 400**



3704

Kod	20 17 91
Renk	Line
Güç	3x60W
Duy Tipi	E27
Koli	6
Fiyat	<b>31.00 TL</b>

**Simena 400**



3705

Kod	20 17 92
Renk	Prizma
Güç	3x60W
Duy Tipi	E27
Koli	6
Fiyat	<b>31.00 TL</b>

**Simena 400**



3706

Kod	20 17 93
Renk	Rubik
Güç	3x60W
Duy Tipi	E27
Koli	6
Fiyat	<b>31.00 TL</b>

**Kelebek - S**



3707

Kod	30 01 22
Renk	Pembe
Güç	1x60W
Duy Tipi	E14
Koli	10
Fiyat	<b>56.00 TL</b>

**Flipper - S**



3708

Kod	30 01 30
Renk	Mavi
Güç	1x60W
Duy Tipi	E14
Koli	10
Fiyat	<b>56.00 TL</b>

**Canary - S**



3709

Kod	30 01 60
Renk	Sarı
Güç	1x60W
Duy Tipi	E14
Koli	10
Fiyat	<b>56.00 TL</b>

Alanya - s



3801

Kod	21 35 12
Renk	Opal
Güç	1x60W
Duy Tipi	E27
Koli	8
Fiyat	<b>52.00 TL</b>

Fethiye - s



3802

Kod	21 45 12
Renk	Opal
Güç	1x60W
Duy Tipi	E27
Koli	12
Fiyat	<b>40.00 TL</b>

Fethiye - 3S Round



3803

Kod	21 48 12
Renk	Opal
Güç	3x60W
Duy Tipi	E27
Koli	4
Fiyat	<b>110.00 TL</b>

Finike - S250



3804

Kod	21 55 12
Renk	Opal
Güç	1x60W
Duy Tipi	E27
Koli	8
Fiyat	<b>55.00 TL</b>

Finike - S350



3805

Kod	21 56 12
Renk	Opal
Güç	2x60W
Duy Tipi	E27
Koli	2
Fiyat	<b>99.00 TL</b>

Side - s 300



3806

Kod	11 13 70
Renk	Keten
Güç	1x60W
Duy Tipi	E27
Koli	12
Fiyat	<b>15.50 TL</b>

Side - s 300



3807

Kod	11 13 71
Renk	Kaptan
Güç	1x60W
Duy Tipi	E27
Koli	12
Fiyat	<b>15.50 TL</b>

Side - s 300



3808

Kod	11 13 72
Renk	Güneş
Güç	1x60W
Duy Tipi	E27
Koli	12
Fiyat	<b>15.50 TL</b>

Simena - S 400



3809

Kod	20 18 90
Renk	Keten
Güç	1x60W
Duy Tipi	E27
Koli	6
Fiyat	<b>48.00 TL</b>

Simena - S 400



3810

Kod	20 18 91
Renk	Line
Güç	1x60W
Duy Tipi	E27
Koli	6
Fiyat	<b>48.00 TL</b>

Simena - S 400



3811

Kod	20 18 92
Renk	Prizma
Güç	1x60W
Duy Tipi	E27
Koli	6
Fiyat	<b>48.00 TL</b>

Simena - S 400



3812

Kod	20 18 93
Renk	Rubik
Güç	1x60W
Duy Tipi	E27
Koli	6
Fiyat	<b>48.00 TL</b>

## Sarkıtlar



## Simena - s 400



3901

Kod	20 18 94
Renk	Keten
Güç	3x60W
Duy Tipi	E27
Koli	6
Fiyat	<b>62.00 TL</b>

## Simena - s 400



3902

Kod	20 18 95
Renk	Line
Güç	3x60W
Duy Tipi	E27
Koli	6
Fiyat	<b>62.00 TL</b>

## Simena - s 400



3903

Kod	20 18 96
Renk	Prizma
Güç	3x60W
Duy Tipi	E27
Koli	6
Fiyat	<b>62.00 TL</b>

## Simena - s 400



3904

Kod	20 18 97
Renk	Rubik
Güç	3x60W
Duy Tipi	E27
Koli	6
Fiyat	<b>62.00 TL</b>

## Truva 500



3905

Kod	20 19 90
Renk	Flat
Güç	1x60W
Duy Tipi	E27
Koli	5
Fiyat	<b>55.00 TL</b>

## Truva - s 500



3906

Kod	20 19 91
Renk	Deep
Güç	1x60W
Duy Tipi	E27
Koli	5
Fiyat	<b>55.00 TL</b>

## Truva - s 500



3907

Kod	20 19 92
Renk	Teos
Güç	1x60W
Duy Tipi	E27
Koli	5
Fiyat	<b>55.00 TL</b>

## Truva - s 500



3908

Kod	20 19 93
Renk	Flat
Güç	3x60W
Duy Tipi	E27
Koli	5
Fiyat	<b>70.00 TL</b>

## Truva - s 500



3909

Kod	20 19 94
Renk	Deep
Güç	3x60W
Duy Tipi	E27
Koli	5
Fiyat	<b>70.00 TL</b>

## Truva - s 500



3910

Kod	20 19 95
Renk	Teos
Güç	3x60W
Duy Tipi	E27
Koli	5
Fiyat	<b>70.00 TL</b>

## Efes - s 270



3911

Kod	20 20 90
Renk	Keten
Güç	1x60W
Duy Tipi	E27
Koli	8
Fiyat	<b>29.00 TL</b>

## Efes - s 270



3912

Kod	20 20 91
Renk	Lens
Güç	1x60W
Duy Tipi	E27
Koli	8
Fiyat	<b>29.00 TL</b>





Sarkıtlar

**Efes - s 270**



4001

Kod	20 20 92
Renk	Civciv
Güç	1x60W
Duy Tipi	E27
Koli	8
Fiyat	<b>29.00 TL</b>

**Efes - s 270**



4002

Kod	20 20 93
Renk	Moon
Güç	1x60W
Duy Tipi	E27
Koli	8
Fiyat	<b>29.00 TL</b>

**Efes - s 270**



4003

Kod	20 20 94
Renk	Gool
Güç	1x60W
Duy Tipi	E27
Koli	8
Fiyat	<b>29.00 TL</b>

**Efes - s 380**



4004

Kod	20 21 90
Renk	Keten
Güç	1x60W
Duy Tipi	E27
Koli	8
Fiyat	<b>39.50 TL</b>

**Efes-S 380**



4005

Kod	20 21 91
Renk	Lens
Güç	1x60W
Duy Tipi	E27
Koli	4
Fiyat	<b>39.50 TL</b>

**Efes - ST 380**



4006

Kod	20 21 92
Renk	Keten
Güç	1x60W
Duy Tipi	E27
Koli	4
Fiyat	<b>44.00 TL</b>

**Efes - ST 380**



4007

Kod	20 21 93
Renk	Lens
Güç	1x60W
Duy Tipi	E27
Koli	4
Fiyat	<b>44.00 TL</b>

**Dicle - s 135**



4008

Kod	21 01 10
Renk	Alabastra
Güç	1x60W
Duy Tipi	E27
Koli	24
Fiyat	<b>23.00 TL</b>

**Dicle - s 135**



4009

Kod	21 01 12
Renk	Opal
Güç	1x60W
Duy Tipi	E27
Koli	24
Fiyat	<b>23.00 TL</b>

**Dicle - s 135**



4010

Kod	21 01 43
Renk	Antik
Güç	1x60W
Duy Tipi	E27
Koli	24
Fiyat	<b>23.00 TL</b>

**Dicle - s 135**



4011

Kod	21 01 62
Renk	Ananas
Güç	1x60W
Duy Tipi	E27
Koli	24
Fiyat	<b>23.00 TL</b>

**Dicle - s 250**



4012

Kod	21 02 10
Renk	Alabastra
Güç	1x60W
Duy Tipi	E27
Koli	12
Fiyat	<b>33.00 TL</b>

## Sarkıtlar



**Dicle - s 250**



4101

Kod	21 02 12
Renk	Opal
Güç	1x60W
Duy Tipi	E27
Koli	12
Fiyat	<b>33.00 TL</b>

**Dicle - s 250**



4102

Kod	21 02 43
Renk	Antik
Güç	1x60W
Duy Tipi	E27
Koli	12
Fiyat	<b>33.00 TL</b>

**Dicle - s 250**



4103

Kod	21 02 62
Renk	Ananas
Güç	1x60W
Duy Tipi	E27
Koli	12
Fiyat	<b>33.00 TL</b>

**Dicle - s 330**



4104

Kod	21 03 10
Renk	Alabastra
Güç	1x60W
Duy Tipi	E27
Koli	8
Fiyat	<b>40.00 TL</b>

**Dicle - s 330**



4105

Kod	21 03 12
Renk	Opal
Güç	1x60W
Duy Tipi	E27
Koli	8
Fiyat	<b>40.00 TL</b>

**Dicle - s 330**



4106

Kod	21 03 43
Renk	Antik
Güç	1x60W
Duy Tipi	E27
Koli	8
Fiyat	<b>40.00 TL</b>

**Dicle - s 330**



4107

Kod	21 03 62
Renk	Ananas
Güç	1x60W
Duy Tipi	E27
Koli	8
Fiyat	<b>40.00 TL</b>

**Dicle - 3S Round**



4108

Kod	21 04 10
Renk	Alabastra
Güç	3x60W
Duy Tipi	E27
Koli	12
Fiyat	<b>62.00 TL</b>

**Dicle - 3S Round**



4109

Kod	21 04 12
Renk	Opal
Güç	3x60W
Duy Tipi	E27
Koli	12
Fiyat	<b>62.00 TL</b>

**Dicle - 3S Round**



4110

Kod	21 04 43
Renk	Antik
Güç	3x60W
Duy Tipi	E27
Koli	12
Fiyat	<b>62.00 TL</b>

**Dicle - 3S Round**



4111

Kod	21 04 62
Renk	Ananas
Güç	3x60W
Duy Tipi	E27
Koli	12
Fiyat	<b>62.00 TL</b>

**Dicle - 2S Flat**



4112

Kod	21 05 10
Renk	Alabastra
Güç	2x60W
Duy Tipi	E27
Koli	12
Fiyat	<b>39.00 TL</b>



Sarkıtlar

**Dicle - 2S Flat**



4201

Kod	21 05 12
Renk	Opal
Güç	2x60W
Duy Tipi	E27
Koli	12
Fiyat	<b>39.00 TL</b>

**Dicle - 2S Flat**



4202

Kod	21 05 43
Renk	Antik
Güç	2x60W
Duy Tipi	E27
Koli	12
Fiyat	<b>39.00 TL</b>

**Dicle - 2S Flat**



4203

Kod	21 05 62
Renk	Ananas
Güç	2x60W
Duy Tipi	E27
Koli	12
Fiyat	<b>39.00 TL</b>

**Dicle - 3S Flat**



4204

Kod	21 06 10
Renk	Alabastra
Güç	3x60W
Duy Tipi	E27
Koli	6
Fiyat	<b>59.00 TL</b>

**Dicle - 3S Flat**



4205

Kod	21 06 12
Renk	Opal
Güç	3x60W
Duy Tipi	E27
Koli	6
Fiyat	<b>59.00 TL</b>

**Dicle - 3S Flat**



4206

Kod	21 06 43
Renk	Antik
Güç	3x60W
Duy Tipi	E27
Koli	6
Fiyat	<b>59.00 TL</b>

**Dicle - 3S Flat**



4207

Kod	21 06 62
Renk	Ananas
Güç	3x60W
Duy Tipi	E27
Koli	6
Fiyat	<b>59.00 TL</b>

**Fırat - s 130**



4208

Kod	21 15 10
Renk	Alabastra
Güç	1x60W
Duy Tipi	E27
Koli	24
Fiyat	<b>23.00 TL</b>

**Fırat - s 130**



4209

Kod	21 15 12
Renk	Opal
Güç	1x60W
Duy Tipi	E27
Koli	24
Fiyat	<b>23.00 TL</b>

**Fırat - s 130**



4210

Kod	21 15 43
Renk	Antik
Güç	1x60W
Duy Tipi	E27
Koli	24
Fiyat	<b>23.00 TL</b>

**Fırat - s 130**



4211

Kod	21 15 62
Renk	Ananas
Güç	1x60W
Duy Tipi	E27
Koli	24
Fiyat	<b>23.00 TL</b>

**Fırat - s 190**



4212

Kod	21 16 10
Renk	Alabastra
Güç	1x60W
Duy Tipi	E27
Koli	12
Fiyat	<b>33.00 TL</b>

## Sarkıtlar



Fırat - s 190



4301

Kod	21 16 12
Renk	Opal
Güç	1x60W
Duy Tipi	E27
Koli	12
Fiyat	<b>33.00 TL</b>

Fırat - s 190



4302

Kod	21 16 43
Renk	Antik
Güç	1x60W
Duy Tipi	E27
Koli	12
Fiyat	<b>33.00 TL</b>

Fırat - s 190



4303

Kod	21 16 62
Renk	Ananas
Güç	1x60W
Duy Tipi	E27
Koli	12
Fiyat	<b>33.00 TL</b>

Fırat - s 260



4304

Kod	21 17 10
Renk	Alabastra
Güç	1x60W
Duy Tipi	E27
Koli	8
Fiyat	<b>40.00 TL</b>

Fırat - s 260



4305

Kod	21 17 12
Renk	Opal
Güç	1x60W
Duy Tipi	E27
Koli	8
Fiyat	<b>40.00 TL</b>

Fırat - s 260



4306

Kod	21 17 43
Renk	Antik
Güç	1x60W
Duy Tipi	E27
Koli	8
Fiyat	<b>40.00 TL</b>

Fırat - s 260



4307

Kod	21 17 62
Renk	Ananas
Güç	1x60W
Duy Tipi	E27
Koli	8
Fiyat	<b>40.00 TL</b>

Fırat - 3S Round



4308

Kod	21 18 10
Renk	Alabastra
Güç	3x60W
Duy Tipi	E27
Koli	8
Fiyat	<b>62.00 TL</b>

Fırat - 3S Round



4309

Kod	21 18 12
Renk	Opal
Güç	3x60W
Duy Tipi	E27
Koli	8
Fiyat	<b>62.00 TL</b>

Fırat - 3S Round



4310

Kod	21 18 43
Renk	Antik
Güç	3x60W
Duy Tipi	E27
Koli	8
Fiyat	<b>62.00 TL</b>

Fırat - 3S Round



4311

Kod	21 18 62
Renk	Ananas
Güç	3x60W
Duy Tipi	E27
Koli	8
Fiyat	<b>62.00 TL</b>

Fırat - 2S Flat



4312

Kod	21 19 10
Renk	Alabastra
Güç	2x60W
Duy Tipi	E27
Koli	12
Fiyat	<b>39.00 TL</b>



Fırat - 2S Flat



4401

Kod	21 19 12
Renk	Opal
Güç	2x60W
Duy Tipi	E27
Koli	12
Fiyat	<b>39.00 TL</b>

Fırat - 2S Flat



4402

Kod	21 19 43
Renk	Antik
Güç	2x60W
Duy Tipi	E27
Koli	12
Fiyat	<b>39.00 TL</b>

Fırat - 2S Flat



4403

Kod	21 19 62
Renk	Ananas
Güç	2x60W
Duy Tipi	E27
Koli	12
Fiyat	<b>39.00 TL</b>

Fırat - 3S Flat



4404

Kod	21 20 10
Renk	Alabastra
Güç	3x60W
Duy Tipi	E27
Koli	6
Fiyat	<b>59.00 TL</b>

Fırat - 3S Flat



4405

Kod	21 20 12
Renk	Opal
Güç	3x60W
Duy Tipi	E27
Koli	6
Fiyat	<b>59.00 TL</b>

Fırat - 3S Flat



4406

Kod	21 20 43
Renk	Antik
Güç	3x60W
Duy Tipi	E27
Koli	6
Fiyat	<b>59.00 TL</b>

Fırat - 3S Flat



4407

Kod	21 20 62
Renk	Ananas
Güç	3x60W
Duy Tipi	E27
Koli	6
Fiyat	<b>59.00 TL</b>

Toros - S



4408

Kod	21 25 11
Renk	Split
Güç	1x60W
Duy Tipi	E27
Koli	12
Fiyat	<b>40.00 TL</b>

Toros - S



4409

Kod	21 25 12
Renk	Opal
Güç	1x60W
Duy Tipi	E27
Koli	12
Fiyat	<b>39.00 TL</b>

Toros - S



4410

Kod	21 25 13
Renk	Alaca
Güç	1x60W
Duy Tipi	E27
Koli	12
Fiyat	<b>44.00 TL</b>

Toros - S



4411

Kod	21 25 62
Renk	Ananas
Güç	1x60W
Duy Tipi	E27
Koli	12
Fiyat	<b>39.00 TL</b>

Toros - 3S Round



4412

Kod	21 26 11
Renk	Split
Güç	3x60W
Duy Tipi	E27
Koli	4
Fiyat	<b>99.00 TL</b>

## Sarkıtlar



## Toros - 3S Round



4501

Kod	21 26 12
Renk	Opal
Güç	3x60W
Duy Tipi	E27
Koli	4
Fiyat	<b>96.00 TL</b>

## Toros - 3S Round



4502

Kod	21 26 13
Renk	Alaca
Güç	3x60W
Duy Tipi	E27
Koli	4
Fiyat	<b>116.00 TL</b>

## Toros - 3S Round



4503

Kod	21 26 62
Renk	Ananas
Güç	3x60W
Duy Tipi	E27
Koli	4
Fiyat	<b>96.00 TL</b>

## Toros - 2S Flat



4504

Kod	21 27 11
Renk	Split
Güç	2x60W
Duy Tipi	E27
Koli	6
Fiyat	<b>69.00 TL</b>

## Toros - 2S Flat



4505

Kod	21 27 12
Renk	Opal
Güç	2x60W
Duy Tipi	E27
Koli	6
Fiyat	<b>68.00 TL</b>

## Toros - 2S Flat



4506

Kod	21 27 13
Renk	Alaca
Güç	2x60W
Duy Tipi	E27
Koli	6
Fiyat	<b>84.00 TL</b>

## Toros - 2S Flat



4507

Kod	21 27 62
Renk	Ananas
Güç	2x60W
Duy Tipi	E27
Koli	6
Fiyat	<b>68.00 TL</b>

## Toros - 3S Flat



4508

Kod	21 28 11
Renk	Split
Güç	3x60W
Duy Tipi	E27
Koli	6
Fiyat	<b>100.00 TL</b>

## Toros - 3S Flat



4509

Kod	21 28 12
Renk	Opal
Güç	3x60W
Duy Tipi	E27
Koli	6
Fiyat	<b>98.00 TL</b>

## Toros - 3S Flat



4510

Kod	21 28 13
Renk	Alaca
Güç	3x60W
Duy Tipi	E27
Koli	6
Fiyat	<b>117.00 TL</b>

## Toros - 3S Flat



4511

Kod	21 28 62
Renk	Ananas
Güç	3x60W
Duy Tipi	E27
Koli	6
Fiyat	<b>98.00 TL</b>

Yeni



Finike-S 350

Aydınlatmayı estetikle  
buluşturan çizgi



Fethiye-S



Alanya-S



Finike-S 250



Fethiye-S round

**vit**orain<sup>®</sup>

Projektörler



Projektör



4701

Kod	<b>VT362</b>
Renk	Siyah
Güç	150W
Duy Tipi	R7S-78mm
Kutu/Koli	1/30
Fiyat (USD)	<b>5.80</b>

Projektör



4702

Kod	<b>VT364</b>
Renk	Siyah
Güç	500W
Duy Tipi	R7S-118mm
Kutu/Koli	1/20
Fiyat (USD)	<b>8.50</b>

Projektör



4703

Kod	<b>VT366</b>
Renk	Siyah
Güç	1000W
Duy Tipi	R7S-189mm
Kutu/Koli	1/6
Fiyat (USD)	<b>17.70</b>

Sensörlü-Kafesli



4704

Kod	<b>VT370</b>
Renk	Siyah
Güç	150W
Duy Tipi	R7S-78mm
Kutu/Koli	1/20
Fiyat (USD)	<b>18.20</b>

Sensörlü-Kafesli



4705

Kod	<b>VT372</b>
Renk	Siyah
Güç	500W
Duy Tipi	R7S-118mm
Kutu/Koli	1/10
Fiyat (USD)	<b>21.00</b>

Ateşleme Sistemli



4706

Kod	<b>VT375</b>
Renk	Siyah
Güç	150W
Duy Tipi	R7S-78mm
Kutu/Koli	1/4
Fiyat (USD)	<b>54.00</b>

Ateşleme Sistemli



4707

Kod	<b>VT373R</b>
Renk	Gri
Güç	150W
Duy Tipi	R7S-78mm
Kutu/Koli	1/4
Fiyat (USD)	<b>72.00</b>

Ateşleme Sistemli



4708

Kod	<b>VT377</b>
Renk	Gri
Güç	150W
Duy Tipi	R7S
Kutu/Koli	1/4
Fiyat (USD)	<b>72.00</b>

Ateşleme Sistemli



4709

Kod	<b>VT374</b>
Renk	Siyah
Güç	400W
Duy Tipi	E40
Kutu/Koli	1/1
Fiyat (USD)	<b>74.00</b>

Ateşleme Sistemli



4710

Kod	<b>VT378</b>
Renk	Siyah
Güç	400W
Duy Tipi	E40
Kutu/Koli	1/1
Fiyat (USD)	<b>139.00</b>

Asimetrik





## Ayna ve Resim Aydınlatma Armatürleri



Dahili Elektronik Trafo

	Kod	Renk	Güç	Duy Tipi	Koli	Fiyat (USD)
4801	<b>VT880</b>	Krom	2x20W	G4	1/20	<b>26.50</b>
4802	<b>VT880</b>	Altın	2x20W	G4	1/20	<b>26.50</b>
4803	<b>VT880</b>	Mat Krom	2x20W	G4	1/20	<b>26.50</b>
4804	<b>VT880</b>	Parlak Siyah	2x20W	G4	1/20	<b>26.50</b>

## Ayna ve Resim Aydınlatma Armatürleri



	Kod	Renk	Güç	Duy Tipi	Koli	Fiyat (USD)
4805	<b>VT881</b>	Krom	2x20W	E14	1/20	<b>28.50</b>
4806	<b>VT881</b>	Altın	2x20W	E14	1/20	<b>28.50</b>
4807	<b>VT881</b>	Mat Krom	2x20W	E14	1/20	<b>28.50</b>
4808	<b>VT881</b>	Parlak Siyah	2x20W	E14	1/20	<b>28.50</b>

## Ayna ve Resim Aydınlatma Armatürleri



Dahili Elektronik Ballast

	Kod	Renk	Güç	Duy Tipi	Koli	Fiyat (USD)
4809	<b>VT882</b>	Krom	8W	T4	1/20	<b>25.50</b>
4810	<b>VT882</b>	Altın	8W	T4	1/20	<b>25.50</b>
4811	<b>VT882</b>	Mat Krom	8W	T4	1/20	<b>25.50</b>
4812	<b>VT882</b>	Parlak Siyah	8W	T4	1/20	<b>25.50</b>
4813	<b>VT882</b>	Mat Altın	8W	T4	1/20	<b>25.50</b>

## Ayna ve Resim Aydınlatma Armatürleri



	Kod	Renk	Güç	Duy Tipi	Koli	Fiyat (USD)
4814	<b>VT883</b>	Krom	2x25W	G9	1/12	<b>21.50</b>
4815	<b>VT883</b>	Altın	2x25W	G9	1/12	<b>21.50</b>
4816	<b>VT883</b>	Mat Krom	2x25W	G9	1/12	<b>21.50</b>
4817	<b>VT883</b>	Mat Altın	2x25W	G9	1/12	<b>21.50</b>

## Spot Armatürler



## Spot Armatürler

Kod	Renk	Güç	Duy Tipi	Koli	Fiyat (USD)	
4901	<b>VT900</b>	Beyaz	40W	E14	1/30	<b>4.80</b>
4902	<b>VT901</b>	Siyah	40W	E14	1/30	<b>4.80</b>
4903	<b>VT902</b>	Altın	40W	E14	1/30	<b>5.70</b>
4904	<b>VT903</b>	Krom	40W	E14	1/30	<b>5.70</b>
4905	<b>VT903M</b>	Mat Krom	40W	E14	1/30	<b>6.00</b>

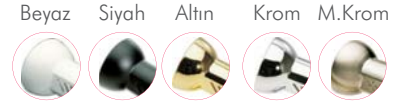

## Spot Armatürler

Kod	Renk	Güç	Duy Tipi	Koli	Fiyat (USD)	
4906	<b>VT904</b>	Beyaz	60W	E27	1/30	<b>6.80</b>
4907	<b>VT905</b>	Siyah	60W	E27	1/30	<b>6.80</b>
4908	<b>VT906</b>	Altın	60W	E27	1/30	<b>9.00</b>
4909	<b>VT907</b>	Krom	60W	E27	1/30	<b>9.00</b>
4910	<b>VT907M</b>	Mat Krom	60W	E27	1/30	<b>9.50</b>

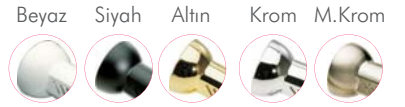

## Spot Armatürler

Kod	Renk	Güç	Duy Tipi	Koli	Fiyat (USD)	
4911	<b>VT912</b>	Beyaz	60W	E27	1/30	<b>7.10</b>
4912	<b>VT913</b>	Siyah	60W	E27	1/30	<b>7.10</b>
4913	<b>VT914</b>	Altın	60W	E27	1/30	<b>9.60</b>
4914	<b>VT915</b>	Krom	60W	E27	1/30	<b>9.60</b>
4915	<b>VT915M</b>	Mat Krom	60W	E27	1/30	<b>9.70</b>

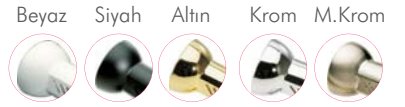

Anahtarlı

## Spot Armatürler

Kod	Renk	Güç	Duy Tipi	Koli	Fiyat (USD)	
4916	<b>VT922</b>	Beyaz	3x40W	E14	1/12	<b>18.90</b>
4917	<b>VT923</b>	Krom	3x40W	E14	1/12	<b>22.80</b>
4918	<b>VT923M</b>	Mat Krom	3x40W	E14	1/12	<b>23.30</b>
4919	<b>VT926</b>	Beyaz	2x60W	E27	1/12	<b>15.50</b>
4920	<b>VT927</b>	Krom	2x60W	E27	1/12	<b>20.50</b>
4921	<b>VT927M</b>	Mat Krom	2x60W	E27	1/12	<b>21.70</b>
4922	<b>VT930</b>	Beyaz	3x60W	E27	1/12	<b>19.90</b>
4923	<b>VT931</b>	Krom	3x60W	E27	1/12	<b>27.00</b>
4924	<b>VT931M</b>	Mat Krom	3x60W	E27	1/12	<b>29.00</b>

Beyaz Krom M.Krom





### VT410 Spot Armatür



5001

Renk	Gri
Güç	1x40W
Duy Tipi	E14
Kutu/Koli	1/30
Fiyat (USD)	<b>8.00</b>

### VT411 Spot Armatür



5002

Renk	Gri
Güç	2x40W
Duy Tipi	E14
Kutu/Koli	1/20
Fiyat (USD)	<b>20.40</b>

### VT412 Spot Armatür



5003

Renk	Gri
Güç	3x40W
Duy Tipi	E14
Kutu/Koli	1/20
Fiyat (USD)	<b>30.60</b>

### VT413 Spot Armatür



5004

Renk	Mat Krom
Güç	1x50W
Duy Tipi	GU10
Kutu/Koli	1/20
Fiyat (USD)	<b>6.80</b>

### VT414 Spot Armatür



5005

Renk	Mat Krom
Güç	2x50W
Duy Tipi	GU10
Kutu/Koli	1/30
Fiyat (USD)	<b>13.80</b>

### VT415 Spot Armatür



5006

Renk	Mat Krom
Güç	3x50W
Duy Tipi	GU10
Kutu/Koli	1/30
Fiyat (USD)	<b>21.60</b>

### VT441

#### Tavan Armatürü



5007

Renk	Gri
Güç	1x40W
Duy Tipi	G9
Kutu/Koli	1/24
Fiyat (USD)	<b>13.50</b>

### VT442

#### Tavan Armatürü



5008

Renk	Gri
Güç	2x40W
Duy Tipi	G9
Kutu/Koli	1/18
Fiyat (USD)	<b>25.90</b>

### VT443

#### Tavan Armatürü



5009

Renk	Gri
Güç	3x40W
Duy Tipi	G9
Kutu/Koli	1/12
Fiyat (USD)	<b>39.90</b>

### VT444

#### Tavan Armatürü



5010

Renk	Gri
Güç	4x40W
Duy Tipi	G9
Kutu/Koli	1/6
Fiyat (USD)	<b>59.90</b>

Spot Armatürler



VT541 Tavan Armatürü



5101

Renk	Krom,Mat Krom
Güç	40W
Duy Tipi	E14
Kutu/Koli	1/24
Fiyat (USD)	<b>11.90</b>

VT544 Tavan Armatürü



5102

Renk	Krom,Mat Krom
Güç	2x40W
Duy Tipi	E14
Kutu/Koli	1/12
Fiyat (USD)	<b>26.50</b>

VT545 Tavan Armatürü



5103

Renk	Krom,Mat Krom
Güç	3x40W
Duy Tipi	E14
Kutu/Koli	1/6
Fiyat (USD)	<b>39.70</b>

VT542 Tavan Armatürü



5104

Renk	Krom,Mat Krom
Güç	2x40W
Duy Tipi	E14
Kutu/Koli	1/6
Fiyat (USD)	<b>27.00</b>

VT543 Tavan Armatürü



5105

Renk	Krom,Mat Krom
Güç	3x40W
Duy Tipi	E14
Kutu/Koli	1/6
Fiyat (USD)	<b>39.70</b>

VT015 Tavan Armatürü



5106

Renk	Krom
Cam Rengi	Beyaz
Güç	50W
Duy Tipi	MR16
Kutu/Koli	1/50
Fiyat (USD)	<b>7.20</b>

VT521 Tavan Armatürü



5107

Renk	Mat Krom
Güç	50W
Duy Tipi	GU10
Kutu/Koli	1/24
Fiyat (USD)	<b>12.90</b>

VT522 Tavan Armatürü



5108

Renk	Mat Krom
Güç	2x50W
Duy Tipi	GU10
Kutu/Koli	1/12
Fiyat (USD)	<b>25.90</b>

VT523 Tavan Armatürü



5109

Renk	Mat Krom
Güç	3x50W
Duy Tipi	GU10
Kutu/Koli	1/12
Fiyat (USD)	<b>38.60</b>



## VT510

Masa Lambası Ampulsüz



5201

Renk	Mat Krom
Güç	1x40W
Duy Tipi	G9
Kutu/Koli	1/6
Fiyat (USD)	<b>23.30</b>

## VT511 Tavan Armatürü



5202

Renk	Mat Krom
Güç	1x40W
Duy Tipi	G9
Kutu/Koli	1/24
Fiyat (USD)	<b>12.60</b>

## VT512 Tavan Armatürü



5203

Renk	Mat Krom
Güç	2x40W
Duy Tipi	G9
Kutu/Koli	1/12
Fiyat (USD)	<b>25.80</b>

## VT513 Tavan Armatürü



5204

Renk	Mat Krom
Güç	3x40W
Duy Tipi	G9
Kutu/Koli	1/12
Fiyat (USD)	<b>38.40</b>

## VT514 Tavan Armatürü



5205

Renk	Mat Krom
Güç	4x40W
Duy Tipi	G9
Kutu/Koli	1/6
Fiyat (USD)	<b>51.00</b>

## VT515 Tavan Armatürü



5206

Renk	Mat Krom
Güç	3x40W
Duy Tipi	G9
Kutu/Koli	1/12
Fiyat (USD)	<b>38.80</b>

## VT516 Tavan Armatürü



5207

Renk	Mat Krom
Güç	4x40W
Duy Tipi	G9
Kutu/Koli	1/6
Fiyat (USD)	<b>51.00</b>

Spot Armatürler



VT524 Tavan Armatürü



5301

Renk	Mat Krom
Güç	4x50W
Duy Tipi	GU10
Kutu/Koli	1/6
Fiyat (USD)	<b>47.60</b>

VT525 Tavan Armatürü



5302

Renk	Mat Krom
Güç	4x50W
Duy Tipi	GU10
Kutu/Koli	1/6
Fiyat (USD)	<b>64.00</b>

VT528 Lambader



5305

Renk	Mat Krom
Güç	2x50W
Duy Tipi	GU10
Kutu/Koli	1/4
Fiyat (USD)	<b>66.00</b>

VT526 Tavan Armatürü



5303

Renk	Mat Krom
Güç	5x50W
Duy Tipi	GU10
Kutu/Koli	1/6
Fiyat (USD)	<b>78.70</b>

VT527 Masa Lambası



Ampulsuz

5304

Renk	Mat Krom
Güç	50W
Duy Tipi	GU10
Kutu/Koli	1/6
Fiyat (USD)	<b>20.70</b>

VT171 Pluton Spot



Şeffaf Camlı

5306

Renk	Aluminyum
Güç	Max. 20W
Duy Tipi	G4
Kutu/Koli	1/100
Fiyat (USD)	<b>6.40</b>

VT172 Pluton Spot



Şeffaf Camlı

5307

Renk	Aluminyum
Güç	Max. 20W
Duy Tipi	G4
Kutu/Koli	1/100
Fiyat (USD)	<b>7.00</b>

VT173 Pluton Spot



Şeffaf Camlı

5308

Renk	Aluminyum
Güç	Max. 20W
Duy Tipi	G4
Kutu/Koli	1/100
Fiyat (USD)	<b>6.80</b>



## VT190 Pluton Spot



5401

Renk	Gri
Güç	50W
Duy Tipi	G4
Kutu/Koli	1/50
Fiyat (USD)	<b>6.90</b>

## VT191 Pluton Spot



5402

Renk	Gri
Güç	50W
Duy Tipi	G4
Kutu/Koli	1/50
Fiyat (USD)	<b>6.90</b>

## VT192 Pluton Spot



5403

Renk	Gri
Güç	50W
Duy Tipi	G4
Kutu/Koli	1/50
Fiyat (USD)	<b>6.90</b>

## VT400 - Gümüs



5404

Renk	Gümüs
Güç	50W
Duy Tipi	MR16
Kutu/Koli	1/50
Fiyat (USD)	<b>12.70</b>

## VT400 - Beyaz



5405

Renk	Beyaz
Güç	50W
Duy Tipi	MR16
Kutu/Koli	1/50
Fiyat (USD)	<b>9.30</b>

## VT403

## Pluton Spot



5406

Renk	Mat Krom
Güç	20W
Duy Tipi	G4
Kutu/Koli	1/100
Fiyat (USD)	<b>6.00</b>

## VT426

## Pluton Spot



5407

Renk	Krom
Güç	50W
Duy Tipi	MR16
Kutu/Koli	1/100
Fiyat (USD)	<b>6.20</b>

## VT406 Pluton Spot



	Renk	Güç	Duy Tipi	Koli	Fiyat (USD)
5408	Krom	50W	MR16	1/50	<b>3.95</b>
5409	Mat Krom	50W	MR16	1/50	<b>3.95</b>
5410	Beyaz	50W	MR16	1/50	<b>3.20</b>

## VT422 Pluton Spot



	Renk	Güç	Duy Tipi	Koli	Fiyat (USD)
5411	Krom	50W	MR16	1/100	<b>2.70</b>
5412	Mat Krom	50W	MR16	1/100	<b>2.70</b>
5413	Beyaz	50W	MR16	1/100	<b>2.10</b>

Spot Armatürler



VT9221 Pluton Spot



	Renk	Güç	Duy Tipi	Koli	Fiyat (USD)
5501	Krom	20W	G4	1/500	<b>1.85</b>
5502	Mat Krom	20W	G4	1/500	<b>1.85</b>
5503	Beyaz	20W	G4	1/500	<b>1.75</b>

VT9232 Pluton Spot



	Renk	Güç	Duy Tipi	Koli	Fiyat (USD)
5504	Beyaz	20W	G4	1/100	<b>4.50</b>
5505	Krom	20W	G4	1/100	<b>4.50</b>

VT9242 Pluton Spot



	Renk	Güç	Duy Tipi	Koli	Fiyat (USD)
5506	Krom	20W	G4	1/200	<b>2.25</b>
5507	Mat Krom	20W	G4	1/200	<b>2.25</b>
5508	Beyaz	20W	G4	1/200	<b>1.85</b>

VT9251 Pluton Spot



	Renk	Güç	Duy Tipi	Koli	Fiyat (USD)
5509	Krom	20W	G4	1/100	<b>2.80</b>
5510	Mat Krom	20W	G4	1/100	<b>2.80</b>

VT9252 Pluton Spot



	Renk	Güç	Duy Tipi	Koli	Fiyat (USD)
5511	Krom	20W	G4	1/100	<b>2.50</b>
5512	Mat Krom	20W	G4	1/100	<b>2.50</b>

VT9260 Sıvaüstü



	Renk	Güç	Duy Tipi	Koli	Fiyat (USD)
5513	Krom	20W	G4	1/100	<b>4.60</b>
5514	Mat Krom	20W	G4	1/100	<b>4.60</b>

\*Balast ve Ampul Hariçtir





## VT9270 Pluton Spot



	Renk	Güç	Duy Tipi	Koli	Fiyat (USD)
5601	Krom	20W	G4	1/100	<b>3.95</b>
5602	Mat Krom	20W	G4	1/100	<b>3.95</b>

## Pluton Saç Kasa



	Kod	Renk	Duy Tipi	Koli	Fiyat (USD)
5603	<b>VDL11601-5310</b>	Beyaz	GU5.3	1/200	<b>1.23</b>
5604	<b>VDL11601-5382</b>	Krom	GU5.3	1/200	<b>1.35</b>
5605	<b>VDL11601-5383</b>	M. Krom	GU5.3	1/200	<b>1.35</b>

## DORA-1D Armatür



5606



Kod	<b>VDL18911-0132</b>
Güç	50W
Duy Tipi	AR111
Kutu/Koli	1/18
Fiyat (USD)	<b>12.60</b>

## DORA-2D Armatür



5607



Kod	<b>VDL18911-0232</b>
Güç	2x50W
Duy Tipi	AR111
Kutu/Koli	1/9
Fiyat (USD)	<b>20.10</b>

## DORA-3D Armatür



5608



Kod	<b>VDL18911-0332</b>
Güç	3x50W
Duy Tipi	AR111
Kutu/Koli	1/6
Fiyat (USD)	<b>26.10</b>

## Tetra-S LED'li Kare Downlight Armatür

100x0.1W  
LED

	Kod	Renk	Koli	Fiyat (USD)
5609	<b>VSI10101-0112</b>	Sıcak Beyaz	1/20	<b>60.00</b>
5610	<b>VSI10101-0116</b>	Soguk Beyaz	1/20	<b>60.00</b>

## Tetra-O LED'li Yuvarlak Downlight Armatür

97x0.1W  
LED

	Kod	Renk	Koli	Fiyat (USD)
5611	<b>VSI10101-0812</b>	Sıcak Beyaz	1/60	<b>60.00</b>
5612	<b>VSI10101-0816</b>	Soguk Beyaz	1/60	<b>60.00</b>

## Downlight Armatürler



## VT663E

İç Mekan Downlight

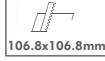

5701

Renk	Gri
Güç	2x20W
Duy Tipi	E27
Kutu/Koli	1/10
Fiyat (USD)	<b>33.00</b>

## VT664

İç Mekan Downlight



5702

Renk	Beyaz
Güç	2x18W
Duy Tipi	PLC
Kutu/Koli	1/10
Fiyat (USD)	<b>35.50</b>

## VT665

Kros Reflektörlü İç Mekan Downlight



5703

Renk	Beyaz
Güç	2x18W
Duy Tipi	PLC
Kutu/Koli	1/10
Fiyat (USD)	<b>35.50</b>

## VT659



5704

Renk	Beyaz
Güç	2x26W
Duy Tipi	PLC
Kutu/Koli	1/12
Fiyat (USD)	<b>20.90</b>

## VT659E



5705

Renk	Beyaz
Güç	2x40W
Duy Tipi	E27
Kutu/Koli	1/12
Fiyat (USD)	<b>20.90</b>

## VT660E



5706

Renk	Krom
Güç	2x40W
Duy Tipi	E27
Kutu/Koli	1/12
Fiyat (USD)	<b>24.30</b>

## VT661E



5707

Renk	Mat Krom
Güç	2x40W
Duy Tipi	E27
Kutu/Koli	1/12
Fiyat (USD)	<b>24.30</b>

## Atom-7S - LED'liSpot Ankastr



23V DC



	Kod	Renk	Güç	Koli	Fiyat (USD)
5708	VPI10301-0812	Sıcak Beyaz	0.5W	1/100	<b>6.30</b>
5709	VPI10301-0816	Soğuk Beyaz	0.5W	1/100	<b>6.30</b>
5710	VPI10301-0870	Mavi	0.5W	1/100	<b>6.30</b>

## LED Driver



5711

Kod	<b>VBL40113-0030</b>
Güç	5W
Ç. gerilimi	23V DC
Kutu/Koli	1/40
Fiyat (USD)	<b>13.00</b>

Atom-P - 350mA



	Kod	Renk	Güç	Ç. Gerilimi	Koli	Fiyat (USD)
5801	VPI10301-0112	Sıcak Beyaz	1W	3.5V DC	1/40	14.50
5802	VPI10301-0116	Soğuk Beyaz	1W	3.5V DC	1/40	14.50

Atom-P1 - 350mA



	Kod	Renk	Güç	Ç. Gerilimi	Koli	Fiyat (USD)
5803	VPI10301-1512	Sıcak Beyaz	1W	3.5V DC	1/40	12.20
5804	VPI10301-1516	Soğuk Beyaz	1W	3.5V DC	1/40	12.20

Alfa-P



	Kod	Renk	Güç	Ç. Gerilimi	Koli	Fiyat (USD)
5805	VPI10501-0112	Sıcak Beyaz	1W	220-240V	1/40	21.60
5806	VPI10501-0116	Soğuk Beyaz	1W	220-240V	1/40	21.60

Alfa-3P



	Kod	Renk	Güç	Ç. Gerilimi	Koli	Fiyat (USD)
5807	VPI10503-0112	Sıcak Beyaz	3x1W	220-240V	1/20	55.60
5808	VPI10503-0116	Soğuk Beyaz	3x1W	220-240V	1/20	55.60

Beta-3P



	Kod	Renk	Güç	Ç. Gerilimi	Koli	Fiyat (USD)
5809	VPI10703-0112	Sıcak Beyaz	3x1W	220-240V	1/20	44.70
5810	VPI10703-0116	Soğuk Beyaz	3x1W	220-240V	1/20	44.70

Beta-4P



	Kod	Renk	Güç	Ç. Gerilimi	Koli	Fiyat (USD)
5811	VPI10704-0112	Sıcak Beyaz	4x1W	220-240V	1/20	54.50
5812	VPI10704-0116	Soğuk Beyaz	4x1W	220-240V	1/20	54.50

## Power LED' li Downlight

## Beta-6P

Kod	Renk	Güç	Ç. Gerilimi	Koli	Fiyat (USD)
5901 <b>VPI10706-0112</b>	Sıcak Beyaz	6x1W	220-240V	1/20	<b>72.00</b>
5902 <b>VPI10706-0116</b>	Soğuk Beyaz	6x1W	220-240V	1/20	<b>72.00</b>



## Gama-1P

Kod	Renk	Güç	Ç. Gerilimi	Koli	Fiyat (USD)
5903 <b>VPI10901-0112</b>	Sıcak Beyaz	1W	220-240V	1/20	<b>36.00</b>
5904 <b>VPI10901-0116</b>	Soğuk Beyaz	1W	220-240V	1/20	<b>36.00</b>



## Gama-3P

Kod	Renk	Güç	Ç. Gerilimi	Koli	Fiyat (USD)
5905 <b>VPI10301-0112</b>	Sıcak Beyaz	1x3W	220-240V	1/20	<b>41.00</b>
5906 <b>VPI10301-0116</b>	Soğuk Beyaz	1x3W	220-240V	1/20	<b>41.00</b>



## Liza

Kod	Renk	Güç	Ç. Gerilimi	Koli	Fiyat (USD)
5907 <b>VPI11103-0150</b>	Sıcak Beyaz	1W	220-240V	1/20	<b>35.50</b>
5908 <b>VPI11103-0170</b>	Soğuk Beyaz	1W	220-240V	1/20	<b>37.00</b>



## Sigma-5P/10P/20P

Kod	Renk	Güç	Ç. Gerilimi	Koli	Fiyat (USD)
5909 <b>VPI12005-0112</b>	Sıcak Beyaz	1x5W	220-240V	1/20	<b>67.00</b>
5910 <b>VPI12005-0116</b>	Soğuk Beyaz	1x5W	220-240V	1/20	<b>67.00</b>
5911 <b>VPI12010-0112</b>	Sıcak Beyaz	1x10W	220-240V	1/16	<b>110.00</b>
5912 <b>VPI12010-0116</b>	Soğuk Beyaz	1x10W	220-240V	1/16	<b>110.00</b>
5913 <b>VPI12020-0112</b>	Sıcak Beyaz	1x20W	220-240V	1/8	<b>190.00</b>
5914 <b>VPI12020-0116</b>	Soğuk Beyaz	1x20W	220-240V	1/8	<b>190.00</b>





Downlight Armatürler

Vector-2V-3V-4V-5V Açık Dikey Downlightlar

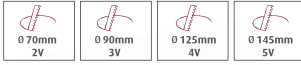

	Kod	Renk	Güç	Duy Tipi	Koli	Fiyat (USD)
6001	VDL10127-0283	2''Nikel	40W	E27	1/60	<b>2.80</b>
6002	VDL10127-0210	2''Beyaz	40W	E27	1/60	<b>2.40</b>
6003	VDL10127-2510	2.5''Nikel	40W	E27	1/60	<b>2.50</b>
6004	VDL10127-2583	2.5''Beyaz	40W	E27	1/60	<b>2.90</b>
6005	VDL10127-0383	3''Nikel	40W	E27	1/60	<b>3.80</b>
6006	VDL10127-0310	3''Beyaz	40W	E27	1/60	<b>3.20</b>
6007	VDL10127-0483	4''Nikel	40W	E27	1/50	<b>5.20</b>
6008	VDL10127-0410	4''Beyaz	40W	E27	1/50	<b>4.40</b>
6009	VDL10127-0583	5''Nikel	40W	E27	1/24	<b>6.30</b>
6010	VDL10127-0510	5''Beyaz	40W	E27	1/24	<b>5.50</b>

Vector-3GV-4GV-5GV Kapak Camlı Dikey Downlightlar



	Kod	Renk	Güç	Duy Tipi	Koli	Fiyat (USD)
6011	VDL10327-0383	3''Nikel	40W	E27	1/60	<b>6.90</b>
6012	VDL10327-0310	3''Beyaz	40W	E27	1/60	<b>6.30</b>
6013	VDL10327-0483	4''Nikel	40W	E27	1/24	<b>8.20</b>
6014	VDL10327-0410	4''Beyaz	40W	E27	1/24	<b>7.10</b>
6015	VDL10327-0583	5''Nikel	40W	E27	1/24	<b>9.50</b>
6016	VDL10327-0510	5''Beyaz	40W	E27	1/24	<b>9.30</b>

Vector-6H-8H Açık Yatay Downlightlar

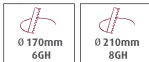

	Kod	Renk	Güç	Duy Tipi	Koli	Fiyat (USD)
6017	VDL10227-0683	6''Nikel	2xE27	E27	1/16	<b>9.20</b>
6018	VDL10227-0610	6''Beyaz	2xE27	E27	1/16	<b>8.20</b>
6019	VDL10224-0683	6''Nikel	2x18W	G24	1/16	<b>9.50</b>
6020	VDL10224-0610	6''Beyaz	2x18W	G24	1/16	<b>8.40</b>
6021	VDL10227-0883	8''Nikel	2xE27	E27	1/12	<b>12.90</b>
6022	VDL10227-0810	8''Beyaz	2xE27	E27	1/12	<b>11.90</b>
6023	VDL10224-0883	8''Nikel	2x26W	G24	1/12	<b>13.40</b>
6024	VDL10224-0810	8''Beyaz	2x26W	G24	1/12	<b>12.30</b>

Vector-6RGH-8RGH İçten Camlı Yatay Downlightlar

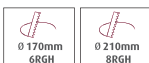

	Kod	Renk	Güç	Duy Tipi	Koli	Fiyat (USD)
6025	VDL10524-0683	6''Nikel	2x18W	G24	1/16	<b>12.20</b>
6026	VDL10524-0610	6''Beyaz	2x18W	G24	1/16	<b>10.90</b>
6027	VDL10524-0883	8''Nikel	2x36W	G24	1/12	<b>17.00</b>
6028	VDL10524-0810	8''Beyaz	2x36W	G24	1/12	<b>15.00</b>

\*Balast ve Ampul Hariçtir

## Downlight Armatürler

## Vega-6GH-8GH Kapak Camlı Yatay Downlightlar

	Kod	Renk	Güç	Duy Tipi	Koli	Fiyat (USD)
6101	VDL10427-0683	6''Nikel	2xE27	E27	1/16	12.30
6102	VDL10427-0610	6''Beyaz	2xE27	E27	1/16	10.70
6103	VDL10424-0683	6''Nikel	2x18W	G24	1/16	12.30
6104	VDL10424-0610	6''Beyaz	2x18W	G24	1/16	11.10
6105	VDL10427-0883	8''Nikel	2xE27	E27	1/12	17.20
6106	VDL10427-0810	8''Beyaz	2xE27	E27	1/12	16.50
6107	VDL10424-0883	8''Nikel	2x26W	G24	1/12	17.70
6108	VDL10424-0810	8''Beyaz	2x26W	G24	1/12	17.60



Nikel



## Turbo-8H

Yatay Downlight



6109



Kod	VDL10624-0810
Renk	Beyaz
Güç	2x26W
Duy Tipi	G24
Kutu/Koli	1/24
Fiyat (USD)	19.50

## Cross-8H

Yatay Downlight



6110



Kod	VDL10724-0810
Renk	Beyaz
Güç	2x26W
Duy Tipi	G24
Kutu/Koli	1/12
Fiyat (USD)	19.50

## Flora-8V

Sıva Üstü Dikey Downlight



Kod	6111	VDL16027-0810
	6112	VDL16027-0832
Renk	Beyaz/Gri	
Güç	40W	
Duy Tipi	E27	
Kutu/Koli	1/12	
Fiyat (USD)	21.50	

## Troy-O

Sıva Altı Salyangoz Metal Armatür



Kod	6113	VDL18512-0810
	6114	VDL18512-0832
Renk	Beyaz/Gri	
Güç	70W-150W	
Duy Tipi	G12	
Kutu/Koli	1/12	
Fiyat (USD)	38.50	

## Troy-S

Sıva Altı Kare Metal Armatür



Kod	6115	VDL18578-0810
	6116	VDL18578-0832
Renk	Beyaz/Gri	
Güç	70W	
Duy Tipi	R7s	
Kutu/Koli	1/16	
Fiyat (USD)	16.50	

## Sıva Altı Metal Armatür



Kod	6117	VT683
	6118	VT684
Renk	Beyaz / Krom	
Güç	150W	
Duy Tipi	R7s	
Kutu/Koli	1/12	
Fiyat (USD)	20.50 / 23.50	

VT2001



	Kod	Güç	Duy Tipi	Koli	Fiyat (USD)
6201	VT2001	6W	T5	1/30	<b>8.30</b>
6202	VT2001	8W	T5	1/30	<b>8.50</b>
6203	VT2001	13W	T5	1/30	<b>10.50</b>
6204	VT2001	21W	T5	1/30	<b>15.00</b>
6205	VT2001	28W	T5	1/30	<b>18.50</b>

VT2002



	Kod	Güç	Duy Tipi	Koli	Fiyat (USD)
6206	VT2002	8W	T4	1/30	<b>5.40</b>
6207	VT2002	12W	T4	1/30	<b>5.60</b>
6208	VT2002	16W	T4	1/30	<b>6.00</b>
6209	VT2002	20W	T4	1/30	<b>6.50</b>
6210	VT2002	22W	T4	1/30	<b>7.20</b>
6211	VT2002	26W	T4	1/30	<b>8.10</b>

VT2003



	Kod	Güç	Duy Tipi	Koli	Fiyat (USD)
6212	VT2003	8W	T5	1/30	<b>11.20</b>
6213	VT2003	13W	T5	1/30	<b>14.80</b>

VT2004A



	Kod	Güç	Duy Tipi	Koli	Fiyat (USD)
6214	VT2004A	8W	T4	1/30	<b>8.70</b>
6215	VT2004A	12W	T4	1/30	<b>9.60</b>
6216	VT2004A	16W	T4	1/30	<b>10.80</b>
6217	VT2004A	20W	T4	1/30	<b>12.00</b>

VT2004B



	Kod	Güç	Duy Tipi	Koli	Fiyat (USD)
6218	VT2004B	8W	T4	1/30	<b>9.10</b>
6219	VT2004B	12W	T4	1/30	<b>10.00</b>
6220	VT2004B	16W	T4	1/30	<b>11.50</b>
6221	VT2004B	20W	T4	1/30	<b>12.90</b>

VT3011



	Kod	Güç	Duy Tipi	Koli	Fiyat (USD)
6222	VT3011	10W	T8	1/10	<b>10.00</b>
6223	VT3011	15W	T8	1/10	<b>10.70</b>
6224	VT3011	18W	T8	1/10	<b>12.30</b>
6225	VT3011	30W	T8	1/10	<b>16.20</b>
6226	VT3011	36W	T8	1/10	<b>18.70</b>

## VT3005



	Kod	Güç	Duy Tipi	Koli	Fiyat (USD)
6301	VT3005	1x18W	T8	1/50	<b>5.00</b>
6302	VT3005	2x18W	T8	1/30	<b>9.20</b>
6303	VT3005	1x36W	T8	1/50	<b>6.30</b>
6304	VT3005	2x36W	T8	1/30	<b>11.40</b>

## VT3006



	Kod	Güç	Duy Tipi	Koli	Fiyat (USD)
6305	VT3006	18W	T8	1/50	<b>4.50</b>
6306	VT3006	36W	T8	1/50	<b>5.80</b>

## VT2024



	Kod	Güç	Duy Tipi	Koli	Fiyat (USD)
6307	VT2024	13W	T5	1/20	<b>20.10</b>
6308	VT2024	21W	T5	1/20	<b>26.90</b>

## VT3016



	Kod	Güç	Duy Tipi	Koli	Fiyat (USD)
6309	VT3016	18W	T8	1/30	<b>9.90</b>
6310	VT3016	36W	T8	1/30	<b>14.30</b>

## VT3020



	Kod	Güç	Duy Tipi	Koli	Fiyat (USD)
6311	VT3020	10W	T8	1/12	<b>18.70</b>
6312	VT3020	15W	T8	1/12	<b>20.10</b>
6313	VT3020	18W	T8	1/12	<b>23.20</b>
6314	VT3020	30W	T8	1/12	<b>25.80</b>
6315	VT3020	36W	T8	1/12	<b>32.50</b>





Mutfak, Banyo ve Dolap Bant Armatürleri - Elektronik Balastlı

**VT3021**



6401

Kod	VT3021
Güç	11W
Duy Tipi	PL
Kutu/Koli	1/12
Fiyat (USD)	<b>17.60</b>

**VT3150**



6402

Kod	VT3150
Güç	13W
Duy Tipi	T5
Kutu/Koli	1/12
Fiyat (USD)	<b>13.90</b>

**VT3160**



6403

Kod	VT3160
Güç	13W
Duy Tipi	T5
Kutu/Koli	1/16
Fiyat (USD)	<b>22.20</b>

**LEON**



	Kod	Güç	Duy Tipi	Koli	Fiyat (USD)
6414	VWL10801-1180	1x18W	T8	1/20	<b>14.40</b>
6415	VWL10801-1360	1x36W	T8	1/12	<b>21.90</b>
6416	VWL10801-2180	2x18W	T8	1/12	<b>22.10</b>
6417	VWL10801-2360	2x36W	T8	1/12	<b>33.50</b>

**VT3191**



	Kod	Güç	Duy Tipi	Koli	Fiyat (USD)
6408	VT3191	8W	T5	1/12	<b>36.50</b>
6409	VT3191	13W	T5	1/12	<b>43.00</b>

**LINE**



	Kod	Renk	Güç	Duy Tipi	Koli	Fiyat (USD)
6410	VWL10804-2180	Beyaz	2x18W	T8	1/6	<b>23.50</b>
6411	VWL10804-2181	Gümüs	2x18W	T8	1/6	<b>25.30</b>
6412	VWL10804-2360	Beyaz	2x36W	T8	1/6	<b>32.00</b>
6413	VWL10804-2361	Gümüs	2x36W	T8	1/6	<b>35.50</b>

**VT3100**



	Kod	Güç	Duy Tipi	Koli	Fiyat (USD)
6404	VT3100	8W	T5	1/12	<b>14.90</b>
6405	VT3100	13W	T5	1/12	<b>20.50</b>
6406	VT3100	21W	T5	1/12	<b>27.20</b>
6407	VT3100	28W	T5	1/12	<b>34.30</b>

## Bant Armatürler

## Sac Bant Armatür



Kod	Güç	Duy Tipi	Koli	Fiyat (USD)
6501 VT3120	1x18W	T8	1/10	9.00
6502 VT3140	1x36W	T8	1/10	10.30

## Sac Bant Armatür



Kod	Güç	Duy Tipi	Koli	Fiyat (USD)
6503 VT3220	2x18W	T8	1/10	10.90
6504 VT3240	2x36W	T8	1/10	15.80

## Sac Bant Armatür - Slim



Kod	Güç	Duy Tipi	Koli	Fiyat (USD)
6505 VWL10820-1180	1x18W	T8	1/10	7.55
6506 VWL10820-1360	1x36W	T8	1/10	8.35

## Sac Bant Armatür - Slim



Kod	Güç	Duy Tipi	Koli	Fiyat (USD)
6507 VWL10820-2180	2x18W	T8	1/10	9.45
6508 VWL10820-2360	2x36W	T8	1/10	13.25

## Sac Bant Armatür -Elektronik Balastlı



Kod	Güç	Duy Tipi	Koli	Fiyat (USD)
6509 VWL10821-1180	1x18W	T8	1/10	8.40
6510 VWL10821-1360	1x36W	T8	1/10	9.15

## Sac Bant Armatür - Elektronik Balastlı



Kod	Güç	Duy Tipi	Koli	Fiyat (USD)
6511 VWL10821-2180	2x18W	T8	1/10	11.00
6512 VWL10821-2360	2x36W	T8	1/10	16.00

## Linea-S - Etanj Armatür



Kod	Güç	Duy Tipi	Koli	Fiyat (USD)
6513 VWP10801-1180	1x18W	T8	1/10	16.00
6514 VWP10801-1360	1x36W	T8	1/8	21.50

## Linea-S - Etanj Armatür



Kod	Güç	Duy Tipi	Koli	Fiyat (USD)
6515 VWP10801-2180	2x18W	T8	1/6	18.90
6516 VWP10801-2360	2x36W	T8	1/6	29.80

## Etanj Armatür

VT7009



6517

Güç	1x9W
Duy Tipi	PL
Kutu/Koli	1/12
Fiyat (USD)	16.40



Nemli Yer Armatürleri

Nemli Yer Arm. <



6601

Kod	VT300
Renk	Beyaz
Güç	60W
Duy Tipi	E27
Kutu/Koli	1/18
Fiyat (USD)	<b>5.90</b>

Nemli Yer Arm. <



6602

Kod	VT301
Renk	Beyaz
Güç	60W
Duy Tipi	E27
Kutu/Koli	1/18
Fiyat (USD)	<b>6.30</b>

Nemli Yer Arm. <



6603

Kod	VT302
Renk	Siyah
Güç	60W
Duy Tipi	E27
Kutu/Koli	1/18
Fiyat (USD)	<b>5.90</b>

Nemli Yer Arm. <



6604

Kod	VT303
Renk	Siyah
Güç	60W
Duy Tipi	E27
Kutu/Koli	1/18
Fiyat (USD)	<b>6.30</b>

Nemli Yer Arm. <



6605

Kod	VT301C
Renk	Beyaz
Güç	60W
Duy Tipi	E27
Kutu/Koli	1/20
Fiyat (USD)	<b>9.50</b>

Nemli Yer Arm. <



6606

Kod	VT303C
Renk	Siyah
Güç	60W
Duy Tipi	E27
Kutu/Koli	1/20
Fiyat (USD)	<b>9.50</b>

Nemli Yer Arm. <



6607

Kod	VT301A
Renk	Beyaz
Güç	60W
Duy Tipi	E27
Kutu/Koli	1/20
Fiyat (USD)	<b>9.50</b>

Nemli Yer Arm. <



6608

Kod	VT303A
Renk	Siyah
Güç	60W
Duy Tipi	E27
Kutu/Koli	1/20
Fiyat (USD)	<b>9.50</b>

Nemli Yer Arm. <



6609

Kod	VT304
Renk	Beyaz
Güç	60W
Duy Tipi	E27
Kutu/Koli	1/24
Fiyat (USD)	<b>6.60</b>

Nemli Yer Arm. <



6610

Kod	VT305
Renk	Siyah
Güç	60W
Duy Tipi	E27
Kutu/Koli	1/24
Fiyat (USD)	<b>6.60</b>

Nemli Yer Arm. <



6611

Kod	VT310
Renk	Beyaz
Güç	60W
Duy Tipi	E27
Kutu/Koli	1/18
Fiyat (USD)	<b>6.50</b>

Nemli Yer Arm. <



6612

Kod	VT312
Renk	Siyah
Güç	60W
Duy Tipi	E27
Kutu/Koli	1/18
Fiyat (USD)	<b>6.50</b>

## Nemli Yer Armatürleri

## Nemli Yer Arm. &lt;



6701

Kod	VT311
Renk	Beyaz
Güç	60W
Duy Tipi	E27
Kutu/Koli	1/18
Fiyat (USD)	<b>6.60</b>

## Nemli Yer Arm. &lt;



6702

Kod	VT313
Renk	Siyah
Güç	60W
Duy Tipi	E27
Kutu/Koli	1/18
Fiyat (USD)	<b>6.60</b>

## Nemli Yer Arm. &lt;



6703

Kod	VT340
Renk	Beyaz
Güç	60W
Duy Tipi	E27
Kutu/Koli	1/18
Fiyat (USD)	<b>16.40</b>

## Nemli Yer Arm. &lt;



6704

Kod	VT341
Renk	Siyah
Güç	60W
Duy Tipi	E27
Kutu/Koli	1/12
Fiyat (USD)	<b>16.40</b>

## Nemli Yer Arm. &lt;



6705

Kod	VT342
Renk	Beyaz
Güç	60W
Duy Tipi	E27
Kutu/Koli	1/12
Fiyat (USD)	<b>16.40</b>

## Nemli Yer Arm. &lt;



6706

Kod	VT343
Renk	Siyah
Güç	60W
Duy Tipi	E27
Kutu/Koli	1/18
Fiyat (USD)	<b>16.40</b>

## Nemli Yer Arm. &lt;



6707

Kod	VT344
Renk	Beyaz
Güç	60W
Duy Tipi	E27
Kutu/Koli	1/12
Fiyat (USD)	<b>16.40</b>

## Nemli Yer Arm. &lt;



6708

Kod	VT345
Renk	Siyah
Güç	60W
Duy Tipi	E27
Kutu/Koli	1/12
Fiyat (USD)	<b>16.40</b>

## Nemli Yer Arm. &lt;



6709

Kod	VT356
Renk	Beyaz
Güç	40W
Duy Tipi	E27
Kutu/Koli	1/24
Fiyat (USD)	<b>10.80</b>

## Nemli Yer Arm. &lt;



6710

Kod	VT357
Renk	Siyah
Güç	40W
Duy Tipi	E27
Kutu/Koli	1/24
Fiyat (USD)	<b>10.80</b>



VT438L Kapaklı

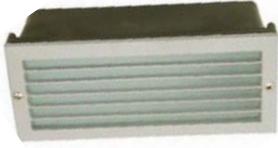

6801

Kod	VT438L
Renk	Gri
Güç	60W
Duy Tipi	E27
Kutu/Koli	1/18
Fiyat (USD)	<b>9.70</b>

VT438M Kapaklı



6802

Kod	VT438M
Renk	Gri
Güç	40W
Duy Tipi	E27
Kutu/Koli	1/24
Fiyat (USD)	<b>7.90</b>

VT438S



6803

Kod	VT438S
Renk	Gri
Güç	25W
Duy Tipi	E14
Kutu/Koli	1/40
Fiyat (USD)	<b>6.50</b>

VT439A Kapaklı



6804

Kod	VT439A
Renk	Sıcak Beyaz
Güç	18x0.12W
Duy Tipi	LED
Kutu/Koli	1/24
Fiyat (USD)	<b>20.10</b>

VT439A

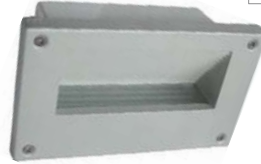

IP44

6805

Kod	VT439A
Renk	Gri
Güç	40W
Duy Tipi	G6.35
Kutu/Koli	1/24
Fiyat (USD)	<b>8.80</b>

VT439B Kapaklı



IP44

6806

Kod	VT439B
Renk	Sıcak Beyaz
Güç	12x0.12W
Duy Tipi	LED
Kutu/Koli	1/24
Fiyat (USD)	<b>16.70</b>

VT439B



6807

Kod	VT439B
Renk	Gri
Güç	40W
Duy Tipi	G6.35
Kutu/Koli	1/24
Fiyat (USD)	<b>8.80</b>

**Nemli Yer Armatürleri**



**Landa-O**



IP65

	Kod	Renk	Güç	Koli	Fiyat (USD)
6901	<b>VBH10101-0170</b>	Mavi	14x0.1W	1/40	<b>29.00</b>
6902	<b>VBH10101-0116</b>	Soguk Beyaz	14x0.1W	1/40	<b>29.00</b>
6903	<b>VBH10101-0112</b>	Sıcak Beyaz	14x0.1W	1/40	<b>29.00</b>

**Landa-S**



IP65

	Kod	Renk	Güç	Koli	Fiyat (USD)
6904	<b>VBH10102-0170</b>	Mavi	14x0.1W	1/40	<b>29.00</b>
6905	<b>VBH10102-0116</b>	Soguk Beyaz	14x0.1W	1/40	<b>29.00</b>
6906	<b>VBH10102-0112</b>	Sıcak Beyaz	14x0.1W	1/40	<b>29.00</b>

**Landa-S1**



IP65

	Kod	Renk	Güç	Koli	Fiyat (USD)
6907	<b>VBH10103-0170</b>	Mavi	18x0.1W	1/30	<b>34.00</b>
6908	<b>VBH10103-0116</b>	Soguk Beyaz	18x0.1W	1/30	<b>34.00</b>
6909	<b>VBH10103-0112</b>	Sıcak Beyaz	18x0.1W	1/30	<b>34.00</b>

**Landa-S2**



IP65

	Kod	Renk	Güç	Koli	Fiyat (USD)
6910	<b>VBH10104-0170</b>	Mavi	18x0.1W	1/20	<b>36.50</b>
6911	<b>VBH10104-0116</b>	Soguk Beyaz	18x0.1W	1/20	<b>36.50</b>
6912	<b>VBH10104-0112</b>	Sıcak Beyaz	18x0.1W	1/20	<b>36.50</b>

**Landa-R**



IP54

	Kod	Renk	Güç	Koli	Fiyat (USD)
6913	<b>VBH10201-0170</b>	Mavi	12x0.1W	1/40	<b>23.50</b>
6914	<b>VBH10201-0116</b>	Soguk Beyaz	12x0.1W	1/40	<b>23.50</b>
6915	<b>VBH10201-0112</b>	Sıcak Beyaz	12x0.1W	1/40	<b>23.50</b>

**Maldiv-R**



IP68

	Kod	Renk	Güç	Koli	Fiyat (USD)
6916	<b>VGL10101-0170</b>	Mavi	18x0.1W	1/50	<b>31.00</b>
6917	<b>VGL10101-0116</b>	Soguk Beyaz	18x0.1W	1/50	<b>31.00</b>
6918	<b>VGL10101-0112</b>	Sıcak Beyaz	18x0.1W	1/50	<b>31.00</b>

**Maldiv-R1**



12V  
IP68

	Kod	Renk	Güç	Koli	Fiyat (USD)
6919	<b>VGL10102-0170</b>	Mavi	39x0.1W	1/40	<b>39.00</b>
6920	<b>VGL10102-0116</b>	Soguk Beyaz	39x0.1W	1/40	<b>39.00</b>
6921	<b>VGL10102-0112</b>	Sıcak Beyaz	39x0.1W	1/40	<b>39.00</b>



## Ledus-5S

Kod	Renk	Güç	Koli	Fiyat (USD)
7001 <b>VGL10145-0170</b>	Mavi	5x0.1W	1/50	<b>25.70</b>
7002 <b>VGL10145-0116</b>	Soguk Beyaz	5x0.1W	1/50	<b>25.70</b>
7003 <b>VGL10145-0112</b>	Sıcak Beyaz	5x0.1W	1/50	<b>25.70</b>

IP65



## Doris-9P

Kod	Renk	Güç	Koli	Fiyat (USD)
7004 <b>VGL10201-0370</b>	Mavi	3x1W	1/20	<b>89.00</b>
7005 <b>VGL10201-0316</b>	Soguk Beyaz	3x1W	1/20	<b>89.00</b>
7006 <b>VGL10201-0312</b>	Sıcak Beyaz	3x1W	1/20	<b>89.00</b>

IP67



12V

## Doris-11P

Kod	Renk	Güç	Koli	Fiyat (USD)
7007 <b>VGL10202-0370</b>	Mavi	3x1W	1/20	<b>135.00</b>
7008 <b>VGL10202-0316</b>	Soguk Beyaz	3x1W	1/20	<b>135.00</b>
7009 <b>VGL10202-0312</b>	Sıcak Beyaz	3x1W	1/20	<b>135.00</b>

IP67



220-240V

## VT434



IP65

7010

Renk	Beyaz
Güç	28x0.12W
Kutu/Koli	1/6
Fiyat (USD)	<b>64.00</b>

## VT535



IP67

7011

Renk	Mavi
Güç	12x0.1W
Kutu/Koli	1/32
Fiyat (USD)	<b>37.00</b>

## VT535



IP67

7012

Renk	2700K
Güç	12x0.1W
Kutu/Koli	1/32
Fiyat (USD)	<b>37.00</b>

## VT536



IP67

7013

Renk	2700K
Güç	12x0.1W
Kutu/Koli	1/32
Fiyat (USD)	<b>39.00</b>

## VT536



IP67

7014

Renk	Mavi
Güç	12x0.1W
Kutu/Koli	1/32
Fiyat (USD)	<b>39.00</b>

## VT538



IP67

Balast, Atesleyici, Ampul Haric

7015

Güç	50W
Duy Tipi	GU10
Kutu/Koli	1/24
Fiyat (USD)	<b>35.00</b>

## VT539



IP67

Ampul Haric

7016

Güç	100W
Duy Tipi	E27
Kutu/Koli	1/12
Fiyat (USD)	<b>89.00</b>

## VT540



IP67

Balast, Atesleyici, Ampul Haric

7017

Güç	150W
Duy Tipi	G12
Kutu/Koli	1/4
Fiyat (USD)	<b>170.00</b>

Bahçe Armatür Serileri



HAVANA-D

VGL12001-0154

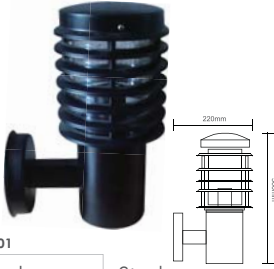

7101

Renk	Siyah
Güç	60W
Duy Tipi	E27
Kutu/Koli	1/6
Fiyat (USD)	<b>44.50</b>

HAVANA-30

VGL12001-0304

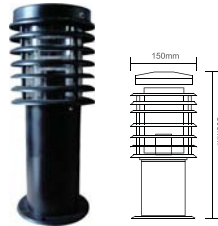

7102

Renk	Siyah
Güç	60W
Duy Tipi	E27
Kutu/Koli	1/6
Fiyat (USD)	<b>44.50</b>

HAVANA-50

VGL12001-0504

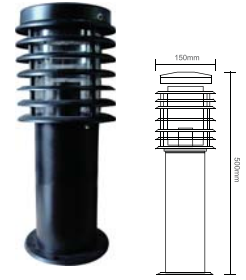

7103

Renk	Siyah
Güç	60W
Duy Tipi	E27
Kutu/Koli	1/4
Fiyat (USD)	<b>50.00</b>

VIANA-D

VGL12002-0154



7104

Renk	INOX
Güç	60W
Duy Tipi	E27
Kutu/Koli	1/12
Fiyat (USD)	<b>46.00</b>

VIANA-45

VGL12002-0454

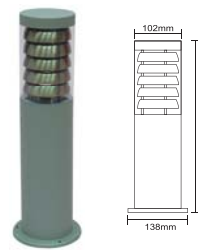

7105

Renk	INOX
Güç	60W
Duy Tipi	E27
Kutu/Koli	1/6
Fiyat (USD)	<b>52.00</b>

VIANA-80

VGL12002-0804



7106

Renk	INOX
Güç	60W
Duy Tipi	E27
Kutu/Koli	1/4
Fiyat (USD)	<b>62.00</b>

VT700

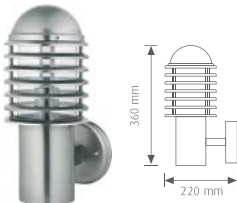

7107

Renk	Mat Krom
Güç	60W
Duy Tipi	E27
Kutu/Koli	1/6
Fiyat (USD)	<b>60.50</b>

VT701

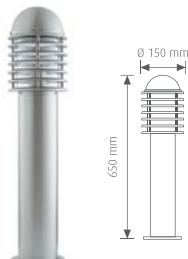

7108

Renk	Mat Krom
Güç	60W
Duy Tipi	E27
Kutu/Koli	1/6
Fiyat (USD)	<b>54.00</b>

VT701S

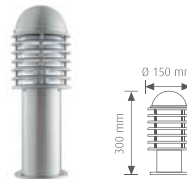

7109

Renk	Mat Krom
Güç	60W
Duy Tipi	E27
Kutu/Koli	1/4
Fiyat (USD)	<b>70.00</b>

VT702

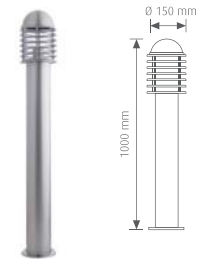

7110

Renk	Mat Krom
Güç	60W
Duy Tipi	E27
Kutu/Koli	1/4
Fiyat (USD)	<b>82.50</b>





## SPIDER-1D

VGL14001-0183



7201

Renk	Nikel
Güç	50W
Duy Tipi	MR16
Kutu/Koli	1/24
Fiyat (USD)	<b>18.00</b>

## SPIDER-2D

VGL14001-1683

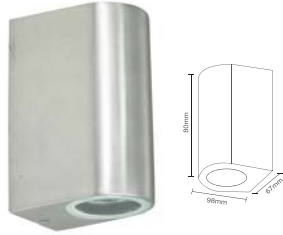

7202

Renk	Nikel
Güç	2x50W
Duy Tipi	MR16
Kutu/Koli	1/16
Fiyat (USD)	<b>24.00</b>

## VT726



7203

Renk	Siyah
Güç	2x50W
Duy Tipi	GU10
Kutu/Koli	1/9
Fiyat (USD)	<b>26.80</b>

## VT727



7204

Renk	Siyah
Güç	2x60W
Duy Tipi	GU10
Kutu/Koli	1/6
Fiyat (USD)	<b>36.00</b>

## VT720 - LED



7205

Renk	Mat Krom
Güç	16x0.1W
Kutu/Koli	1/16
Fiyat (USD)	<b>43.00</b>

## VT721 - LED



7206

Renk	Mat Krom
Güç	6x0.1W
Kutu/Koli	1/12
Fiyat (USD)	<b>32.00</b>

## VT722 - LED



7207

Renk	Mat Krom
Güç	6x0.1W
Kutu/Koli	1/8
Fiyat (USD)	<b>36.00</b>

## VT724



7208

Renk	Gri
Güç	40W
Duy Tipi	G9
Kutu/Koli	1/16
Fiyat (USD)	<b>16.90</b>

## VT710

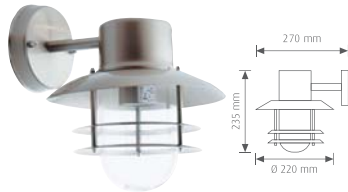

7209

Renk	Mat Krom
Güç	60W
Duy Tipi	E27
Kutu/Koli	1/4
Fiyat (USD)	<b>38.50</b>

## VT711

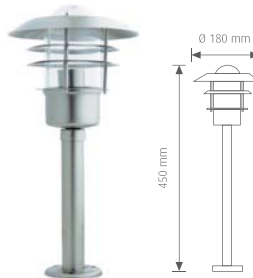

7210

Renk	Mat Krom
Güç	60W
Duy Tipi	E27
Kutu/Koli	1/4
Fiyat (USD)	<b>39.70</b>

## VT712

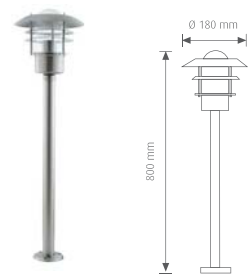

7211

Renk	Mat Krom
Güç	60W
Duy Tipi	E27
Kutu/Koli	1/4
Fiyat (USD)	<b>45.60</b>

Bahçe Armatür Serileri



**GARDENIA-D** <<  
VGL13201-2000



7301

Renk	Seffaf
Güç	40W
Duy Tipi	E27
Kutu/Koli	1/12
Fiyat (USD)	<b>11.50</b>

**GARDENIA-35** <<  
VGL13202-2000



7302

Renk	Seffaf
Güç	40W
Duy Tipi	E27
Kutu/Koli	1/16
Fiyat (USD)	<b>11.50</b>

**GARDENIA-G** <<  
VGL13204-2000  
Şeffaf Küre



7303

Renk	Seffaf
Güç	40W
Duy Tipi	E27
Kutu/Koli	1/18
Fiyat (USD)	<b>8.80</b>

**VGL13203-0110** <<  
Direk



7304

Renk	Siyah
Kutu/Koli	1/18
Fiyat (USD)	<b>17.50</b>

**VT733** <<



7305

Renk	Mat Krom
Güç	11W
Duy Tipi	E27
Kutu/Koli	1/8
Fiyat (USD)	<b>19.80</b>

**VT734** <<



7306

Renk	Mat Krom
Güç	11W
Duy Tipi	E27
Kutu/Koli	1/8
Fiyat (USD)	<b>16.30</b>

**VT735** <<



7307

Renk	Mat Krom
Güç	11W
Duy Tipi	E27
Kutu/Koli	1/6
Fiyat (USD)	<b>24.80</b>

**VT736** <<



7308

Renk	Mat Krom
Güç	11W
Duy Tipi	E27
Kutu/Koli	1/6
Fiyat (USD)	<b>30.90</b>

**VT748A** <<

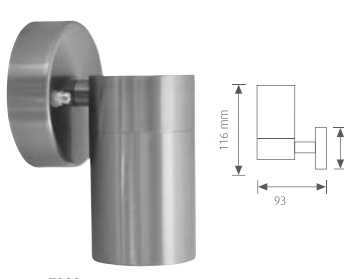

7309

Renk	Mat Krom
Güç	50W
Duy Tipi	GU10
Kutu/Koli	1/24
Fiyat (USD)	<b>17.00</b>

**VT748B** <<

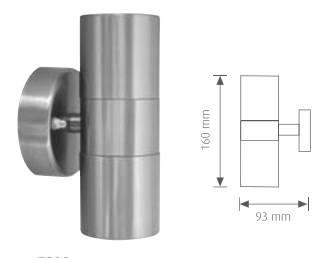

7310

Renk	Mat Krom
Güç	2x50W
Duy Tipi	GU10
Kutu/Koli	1/12
Fiyat (USD)	<b>23.00</b>

**VT748C** <<



7311

Renk	Mat Krom
Güç	2x50W
Duy Tipi	GU10
Kutu/Koli	1/6
Fiyat (USD)	<b>45.50</b>



## VT750

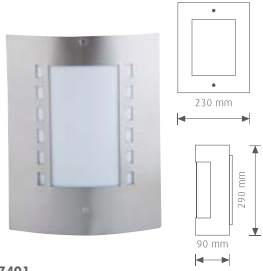

7401

Renk	Mat Krom
Güç	60W
Duy Tipi	E27
Kutu/Koli	1/8
Fiyat (USD)	<b>20.20</b>

## VT750 - Sensörlü

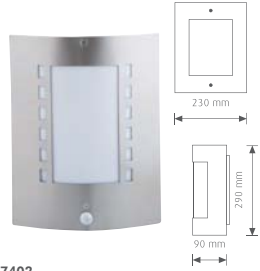

7402

Renk	Mat Krom
Güç	60W
Duy Tipi	E27
Kutu/Koli	1/8
Fiyat (USD)	<b>37.60</b>

## VT751

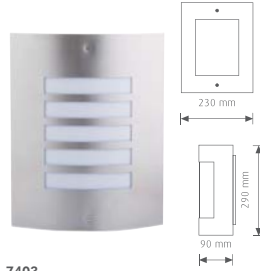

7403

Renk	Mat Krom
Güç	60W
Duy Tipi	E27
Kutu/Koli	1/8
Fiyat (USD)	<b>21.90</b>

## VT751 - Sensörlü



7404

Renk	Mat Krom
Güç	60W
Duy Tipi	E27
Kutu/Koli	1/8
Fiyat (USD)	<b>37.60</b>

## VT745A



7405

Renk	Siyah
Güç	35W
Duy Tipi	GU10
Kutu/Koli	1/40
Fiyat (USD)	<b>10.90</b>

## VT745B



7406

Renk	Siyah
Güç	35W
Duy Tipi	GU10
Kutu/Koli	1/40
Fiyat (USD)	<b>10.90</b>

## VT745C



7407

Renk	Siyah
Güç	35W
Duy Tipi	GU10
Kutu/Koli	1/40
Fiyat (USD)	<b>10.90</b>

## VT728 - Sensörlü

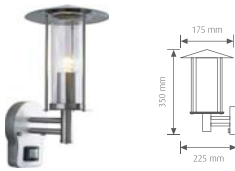

7408

Renk	Mat Krom
Güç	60W
Duy Tipi	E27
Kutu/Koli	1/6
Fiyat (USD)	<b>47.00</b>

## VT729



7409

Renk	Mat Krom
Güç	60W
Duy Tipi	E27
Kutu/Koli	1/6
Fiyat (USD)	<b>23.60</b>

## VT757

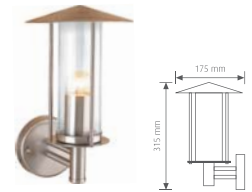

7410

Renk	Mat Krom
Güç	60W
Duy Tipi	E27
Kutu/Koli	1/6
Fiyat (USD)	<b>32.00</b>

VT760



7501

Renk	Mat Krom
Güç	60W
Duy Tipi	E27
Kutu/Koli	1/4
Fiyat (USD)	<b>28.70</b>

VT760 - Sensörlü



7502

Renk	Mat Krom
Güç	60W
Duy Tipi	E27
Kutu/Koli	1/4
Fiyat (USD)	<b>43.00</b>

VT761



7503

Renk	Mat Krom
Güç	60W
Duy Tipi	E27
Kutu/Koli	1/4
Fiyat (USD)	<b>30.70</b>

VT762

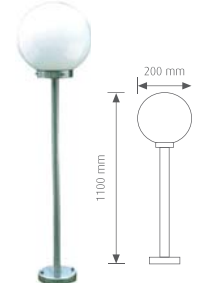

7504

Renk	Mat Krom
Güç	60W
Duy Tipi	E27
Kutu/Koli	1/4
Fiyat (USD)	<b>37.50</b>

VT764



7505

Renk	Mat Krom
Güç	60W
Duy Tipi	E27
Kutu/Koli	1/8
Fiyat (USD)	<b>14.80</b>

VT764 - Sensörlü



7506

Renk	Mat Krom
Güç	60W
Duy Tipi	E27
Kutu/Koli	1/8
Fiyat (USD)	<b>27.40</b>

VT765

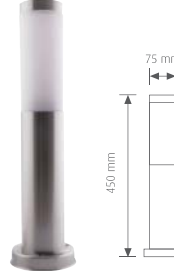

7507

Renk	Mat Krom
Güç	60W
Duy Tipi	E27
Kutu/Koli	1/6
Fiyat (USD)	<b>20.50</b>

VT766

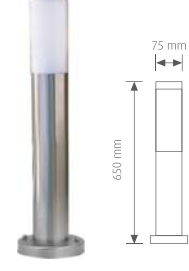

7508

Renk	Mat Krom
Güç	60W
Duy Tipi	E27
Kutu/Koli	1/4
Fiyat (USD)	<b>26.50</b>

VT767

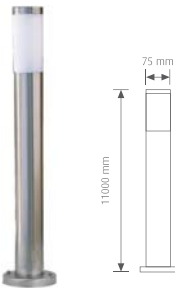

7509

Renk	Mat Krom
Güç	60W
Duy Tipi	E27
Kutu/Koli	1/4
Fiyat (USD)	<b>35.50</b>

VT779

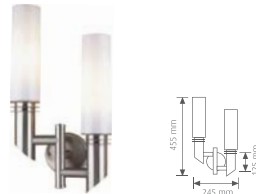

7510

Renk	Mat Krom
Güç	60W
Duy Tipi	E27
Kutu/Koli	1/6
Fiyat (USD)	<b>35.50</b>

VT780



7511

Renk	Mat Krom
Güç	60W
Duy Tipi	E27
Kutu/Koli	1/6
Fiyat (USD)	<b>29.00</b>

**MADRID-D**

VGL13001-0154



7601

Renk	Siyah
Güç	60W
Duy Tipi	E27
Kutu/Koli	1/10
Fiyat (USD)	<b>14.70</b>

**MADRID-H**

VGL13001-0174



7602

Renk	Siyah
Güç	60W
Duy Tipi	E27
Kutu/Koli	1/10
Fiyat (USD)	<b>14.70</b>

**MADRID-40**

VGL13001-0404



7603

Renk	Siyah
Güç	60W
Duy Tipi	E27
Kutu/Koli	1/10
Fiyat (USD)	<b>14.70</b>

**MADRID-120**

VGL13001-1204

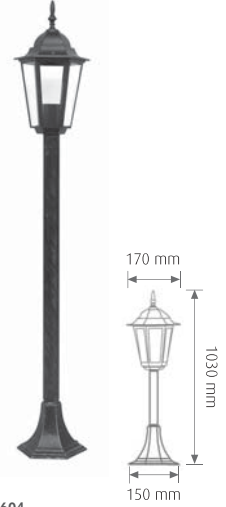

7604

Renk	Siyah
Güç	60W
Duy Tipi	E27
Kutu/Koli	1/10
Fiyat (USD)	<b>27.50</b>

**PRAG-D**

VGL13002-0154



7605

Renk	Siyah
Güç	60W
Duy Tipi	E27
Kutu/Koli	1/10
Fiyat (USD)	<b>17.80</b>

**PRAG-H**

VGL13002-0174



7606

Renk	Siyah
Güç	60W
Duy Tipi	E27
Kutu/Koli	1/10
Fiyat (USD)	<b>17.80</b>

**PRAG-50**

VGL13002-0504



7607

Renk	Siyah
Güç	60W
Duy Tipi	E27
Kutu/Koli	1/10
Fiyat (USD)	<b>17.80</b>

**PRAG-120**

VGL13002-1204



7608

Renk	Siyah
Güç	60W
Duy Tipi	E27
Kutu/Koli	1/10
Fiyat (USD)	<b>29.10</b>

## Bahçe Armatür Serileri



## Milano-D

VGL12003-0153

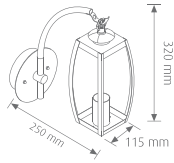

7701

Renk	Nikel
Güç	60W
Duy Tipi	E27
Kutu/Koli	1/6
Fiyat (USD)	<b>50.00</b>

## Milano-H

VGL12003-0173

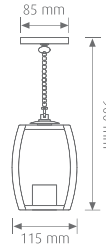

7702

Renk	Nikel
Güç	60W
Duy Tipi	E27
Kutu/Koli	1/6
Fiyat (USD)	<b>50.00</b>

## Milano-80

VGL12003-0803

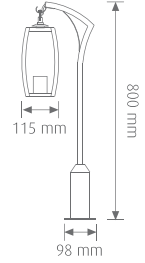

7703

Renk	Nikel
Güç	60W
Duy Tipi	E27
Kutu/Koli	1/4
Fiyat (USD)	<b>62.00</b>

## Milano-D

VGL12004-0154

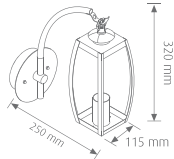

7704

Renk	Siyah
Güç	60W
Duy Tipi	E27
Kutu/Koli	1/6
Fiyat (USD)	<b>50.00</b>

## Milano-H

VGL12004-0174

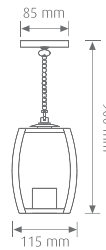

7705

Renk	Siyah
Güç	60W
Duy Tipi	E27
Kutu/Koli	1/6
Fiyat (USD)	<b>50.00</b>

## Milano-80

VGL12004-0804

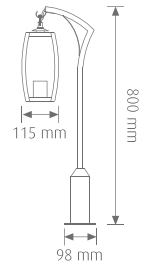

7706

Renk	Siyah
Güç	60W
Duy Tipi	E27
Kutu/Koli	1/4
Fiyat (USD)	<b>62.00</b>

VT781



7901

Renk	Mat Krom
Güç	60W
Duy Tipi	E27
Kutu/Koli	1/6
Fiyat (USD)	<b>33.70</b>

VT782



7902

Renk	Mat Krom
Güç	60W
Duy Tipi	E27
Kutu/Koli	1/6
Fiyat (USD)	<b>33.70</b>

VT782S

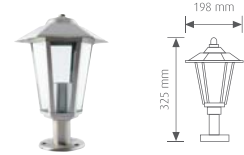

7903

Renk	Mat Krom
Güç	60W
Duy Tipi	E27
Kutu/Koli	1/6
Fiyat (USD)	<b>34.70</b>

VT783



7904

Renk	Mat Krom
Güç	60W
Duy Tipi	E27
Kutu/Koli	1/4
Fiyat (USD)	<b>41.20</b>

VT784

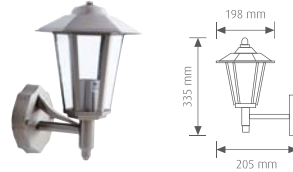

7905

Renk	Mat Krom
Güç	60W
Duy Tipi	E27
Kutu/Koli	1/6
Fiyat (USD)	<b>33.70</b>

VT785



7906

Renk	Mat Krom
Güç	60W
Duy Tipi	E27
Kutu/Koli	1/6
Fiyat (USD)	<b>31.80</b>

VT785S



7907

Renk	Mat Krom
Güç	60W
Duy Tipi	E27
Kutu/Koli	1/6
Fiyat (USD)	<b>27.80</b>

VT786

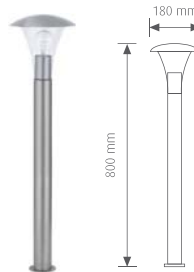

7908

Renk	Mat Krom
Güç	60W
Duy Tipi	E27
Kutu/Koli	1/4
Fiyat (USD)	<b>36.10</b>

VT787



7909

Renk	Mat Krom
Güç	60W
Duy Tipi	E27
Kutu/Koli	1/6
Fiyat (USD)	<b>30.80</b>

## Bahçe Armatür Serileri



## VT791 - Solar / LED'li

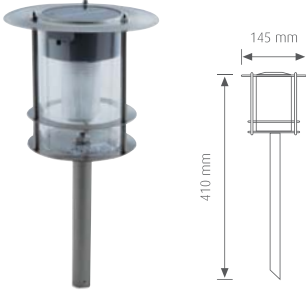

7901

Renk	Mat Krom
Güç	2x0.2W
Kutu/Koli	1/6
Fiyat (USD)	<b>32.80</b>

## VT706 - Solar / LED'li



Renk	7902 Mavi
	7903 Kırmızı
Güç	2x0.06W
Kutu/Koli	1/36
Fiyat (USD)	<b>13.80</b>

## VT715 - Sualtı

Ampulsüz

12V



7904

Güç	50W
Duy Tipi	GU5.3
Kutu/Koli	1/8
Fiyat (USD)	<b>86.00</b>

## VT716 - Sualtı

Ampulsüz

12V



7905

Güç	50W
Duy Tipi	GU5.3
Kutu/Koli	1/16
Fiyat (USD)	<b>28.50</b>

## LOTUS - Sualtı

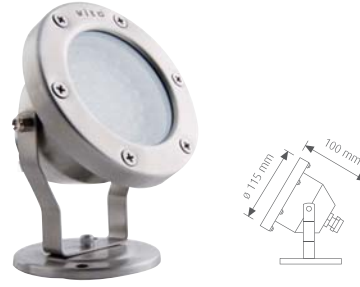
LED' li, Trafo Hariç  
12V

Kod	Renk	Güç	Koli	Fiyat (USD)	
7906	VGL10310-0112	Sıcak Beyaz	48x0.1W	1/8	<b>86.00</b>
7907	VGL10310-0160	Mavi	48x0.1W	1/8	<b>86.00</b>
7908	VGL10310-0170	Yesil	48x0.1W	1/8	<b>86.00</b>
7909	VGL10310-0172	RGB	48x0.1W	1/8	<b>102.00</b>

## VT718 - Sualtı

Power LED' li, Trafo Hariç

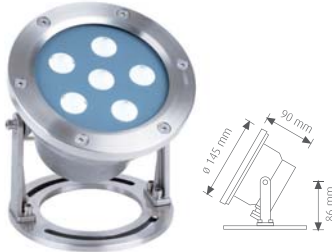

7910

Güç	6x1W
Ç. Gerilimi	12V
Kutu/Koli	1/4
Fiyat (USD)	<b>245.00</b>

## JUNCTION BOX - S Tipi

VGL19901-0183

Kablo Çapı:  
5.5mm x 7.5mm

7911

Kutu/Koli	1/60
Fiyat (USD)	<b>25.00</b>

## JUNCTION BOX - A Tipi

VGL19901-0283

Kablo Çapı:  
7.5mm x 10mm

7912

Kutu/Koli	1/45
Fiyat (USD)	<b>36.00</b>





Masa Lambaları - Ampulsüz

VT021



Renk	8001	Mavi
	8002	Yeşil
	8003	Turuncu
	8004	Gümüş
Güç		40W
Duy Tipi		E14
Kutu/Koli		1/8
Fiyat (USD)		<b>20.50</b>

VT022



Renk	8005	Mavi
	8006	Yeşil
	8007	Beyaz
	8008	Gümüş
Güç		20W
Duy Tipi		E27
Kutu/Koli		1/6
Fiyat (USD)		<b>27.00</b>

VT023



Renk	8009	Mavi
	8010	Yeşil
	8011	Beyaz
	8012	Gümüş
	8013	Sarı
	8014	Siyah
Güç		20W
Duy Tipi		E27
Kutu/Koli		1/12
Fiyat (USD)		<b>17.50</b>

VT036



Renk	8015	Siyah
	8016	Beyaz
Güç		40W
Duy Tipi		E27
Kutu/Koli		1/24
Fiyat (USD)		<b>13.50</b>

VT037



Renk	8017	Mavi
	8018	Siyah
	8019	Yeşil
	8020	Kırmızı
	8021	Gümüş
Güç		40W
Duy Tipi		E14
Kutu/Koli		1/8
Fiyat (USD)		<b>18.50</b>

VT038



Renk	8022	Mavi
	8023	Yeşil
	8024	Sarı
Güç		40W
Duy Tipi		E14
Kutu/Koli		1/8
Fiyat (USD)		<b>15.00</b>

VT039



Renk	8025	Siyah
	8026	Beyaz
	8027	Kırmızı-Siyah
Güç		40W
Duy Tipi		E14
Kutu/Koli		1/12
Fiyat (USD)		<b>10.50</b>

VT050



Renk	8028	Siyah
	8029	Mavi
	8030	Kırmızı
	8031	Beyaz
Güç		60W
Duy Tipi		E27
Kutu/Koli		1/20
Fiyat (USD)		<b>9.90</b>

VT067



Renk	8032	Siyah
	8033	Mavi
	8034	Kırmızı
	8035	Beyaz
Güç		60W
Duy Tipi		E27
Kutu/Koli		1/30
Fiyat (USD)		<b>9.40</b>

VT106



Renk	8036	Siyah
	8037	Kırmızı
	8038	Beyaz
Güç		60W
Duy Tipi		E27
Kutu/Koli		1/30
Fiyat (USD)		<b>9.00</b>

VT090



Renk	8039	Mavi
	8040	Yeşil
Güç		60W
Duy Tipi		E27
Kutu/Koli		1/6
Fiyat (USD)		<b>47.00</b>

## VT033



Renk	8101	Siyah
Güç		50W
Duy Tipi		GU10
Kutu/Koli		1/12
Fiyat (USD)		<b>21.50</b>

## VT035



Renk	8102	Sarı-Yesil,
	8103	Pembe-Mavi
Güç		9W
Duy Tipi		PL
Kutu/Koli		1/12
Fiyat (USD)		<b>16.00</b>

## VT069



Renk	8104	Siyah
	8105	Kırmızı
	8106	Beyaz
Güç		11W
Duy Tipi		PL
Kutu/Koli		1/6
Fiyat (USD)		<b>21.00</b>

## VT069B



Renk	8107	Siyah
	8108	Kırmızı
	8109	Beyaz
Güç		11W
Duy Tipi		PL
Kutu/Koli		1/6
Fiyat (USD)		<b>19.00</b>

## VT070



Renk	8110	Siyah
	8111	Gri
	8112	Beyaz
Güç		11W
Duy Tipi		PL
Kutu/Koli		1/12
Fiyat (USD)		<b>19.50</b>

## VT073



Renk	8113	Siyah
	8114	Kırmızı
	8115	Beyaz
Güç		40W
Duy Tipi		E27
Kutu/Koli		1/12
Fiyat (USD)		<b>17.80</b>

## VT095



Renk	8116	Mavi
	8117	Yeşil
	8118	Pembe
Güç		11W
Duy Tipi		PL
Kutu/Koli		1/10
Fiyat (USD)		<b>22.50</b>

## VT096



Renk	8119	Mavi
	8120	Yeşil
	8121	Pembe
Güç		11W
Duy Tipi		PL
Kutu/Koli		1/6
Fiyat (USD)		<b>17.00</b>

## VT097



Renk	8122	Mavi
	8123	Yeşil
	8124	Pembe
Güç		11W
Duy Tipi		PL
Kutu/Koli		1/16
Fiyat (USD)		<b>16.00</b>



**TORCH-1**

VRE10101-0163



8201

Renk	Gri
Güç	9x0.1W
Kutu/Koli	1/16
Fiyat (USD)	<b>11.70</b>

**TORCH-8**

VRE10103-0163



8202

Renk	Gri
Güç	0.1x19W
Kutu/Koli	1/12
Fiyat (USD)	<b>29.50</b>

**TORCH-35**

VRE10102-0140



8203

Renk	Sarı-Siyah
Güç	35x0.1W
Kutu/Koli	1/16
Fiyat (USD)	<b>29.00</b>

**VT294A**



8204

Renk	Siyah-Gri
Güç	18x0.1W
Kutu/Koli	1/30
Fiyat (USD)	<b>17.70</b>

**VT297L**



Renk	8205 Mavi
	8206 Kırmızı
Güç	19x0.1W
Kutu/Koli	1/10
Fiyat (USD)	<b>29.00</b>

**VT294S**

Güneş Enerjili - LED' li



8207

Renk	Transparan
Güç	12x0.1W
Kutu/Koli	1/30
Fiyat (USD)	<b>23.70</b>

**VT294H**



8208

Renk	Siyah-Gri
Güç	7x0.1W
Kutu/Koli	1/48
Fiyat (USD)	<b>18.80</b>

**VT396L**



8209

Renk	Siyah
Güç	9x0.1W
Kutu/Koli	1/12
Fiyat (USD)	<b>32.00</b>

**VT290L**



8210

Renk	Mavi
Güç	20x0.1W
Kutu/Koli	1/6
Fiyat (USD)	<b>26.50</b>

**VT292**



8211

Renk	Yeşil
Güç	24x0.1W
Kutu/Koli	1/6
Fiyat (USD)	<b>41.00</b>

## Işıldaklar



## VRE 018L

VRE10401-6210



8301

Renk	Beyaz
Güç	120x0.1W
Kutu/Koli	1/24
Fiyat (USD)	<b>47.00</b>

## VRE 018L

VRE10401-3210



8302

Renk	Beyaz
Güç	90x0.1W
Kutu/Koli	1/12
Fiyat (USD)	<b>38.50</b>

## RINA

VRE10201-0110



8303

Renk	Beyaz
Güç	36x0.1W
Kutu/Koli	1/8
Fiyat (USD)	<b>28.70</b>

## TINA

VRE10202-0110



8304

Renk	Beyaz
Güç	27x0.1W
Kutu/Koli	1/8
Fiyat (USD)	<b>26.50</b>

## VT281



8305

Renk	Beyaz
Güç	20W
Duy Tipi	T8
Kutu/Koli	1/8
Fiyat (USD)	<b>36.00</b>

## VT283



8306

Renk	Beyaz-Gri
Güç	2x8W
Duy Tipi	T5
Kutu/Koli	1/10
Fiyat (USD)	<b>22.20</b>

## VT284



8207

Renk	Beyaz-Gri
Güç	2x6W
Duy Tipi	T5
Kutu/Koli	1/10
Fiyat (USD)	<b>25.80</b>

## VT387L



8308

Renk	Gri-Beyaz
Güç	44x0.1W
Kutu/Koli	1/10
Fiyat (USD)	<b>32.00</b>

## VT2007L



8309

Renk	Trans.Siyah
Güç	35x0.1W
Kutu/Koli	1/12
Fiyat (USD)	<b>35.80</b>

## VT2008L



8310

Renk	Siyah
Güç	30x0.1W
Kutu/Koli	1/24
Fiyat (USD)	<b>33.20</b>



Acil Çıkış Lambaları

VT299



8401

Renk	Gri-Yeşil
Güç	6x0.1W
Kutu/Koli	1/20
Fiyat (USD)	18.50

VT399



8402

Renk	Gri
Güç	10x0.06W
Kutu/Koli	1/100
Fiyat (USD)	15.50

VT399 - Acil Çıkış Camı

Aşağı Opsiyonu



8403

Renk	Yeşil
Kutu/Koli	1/25
Fiyat (USD)	5.80

VT399 - Acil Çıkış Camı

Yukarı Opsiyonu



8404

Renk	Yeşil
Kutu/Koli	1/25
Fiyat (USD)	5.80

VT399 - Acil Çıkış Camı

Sağ Çıkış Opsiyonu



8405

Renk	Yeşil
Kutu/Koli	1/25
Fiyat (USD)	5.80

VT399 - Acil Çıkış Camı

Sol Çıkış Opsiyonu



8406

Renk	Yeşil
Kutu/Koli	1/25
Fiyat (USD)	5.80

VRE02L

VRE10702-2410



8407

Renk	Beyaz
Güç	24x0.1W
Kutu/Koli	1/10
Fiyat (USD)	16.70

VRE01L

VRE-10701-1810



8408

Renk	Beyaz
Güç	18x0.1W
Kutu/Koli	1/20
Fiyat (USD)	14.80

## Dekoratif Mumlar &amp; Işıdaklar



## VT860 - Dekoratif Mum



8501

Renk	Beyaz
Güç	2.25W
Set/Adet	6
Kutu/Koli	1/16
Fiyat (USD)	<b>41.00</b>

## VT861 - Dekoratif Mum



	Renk	Güç	Set / Adet	Kutu/Koli	Fiyat (USD)
8502	Mavi	2.25W	6	1/16	<b>41.00</b>
8503	Yeşil	2.25W	6	1/16	<b>41.00</b>
8504	Kırmızı	2.25W	6	1/16	<b>41.00</b>
8505	Beyaz	2.25W	6	1/16	<b>41.00</b>

## VT862 - Dekoratif Mum



8506

Renk	Sarı
Güç	12x0.05W
Set	12
Kutu/Koli	1/24
Fiyat (USD)	<b>7.70</b>

## VT822



8507

Renk	Gri
Güç	8x0.1W
Kutu/Koli	1/36
Fiyat (USD)	<b>6.40</b>

## VT823



8508

Renk	Mavi
Güç	1x0.06W
Kutu/Koli	1/36
Fiyat (USD)	<b>3.50</b>

## VT851



8509

Renk	Beyaz
Güç	10x0.1W
Kutu/Koli	1/24
Fiyat (USD)	<b>13.60</b>

## VT850



8510

Renk	Beyaz
Güç	10x0.1W
Kutu/Koli	1/24
Fiyat (USD)	<b>14.00</b>

**VNL10101-0110 - LADYBIRD** - Uğur Böceği Tipi LED'li Gece Lambası



8601

Kod	VNL10101-0110
Renk	Turuncu-Beyaz
Güç	4x0.1W
Kutu/Koli	50/200
Fiyat (USD)	<b>2.00</b>

**VT803L** - Kedi Tipi LED'li Gece Lambası



	Renk	Güç	Koli	Fiyat (USD)
8602	Mavi	4x0.1W	50/200	<b>1.72</b>
8603	Yeşil	4x0.1W	50/200	<b>1.72</b>
8604	Pembe	4x0.1W	50/200	<b>1.72</b>
8605	Beyaz	4x0.1W	50/200	<b>1.72</b>
8606	Sarı	4x0.1W	50/200	<b>1.72</b>

**VT804L** - Penguen Tipi LED'li Gece Lambası



	Renk	Güç	Koli	Fiyat (USD)
8607	Mavi	4x0.1W	50/200	<b>1.78</b>
8608	Yeşil	4x0.1W	50/200	<b>1.78</b>
8609	Pembe	4x0.1W	50/200	<b>1.78</b>
8610	Siyah	4x0.1W	50/200	<b>1.78</b>
8611	Sarı	4x0.1W	50/200	<b>1.78</b>

**VT805L** - Günes Tipi LED'li Gece Lambası



	Renk	Güç	Koli	Fiyat (USD)
8612	Mavi	4x0.1W	50/200	<b>1.70</b>
8613	Yeşil	4x0.1W	50/200	<b>1.70</b>
8614	Pembe	4x0.1W	50/200	<b>1.70</b>
8615	Beyaz	4x0.1W	50/200	<b>1.70</b>
8616	Sarı	4x0.1W	50/200	<b>1.70</b>

**VT806L** - LED'li Gece Lambası



	Renk	Güç	Koli	Fiyat (USD)
8617	Mavi	4x0.1W	50/200	<b>1.70</b>
8618	Yeşil	4x0.1W	50/200	<b>1.70</b>
8619	Pembe	4x0.1W	50/200	<b>1.70</b>
8620	Beyaz	4x0.1W	50/200	<b>1.70</b>

## Gece Lambaları

## VT807L- LED'li Manzaralı Gece Lambası



	Renk	Güç	Koli	Fiyat (USD)
8701	Beyaz	4x0.1W	50/200	<b>1.78</b>

## VT808 - Gül Tipi LED'li Gece Lambası



	Renk	Güç	Koli	Fiyat (USD)
8702	Mavi	4x0.1W	50/200	<b>1.55</b>
8703	Yesil	4x0.1W	50/200	<b>1.55</b>
8704	Pembe	4x0.1W	50/200	<b>1.55</b>
8705	Beyaz	4x0.1W	50/200	<b>1.55</b>

## VT809 - Kelebek Tipi LED'li Gece Lambası



	Renk	Güç	Koli	Fiyat (USD)
8706	Mavi	4x0.1W	50/200	<b>1.50</b>
8707	Yesil	4x0.1W	50/200	<b>1.50</b>
8708	Pembe	4x0.1W	50/200	<b>1.50</b>
8709	Beyaz	4x0.1W	50/200	<b>1.50</b>

## VT810 - Günes Tipi LED'li Gece Lambası



	Renk	Güç	Koli	Fiyat (USD)
8710	Mavi	4x0.1W	50/200	<b>1.55</b>
8711	Yesil	4x0.1W	50/200	<b>1.55</b>
8712	Pembe	4x0.1W	50/200	<b>1.55</b>
8713	Beyaz	4x0.1W	50/200	<b>1.55</b>

## VT811 - Kalp Tipi LED'li Gece Lambası



	Renk	Güç	Koli	Fiyat (USD)
8714	Mavi	4x0.1W	50/200	<b>1.50</b>
8715	Yesil	4x0.1W	50/200	<b>1.50</b>
8716	Pembe	4x0.1W	50/200	<b>1.50</b>
8717	Beyaz	4x0.1W	50/200	<b>1.50</b>





Balast ve Trafolar

T8 Elektronik Balast



	Kod	Güç	Koli	Fiyat (USD)
8801	<b>VT460</b>	1x10W	1/200	<b>4.00</b>
8802	<b>VT461</b>	1x15W	1/200	<b>4.00</b>
8803	<b>VT462</b>	1x18W	1/200	<b>4.00</b>
8804	<b>VT463</b>	1x30W	1/200	<b>4.05</b>
8805	<b>VT464</b>	1x36W	1/200	<b>4.90</b>

T8 Elektronik Balast



	Kod	Güç	Koli	Fiyat (USD)
8806	<b>VT465</b>	2x18W	1/200	<b>8.10</b>
8807	<b>VT466</b>	2x36W	1/200	<b>8.90</b>

T8 Elektronik Balast



	Kod	Güç	Koli	Fiyat (USD)
8808	<b>VT467</b>	4x18W	1/50	<b>16.70</b>
8809	<b>VT468</b>	4x36W	1/50	<b>20.40</b>

Elektronik Transformatör



	Kod	Güç	Koli	Fiyat (USD)
8810	<b>VT450</b>	60W/12V	10/200	<b>3.70</b>
8811	<b>VT451</b>	105W/12V	1/100	<b>6.50</b>
	<b>VT452</b>	150W/12V	1/100	<b>8.60</b>

Elektronik Trafo EMC'li

Dim Edilebilir



8812	Kod	<b>VO41060</b>
	Çıkış Gerilimi	60W
	Güç	12V/4.9A
	Kutu/Koli	1/100
	Fiyat (USD)	<b>10.20</b>

Elektronik Trafo EMC'li

Dim Edilebilir



8813	Kod	<b>VO410105</b>
	Çıkış Gerilimi	105W
	Güç	12V/8.8A
	Kutu/Koli	1/100
	Fiyat (USD)	<b>13.40</b>

Elektronik Trafo EMC'li

Dim Edilebilir



8814	Kod	<b>VO410150</b>
	Çıkış Gerilimi	150W
	Güç	12V/12.7A
	Kutu/Koli	1/50
	Fiyat (USD)	<b>22.40</b>

## Sensör, Starter ve Duylar

## Sensör-Tavan



8901

Kod	VT275
Renk	Beyaz
Görüş Açısı	360°
Kutu/Koli	1/60
Fiyat (USD)	<b>10.50</b>

## Sensör-Duvar



8902

Kod	VT276
Renk	Beyaz
Görüş Açısı	180°
Kutu/Koli	1/36
Fiyat (USD)	<b>9.80</b>

## Sensör-Duvar



8903

Kod	VT277
Renk	Beyaz
Görüş Açısı	145°
Kutu/Koli	1/50
Fiyat (USD)	<b>9.80</b>

## Fotosensör



8904

Kod	VT279B
Renk	Beyaz
Max. Yük.	AC-10A, 2000W
Kutu/Koli	1/100
Fiyat (USD)	<b>7.00</b>

## Fotosensör



8905

Kod	VT279C
Renk	Beyaz
Max. Yük.	AC-15A,1500W AC-25A,3000W
Kutu/Koli	1/100
Fiyat (USD)	<b>8.30</b>

## Starter - S10



8906

Kod	S10
Max. Yük.	4-65W
Kutu/Koli	25/1000
Fiyat (USD)	<b>0.21</b>

## Starter - S2



8907

Kod	S2
Max. Yük.	4-22W
Kutu/Koli	25/1000
Fiyat (USD)	<b>0.24</b>

## G9 Duy



8908

Kod	VT256
Kutu/Koli	1/400
Fiyat (USD)	<b>0.95</b>

## E14 Porselen Duy



8909

Kod	VT261
Kutu/Koli	1/400
Fiyat (USD)	<b>0.22</b>

## E27 Porselen Duy



8910

Kod	VT262
	13 02 62
Kutu/Koli	1/400
Fiyat (USD)	<b>0.23</b>

## E27 Porselen Duy

Sac Ayaklı



8911

Kod	VT262L
Kutu/Koli	1/400
Fiyat (USD)	<b>0.32</b>

**G6.35-20cm**

Seramik Duy



9001

Kod	VT264
Kutu/Koli	100/2000
Fiyat (USD)	<b>0.23</b>

**G6.35-10cm**

Seramik Duy



9002

Kod	VT264
Kutu/Koli	100/2000
Fiyat (USD)	<b>0.16</b>

**G6.35-15cm**

Seramik Duy



9003

Kod	VT264
Kutu/Koli	100/2000
Fiyat (USD)	<b>0.22</b>

**GU10-15cm**

Seramik Duy



9004

Kod	VT265
Kutu/Koli	100/2000
Fiyat (USD)	<b>0.45</b>

**E27**

Porselen Duy



9005

Kod	VT263
Kutu/Koli	1/360
Fiyat (USD)	<b>0.40</b>

**E40 Porselen Duy**

Sac Ayaklı



9006

Kod	VT266
Kutu/Koli	1/100
Fiyat (USD)	<b>1.75</b>

**E40 Porselen Duy**

9007

Kod	VT267
Kutu/Koli	1/100
Fiyat (USD)	<b>2.10</b>

**E14 Bakalit Duy**

Rondelalı-Siyah



9008

Kod	VT268
Kutu/Koli	1/500
Fiyat (USD)	<b>0.65</b>

**E27 Bakalit Duy**

Rondelalı-Siyah



9009

Kod	VT269
Kutu/Koli	1/400
Fiyat (USD)	<b>0.70</b>

## Duyar

## R7S Duy

Lineer Ampuller-78mm



9101

Kod	VT270A
Kutu/Koli	1/400
Fiyat (USD)	<b>0.70</b>

## R7S Duy

Lineer Ampuller-118mm



9102

Kod	VT270B
Kutu/Koli	1/400
Fiyat (USD)	<b>0.73</b>

## E27 Plastik Duy

Rondelalı Beyaz



9103

Kod	VT257
Kutu/Koli	1/300
Fiyat (USD)	<b>0.57</b>

## E27 Plastik Duy

Düz Beyaz



9104

Kod	VT258
Kutu/Koli	1/400
Fiyat (USD)	<b>0.46</b>

## E14 Plastik Duy

Rondelalı Beyaz



9105

Kod	VT259
Kutu/Koli	1/500
Fiyat (USD)	<b>0.45</b>

## E14 Plastik Duy

Düz Beyaz



9106

Kod	VT260
Kutu/Koli	1/600
Fiyat (USD)	<b>0.38</b>

## İpli Switch

Anahtar - Siyah



9107

Kod	RPS
Çal. Gerilimi	220V/240V
Kutu/Koli	250/2000
Fiyat (USD)	<b>0.60</b>

## Kapı Zili



Kod	9108	VDB40601-0110
	9109	VDB40602-0110
Kutu/Koli	48	
Fiyat (USD)	<b>13.20</b>	

## Bağlantı

Aksesuarları



9110

Kod	VT623K
Kutu/Koli	5000
Fiyat (USD)	<b>0.25</b>

## Bağlantı

Aksesuarları



9111

Kod	VTCAT5E
Kutu/Koli	1000
Fiyat (USD)	<b>1.45</b>

## Metal Bağlantı

Aksesuarları



9112

Kod	VTCAT6
Kutu/Koli	1000
Fiyat (USD)	<b>2.80</b>

## Plastik Bağlantı

Aksesuarları



9113

Kod	VTCAT6
Kutu/Koli	2000
Fiyat (USD)	<b>1.60</b>



## Kablo Bağları - Beyaz

	Model	Renk	Kutu/Koli	Fiyat (USD)
9201	<b>2.5x100mm</b> • Kablo Bağı	Beyaz	100/500	<b>0.70</b>
9202	<b>2.5x150mm</b> • Kablo Bağı	Beyaz	100/500	<b>1.17</b>
9203	<b>2.5x200mm</b> • Kablo Bağı	Beyaz	100/250	<b>1.75</b>
9204	<b>3.6x150mm</b> • Kablo Bağı	Beyaz	100/250	<b>1.87</b>
9205	<b>3.6x200mm</b> • Kablo Bağı	Beyaz	100/200	<b>2.25</b>
9206	<b>3.6x250mm</b> • Kablo Bağı	Beyaz	100/200	<b>3.30</b>
9207	<b>3.6x300mm</b> • Kablo Bağı	Beyaz	100/150	<b>3.95</b>
9208	<b>3.6x370mm</b> • Kablo Bağı	Beyaz	100/100	<b>5.29</b>
9209	<b>4.8x200mm</b> • Kablo Bağı	Beyaz	100/150	<b>3.35</b>
9210	<b>4.8x250mm</b> • Kablo Bağı	Beyaz	100/100	<b>4.40</b>
9211	<b>4.8x300mm</b> • Kablo Bağı	Beyaz	100/100	<b>5.20</b>
9212	<b>4.8x350mm</b> • Kablo Bağı	Beyaz	100/100	<b>6.15</b>
9213	<b>4.8x370mm</b> • Kablo Bağı	Beyaz	100/100	<b>6.65</b>
9214	<b>4.8x400mm</b> • Kablo Bağı	Beyaz	100/100	<b>8.10</b>
9215	<b>7.2x300mm</b> • Kablo Bağı	Beyaz	100/25	<b>9.10</b>
9216	<b>7.2x350mm</b> • Kablo Bağı	Beyaz	100/25	<b>12.90</b>
9217	<b>7.2x400mm</b> • Kablo Bağı	Beyaz	100/50	<b>15.90</b>
9218	<b>7.2x450mm</b> • Kablo Bağı	Beyaz	100/25	<b>16.30</b>
9219	<b>9x650mm</b> • Kablo Bağı	Beyaz	100/10	<b>24.20</b>
9220	<b>9x1020mm</b> • Kablo Bağı	Beyaz	100/10	<b>60.00</b>

## Yapışkan Kroşe

	Model	Renk	Kutu/Koli	Fiyat (USD)
9221	<b>20x20mm</b> • Yapışkan Kroşe	Beyaz	100/250	<b>3.50</b>
9222	<b>28x28mm</b> • Yapışkan Kroşe	Beyaz	100/80	<b>6.00</b>



## Otomatik Sigortalar

### 3kA Otomatik Sigortalar C Tipi - Monofaze



Model	Kutup Sayısı	Anma Akımı	Kesme Kapasitesi	Kutu/Koli	Fiyat (USD)
9301 <b>BG03 1P 2A</b>	1P	2A	3kA	12/240	<b>2.75</b>
9302 <b>BG03 1P 3A</b>	1P	3A	3kA	12/240	<b>2.75</b>
9303 <b>BG03 1P 4A</b>	1P	4A	3kA	12/240	<b>2.75</b>
9304 <b>BG03 1P 6A</b>	1P	6A	3kA	12/240	<b>2.20</b>
9305 <b>BG03 1P 10A</b>	1P	10A	3kA	12/240	<b>2.20</b>
9306 <b>BG03 1P 16A</b>	1P	16A	3kA	12/240	<b>2.20</b>
9307 <b>BG03 1P 20A</b>	1P	20A	3kA	12/240	<b>2.20</b>
9308 <b>BG03 1P 25A</b>	1P	25A	3kA	12/240	<b>2.20</b>
9309 <b>BG03 1P 32A</b>	1P	32A	3kA	12/240	<b>2.40</b>
9310 <b>BG03 1P 40A</b>	1P	40A	3kA	12/240	<b>2.55</b>
9311 <b>BG03 1P 50A</b>	1P	50A	3kA	12/240	<b>2.60</b>
9312 <b>BG03 1P 63A</b>	1P	63A	3kA	12/240	<b>2.60</b>
9313 <b>BG03 1P 80A</b>	1P	80A	3kA	12/72	<b>8.40</b>
9314 <b>BG03 1P 100A</b>	1P	100A	3kA	12/72	<b>8.40</b>

### 3kA Otomatik Sigortalar C Tipi - İki Kutuplu



Model	Kutup Sayısı	Anma Akımı	Kesme Kapasitesi	Kutu/Koli	Fiyat (USD)
9315 <b>BG03 2P 25A</b>	2P (1P+N)	25A	3kA	6/120	<b>4.50</b>
9316 <b>BG03 2P 32A</b>	2P (1P+N)	32A	3kA	6/120	<b>4.50</b>
9317 <b>BG03 2P 40A</b>	2P (1P+N)	40A	3kA	6/120	<b>5.15</b>
9318 <b>BG03 2P 63A</b>	2P (1P+N)	63A	3kA	6/120	<b>5.30</b>

### 3kA Otomatik Sigortalar C Tipi - Trifaze



Model	Kutup Sayısı	Anma Akımı	Kesme Kapasitesi	Kutu/Koli	Fiyat (USD)
9319 <b>BG03 3P 6A</b>	3P	6A	3kA	4/80	<b>6.70</b>
9320 <b>BG03 3P 10A</b>	3P	10A	3kA	4/80	<b>6.70</b>
9321 <b>BG03 3P 16A</b>	3P	16A	3kA	4/80	<b>6.70</b>
9322 <b>BG03 3P 20A</b>	3P	20A	3kA	4/80	<b>6.70</b>
9323 <b>BG03 3P 25A</b>	3P	25A	3kA	4/80	<b>6.70</b>
9324 <b>BG03 3P 32A</b>	3P	32A	3kA	4/80	<b>6.95</b>
9325 <b>BG03 3P 40A</b>	3P	40A	3kA	4/80	<b>7.65</b>
9326 <b>BG03 3P 50A</b>	3P	50A	3kA	4/80	<b>7.80</b>
9327 <b>BG03 3P 63A</b>	3P	63A	3kA	4/80	<b>7.80</b>
9328 <b>BG03 3P 80A</b>	3P	80A	3kA	4/24	<b>25.80</b>
9329 <b>BG03 3P 100A</b>	3P	100A	3kA	4/24	<b>25.80</b>

## 3kA Otomatik Sigortalar C Tipi - Dört Kutuplu

Model	Kutup Sayısı	Anma Akımı	Kesme Kapasitesi	Kutu/Koli	Fiyat (USD)
9401 <b>BG03 4P 25A</b>	4P (3P+N)	25A	3kA	3/60	<b>8.90</b>
9402 <b>BG03 4P 32A</b>	4P (3P+N)	32A	3kA	3/60	<b>8.90</b>
9403 <b>BG03 4P 40A</b>	4P (3P+N)	40A	3kA	3/60	<b>10.20</b>
9404 <b>BG03 4P 63A</b>	4P (3P+N)	63A	3kA	3/60	<b>10.50</b>



## 6kA Otomatik Sigortalar C Tipi - Monofaze



Model	Kutup Sayısı	Anma Akımı	Kesme Kapasitesi	Kutu/Koli	Fiyat (USD)
9405 <b>BG06 1P 6A 6kA</b>	1P	6A	6kA	12/240	<b>4.00</b>
9406 <b>BG06 1P 10A 6kA</b>	1P	10A	6kA	12/240	<b>4.00</b>
9407 <b>BG06 1P 16A 6kA</b>	1P	16A	6kA	12/240	<b>4.00</b>
9408 <b>BG06 1P 20A 6kA</b>	1P	20A	6kA	12/240	<b>4.00</b>
9409 <b>BG06 1P 25A 6kA</b>	1P	25A	6kA	12/240	<b>4.00</b>
9410 <b>BG06 1P 32A 6kA</b>	1P	32A	6kA	12/240	<b>4.20</b>
9411 <b>BG06 1P 40A 6kA</b>	1P	40A	6kA	12/240	<b>4.30</b>
9412 <b>BG06 1P 50A 4.5kA</b>	1P	50A	4.5kA	12/240	<b>4.40</b>
9413 <b>BG06 1P 63A 4.5kA</b>	1P	63A	4.5kA	12/240	<b>4.40</b>



## 6kA Otomatik Sigortalar C Tipi - Trifaze



Model	Kutup Sayısı	Anma Akımı	Kesme Kapasitesi	Kutu/Koli	Fiyat (USD)
9414 <b>BG06 3P 6A 6kA</b>	3P	6A	6kA	4/80	<b>12.00</b>
9415 <b>BG06 3P 10A 6kA</b>	3P	10A	6kA	4/80	<b>12.00</b>
9416 <b>BG06 3P 16A 6kA</b>	3P	16A	6kA	4/80	<b>12.00</b>
9417 <b>BG06 3P 20A 6kA</b>	3P	20A	6kA	4/80	<b>12.00</b>
9418 <b>BG06 3P 25A 6kA</b>	3P	25A	6kA	4/80	<b>12.00</b>
9419 <b>BG06 3P 32A 6kA</b>	3P	32A	6kA	4/80	<b>12.30</b>
9420 <b>BG06 3P 40A 6kA</b>	3P	40A	6kA	4/80	<b>12.90</b>
9421 <b>BG06 3P 50A 4.5kA</b>	3P	50A	4.5kA	4/80	<b>13.00</b>
9422 <b>BG06 3P 63A 4.5kA</b>	3P	63A	4.5kA	4/80	<b>13.00</b>



## 10kA Otomatik Sigortalar C Tipi - Monofaze



Model	Kutup Sayısı	Anma Akımı	Kesme Kapasitesi	Kutu/Koli	Fiyat (USD)
9423 <b>BG10 1P 6A 10kA</b>	1P	6A	10kA	12/240	<b>4.90</b>
9424 <b>BG10 1P 10A 10kA</b>	1P	10A	10kA	12/240	<b>4.90</b>
9425 <b>BG10 1P 16A 10kA</b>	1P	16A	10kA	12/240	<b>4.90</b>
9426 <b>BG10 1P 20A 10kA</b>	1P	20A	10kA	12/240	<b>4.90</b>
9427 <b>BG10 1P 25A 10kA</b>	1P	25A	10kA	12/240	<b>4.90</b>
9428 <b>BG10 1P 32A 10kA</b>	1P	32A	10kA	12/240	<b>5.00</b>
9429 <b>BG10 1P 40A 10kA</b>	1P	40A	10kA	12/240	<b>5.10</b>
9430 <b>BG10 1P 50A 10kA</b>	1P	50A	10kA	12/240	<b>5.50</b>
9431 <b>BG10 1P 63A 10kA</b>	1P	63A	10kA	12/240	<b>5.50</b>



## Otomatik Sigortalar - Kaçak Akım Koruma Anahtarları

## 10kA Otomatik Sigortalar C Tipi - Trifaze



Model	Kutup Sayısı	Anma Akımı	Kesme Kapasitesi	Kutu/Koli	Fiyat (USD)
9501 <b>BG10 3P 6A 10kA</b>	3P	6A	10kA	4/80	<b>17.00</b>
9502 <b>BG10 3P 10A 10kA</b>	3P	10A	10kA	4/80	<b>17.00</b>
9503 <b>BG10 3P 16A 10kA</b>	3P	16A	10kA	4/80	<b>17.00</b>
9504 <b>BG10 3P 20A 10kA</b>	3P	20A	10kA	4/80	<b>17.00</b>
9505 <b>BG10 3P 25A 10kA</b>	3P	25A	10kA	4/80	<b>17.00</b>
9506 <b>BG10 3P 32A 10kA</b>	3P	32A	10kA	4/80	<b>17.50</b>
9507 <b>BG10 3P 40A 10kA</b>	3P	40A	10kA	4/80	<b>18.00</b>
9508 <b>BG10 3P 50A 10kA</b>	3P	50A	10kA	4/80	<b>19.00</b>
9509 <b>BG10 3P 63A 10kA</b>	3P	63A	10kA	4/80	<b>19.00</b>

## Kaçak Akım Koruma Anahtarları - Monofaze 30mA



Model	Kutup Sayısı	Anma Akımı	Duyarlılık Derecesi	Kutu/Koli	Fiyat (USD)
9510 <b>BGK2 2P 25A 30mA</b>	2P (1P+N)	25A	30mA	1/100	<b>15.60</b>
9511 <b>BGK2 2P 32A 30mA</b>	2P (1P+N)	32A	30mA	1/100	<b>15.60</b>
9512 <b>BGK2 2P 40A 30mA</b>	2P (1P+N)	40A	30mA	1/100	<b>15.60</b>
9513 <b>BGK2 2P 63A 30mA</b>	2P (1P+N)	63A	30mA	1/100	<b>16.90</b>

## Kaçak Akım Koruma Anahtarları - Trifaze 30mA



Model	Kutup Sayısı	Anma Akımı	Duyarlılık Derecesi	Kutu/Koli	Fiyat (USD)
9514 <b>BGK4 4P 25A 30mA</b>	4P (3P+N)	25A	30mA	1/50	<b>22.30</b>
9515 <b>BGK4 4P 32A 30mA</b>	4P (3P+N)	32A	30mA	1/50	<b>22.30</b>
9516 <b>BGK4 4P 40A 30mA</b>	4P (3P+N)	40A	30mA	1/50	<b>22.30</b>
9517 <b>BGK4 4P 63A 30mA</b>	4P (3P+N)	63A	30mA	1/50	<b>24.00</b>

## Kaçak Akım Koruma Anahtarları - Monofaze 300mA Yangın



Model	Kutup Sayısı	Anma Akımı	Duyarlılık Derecesi	Kutu/Koli	Fiyat (USD)
9518 <b>BGK2 2P 25A 300mA</b>	2P (1P+N)	25A	30mA	1/100	<b>15.60</b>
9519 <b>BGK2 2P 32A 300mA</b>	2P (1P+N)	32A	30mA	1/100	<b>15.60</b>
9520 <b>BGK2 2P 40A 300mA</b>	2P (1P+N)	40A	30mA	1/100	<b>15.60</b>
9521 <b>BGK2 2P 63A 300mA</b>	2P (1P+N)	63A	30mA	1/100	<b>16.90</b>

## Kaçak Akım Koruma Anahtarları - Trifaze 300mA Yangın



Model	Kutup Sayısı	Anma Akımı	Duyarlılık Derecesi	Kutu/Koli	Fiyat (USD)
9522 <b>BGK4 4P 25A 300mA</b>	4P (3P+N)	25A	300mA	1/50	<b>22.30</b>
9523 <b>BGK4 4P 32A 300mA</b>	4P (3P+N)	32A	300mA	1/50	<b>22.30</b>
9524 <b>BGK4 4P 40A 300mA</b>	4P (3P+N)	40A	300mA	1/50	<b>22.30</b>
9525 <b>BGK4 4P 63A 300mA</b>	4P (3P+N)	63A	300mA	1/50	<b>24.00</b>
9526 <b>BGK4 4P 80A 300mA</b>	4P (3P+N)	80A	300mA	1/50	<b>37.00</b>
9527 <b>BGK4 4P 100A 300mA</b>	4P (3P+N)	100A	300mA	1/50	<b>39.00</b>
9528 <b>BGK4 4P 125A 300mA</b>	4P (3P+N)	125A	300mA	1/50	<b>80.00</b>



## BGKT (CSX2) Tip Kontaktörler

## Mini 24V DC Kontaktör - BGKT (CJX2) Tip

Model	Anma Gücü	Anma Akımı	Bobin Gerilimi	Kontak NA/NK	Kutu/ Koli	Fiyat USD
9601 <b>BGKT 0910-M 24DC</b>	4 kW	9A	24V DC	1 0	1/100	<b>10.00</b>



## Mini Kontaktör - BGKT (CJX2) Tip

Model	Anma Gücü	Anma Akımı	Bobin Gerilimi	Kontak NA/NK	Kutu/ Koli	Fiyat USD
9602 <b>BGKT 610-M</b>	2.2 kW	6A	220V AC	1 0	1/100	<b>8.50</b>
9603 <b>BGKT 910-M</b>	4 kW	9A	220V AC	1 0	1/100	<b>9.60</b>
9604 <b>BGKT 610-M 24AC</b>	4 kW	9A	24V AC	1 0	1/100	<b>9.60</b>



## 3 Kutuplu Kontaktörler - BGKT (CJX2) Tip

Model	Anma Gücü	Anma Akımı	Bobin Gerilimi	Kontak NA/NK	Kutu/ Koli	Fiyat USD
9605 <b>BGKT 09 01</b>	4 kW	9A	220V AC	0 1	1/50	<b>9.00</b>
9606 <b>BGKT 09 10</b>	4 kW	9A	220V AC	1 0	1/50	<b>9.00</b>
9607 <b>BGKT 12 01</b>	5.5 kW	12A	220V AC	0 1	1/50	<b>9.30</b>
9608 <b>BGKT 12 10</b>	5.5 kW	12A	220V AC	1 0	1/50	<b>9.30</b>
9609 <b>BGKT 18 01</b>	7.5 kW	18A	220V AC	0 1	1/50	<b>11.50</b>
9610 <b>BGKT 18 10</b>	7.5 kW	18A	220V AC	1 0	1/50	<b>11.50</b>
9611 <b>BGKT 25 01</b>	11 kW	25A	220V AC	0 1	1/40	<b>14.70</b>
9612 <b>BGKT 25 10</b>	11 kW	25A	220V AC	1 0	1/40	<b>14.70</b>
9613 <b>BGKT 32 01</b>	15 kW	32A	220V AC	0 1	1/40	<b>19.80</b>
9614 <b>BGKT 32 10</b>	15 kW	32A	220V AC	1 0	1/40	<b>19.80</b>
9615 <b>BGKT 40 11</b>	18.5 kW	40A	220V AC	1 1	1/20	<b>34.00</b>
9616 <b>BGKT 50 11</b>	22 kW	50A	220V AC	1 1	1/20	<b>35.90</b>
9617 <b>BGKT 65 11</b>	30 kW	65A	220V AC	1 1	1/20	<b>42.30</b>
9618 <b>BGKT 80 11</b>	37 kW	80A	220V AC	1 1	1/20	<b>59.00</b>
9619 <b>BGKT 95 11</b>	45 kW	95A	220V AC	1 1	1/20	<b>66.50</b>
9620 <b>BGKT F115</b>	55 kW	115A	220V AC	1 1	1/4	<b>105.00</b>
9621 <b>BGKT F150</b>	75 kW	150A	220V AC	1 1	1/4	<b>145.00</b>
9622 <b>BGKT F170</b>	90 kW	170A	220V AC	1 1	1/4	<b>170.00</b>
9623 <b>BGKT F205</b>	110 kW	205A	220V AC	1 1	1/4	<b>250.00</b>
9624 <b>BGKT F245</b>	130 kW	245A	220V AC	1 1	1/4	<b>290.00</b>



\* NA; Normalde açık - NK; Normalde kapalı

## BGKT (CJX2) Tip İçin Kapasitör - Kondansatör Kontaktörü İçin

Model	Anma Gücü	Kutu Adeti	Fiyat USD
9625 <b>BGKT 09-12-18-25 coil</b>	BGKT 25A için	10	<b>12.50</b>
9626 <b>BGKT 32 coil</b>	BGKT 32A için	10	<b>13.00</b>
9627 <b>BGKT 40-50-65 coil</b>	BGKT 40-50-65A için	10	<b>17.50</b>
9628 <b>BGKT 80-95 coil</b>	BGKT 95A için	6	<b>19.50</b>



## Termik Röleler



F4/11



F4/22

## BGKT (CJX2) Tip Kontaktörler İçin İlave Kontak Blokları

Model	Kontak NA/NK	Kutu/Koli	Fiyat USD
9701 <b>F4/20</b>	2 0	1/100	<b>3.00</b>
9702 <b>F4/02</b>	0 2	1/100	<b>3.00</b>
9703 <b>F4/11</b>	1 1	1/100	<b>3.00</b>
9704 <b>F4/22</b>	2 2	1/100	<b>5.00</b>
9705 <b>F4/40</b>	4 0	1/100	<b>5.00</b>
9706 <b>F4/31</b>	3 1	1/100	<b>5.00</b>
9707 <b>F4/13</b>	1 3	1/100	<b>5.00</b>
9708 <b>F4/04</b>	0 4	1/100	<b>5.00</b>

## JRS1 Termik Röleler - BGKT (CJX2) Tip Kontaktörler İçin

Model	Tip	Termik Ayar Sahası	Kullanılacak Kont. Tipi	Kutu/Koli	Fiyat (USD)
9709 <b>JRS1-D1305 0.63-1A</b>	JRS1-D 13	0.63-1A	BGKT 09..32	1/100	<b>9.90</b>
9710 <b>JRS1-D1306 1-1.6A</b>	JRS1-D 13	1-1.6A	BGKT 09..32	1/100	<b>9.90</b>
9711 <b>JRS1-D1307 1.6-2.5A</b>	JRS1-D 13	1.6-2.5A	BGKT 09..32	1/100	<b>9.90</b>
9712 <b>JRS1-D1308 2.5-4A</b>	JRS1-D 13	2.5-4A	BGKT 09..32	1/100	<b>9.90</b>
9713 <b>JRS1-D1310 4-6.3A</b>	JRS1-D 13	4-6.3A	BGKT 09..32	1/100	<b>9.90</b>
9714 <b>JRS1-D1312 5.5-8A</b>	JRS1-D 13	5.5-8A	BGKT 09..32	1/100	<b>9.90</b>
9715 <b>JRS1-D1314 7-10A</b>	JRS1-D 13	7-10A	BGKT 09..32	1/100	<b>9.90</b>
9716 <b>JRS1-D1316 9-13A</b>	JRS1-D 13	9-13A	BGKT 09..32	1/100	<b>9.90</b>
9717 <b>JRS1-D1321 12-18A</b>	JRS1-D 13	12-18A	BGKT 09..32	1/100	<b>9.90</b>
9718 <b>JRS1-D1322 17-25A</b>	JRS1-D 13	17-25A	BGKT 09..32	1/100	<b>9.90</b>
9719 <b>JRS1-D2353 23-32A</b>	JRS1-D 23	23-32A	BGKT 25..32	1/50	<b>12.40</b>
9720 <b>JRS1-D3355 30-40A</b>	JRS1-D 33	30-40A	BGKT 40..95	1/50	<b>24.00</b>
9721 <b>JRS1-D3357 37-50A</b>	JRS1-D 33	37-50A	BGKT 50..95	1/50	<b>24.00</b>
9722 <b>JRS1-D3359 48-57A</b>	JRS1-D 33	48-57A	BGKT 50..95	1/50	<b>24.00</b>



## JRS2 Termik Röleler - BGKS (CJX1) Tip Kontaktörler İçin

Model	Tip	Termik Ayar Sahası	Motor Gücü (Kw)	Kutu/Koli	Fiyat (USD)
9723 <b>JRS2-63 0.63-1A</b>	JRS2 - 63	0.63-1A	0.25 kW	1/50	<b>17.50</b>
9724 <b>JRS2-63 1-1.6A</b>	JRS2 - 63	1-1.6A	0.37 kW	1/50	<b>17.50</b>
9725 <b>JRS2-63 1.6-2.5A</b>	JRS2 - 63	1.6-2.5A	1 kW	1/50	<b>17.50</b>
9726 <b>JRS2-63 2.5-4A</b>	JRS2 - 63	2.5-4A	1.5 kW	1/50	<b>17.50</b>
9727 <b>JRS2-63 4-6.3A</b>	JRS2 - 63	4-6.3A	2.2 kW	1/50	<b>17.50</b>
9728 <b>JRS2-63 6.3-10A</b>	JRS2 - 63	6.3-10A	4 kW	1/50	<b>17.50</b>
9729 <b>JRS2-63 10-16A</b>	JRS2 - 63	10-16A	7.5 kW	1/50	<b>17.50</b>
9730 <b>JRS2-63 16-25A</b>	JRS2 - 63	16-25A	11 kW	1/50	<b>17.50</b>
9731 <b>JRS2-63 25-40A</b>	JRS2 - 63	25-40A	15 kW	1/50	<b>18.50</b>
9732 <b>JRS2-63 40-57A</b>	JRS2 - 63	40-57A	22 kW	1/25	<b>18.50</b>
9733 <b>JRS2-63 50-63A</b>	JRS2 - 63	50-53A	30 kW	1/25	<b>18.50</b>



## 3 Kutuplu Kontaktörler - BGKT (CJX2) Tip

Model	Anma Gücü	Anma Akımı	Bobin Gerilimi	Kontak NA/NK	Kutu/Koli	Fiyat USD	
9801	<b>BGKS 4001 9A</b>	4 kW	9A	220V AC	0 1	1/50	<b>12.50</b>
9802	<b>BGKS 4010 9A</b>	4 kW	9A	220V AC	1 0	1/50	<b>12.50</b>
9803	<b>BGKS 4011 9A</b>	4 kW	9A	220V AC	1 1	1/50	<b>12.50</b>
9804	<b>BGKS 4022 9A</b>	4 kW	9A	220V AC	2 2	1/50	<b>12.50</b>
9805	<b>BGKS 4101 12A</b>	5.5 kW	12A	220V AC	0 1	1/50	<b>13.30</b>
9806	<b>BGKS 4110 12A</b>	5.5 kW	12A	220V AC	1 0	1/50	<b>13.30</b>
9807	<b>BGKS 4111 12A</b>	5.5 kW	12A	220V AC	1 1	1/50	<b>13.30</b>
9808	<b>BGKS 4122 12A</b>	5.5 kW	12A	220V AC	2 2	1/50	<b>13.30</b>
9809	<b>BGKS 4201 16A</b>	7.5 kW	16A	220V AC	0 1	1/50	<b>16.80</b>
9810	<b>BGKS 4210 16A</b>	7.5 kW	16A	220V AC	1 0	1/50	<b>16.80</b>
9811	<b>BGKS 4211 16A</b>	7.5 kW	16A	220V AC	1 1	1/50	<b>16.80</b>
9812	<b>BGKS 4222 16A</b>	7.5 kW	16A	220V AC	2 2	1/50	<b>16.80</b>
9813	<b>BGKS 4301 22A</b>	11 kW	22A	220V AC	0 1	1/50	<b>18.00</b>
9814	<b>BGKS 4310 22A</b>	11 kW	22A	220V AC	1 0	1/50	<b>18.00</b>
9815	<b>BGKS 4311 22A</b>	11 kW	22A	220V AC	1 1	1/50	<b>18.00</b>
9816	<b>BGKS 4322 22A</b>	11 kW	22A	220V AC	2 2	1/50	<b>18.00</b>
9817	<b>BGKS 4422 32A</b>	15 kW	32A	220V AC	2 2	1/20	<b>33.00</b>
9818	<b>BGKS 4622 45A</b>	22 kW	45A	220V AC	2 2	1/12	<b>49.00</b>
9819	<b>BGKS 4722 63A</b>	30 kW	63A	220V AC	2 2	1/12	<b>55.00</b>
9820	<b>BGKS 4822 75A</b>	37 kW	75A	220V AC	2 2	1/8	<b>80.00</b>
9821	<b>BGKS 4922 85A</b>	45 kW	85A	220V AC	2 2	1/8	<b>90.00</b>
9822	<b>BGKS 5022 110A</b>	55 kW	110A	220V AC	2 2	1/6	<b>125.00</b>
9823	<b>BGKS 5122 140A</b>	75 kW	140A	220V AC	2 2	1/6	<b>130.00</b>
9824	<b>BGKS 5222 170A</b>	90 kW	170A	220V AC	2 2	1/4	<b>245.00</b>
9825	<b>BGKS 5322 205A</b>	110 kW	205A	220V AC	2 2	1/4	<b>260.00</b>
9826	<b>BGKS 5522 300A</b>	160 kW	300A	220V AC	2 2	1/2	<b>380.00</b>

NA: Normalde Açık • NK: Normalde Kapalı

## Endüstriyel Röleler - 8 Pin / 10 Amper

Model	Pin/Amper	Kontak Sayısı	Voltajı	Kutu Adeti	Fiyat (USD)	
9827	<b>M8P 24AC</b>	8 PIN/10 AMPER	2	24V AC	20	<b>5.30</b>
9828	<b>M8P 24DC</b>	8 PIN/10 AMPER	2	24V DC	20	<b>5.30</b>
9829	<b>M8P 220AC</b>	8 PIN/10 AMPER	2	220V AC	20	<b>5.30</b>

## Endüstriyel Röleler - 8 Pin / 10 Amper

Model	Pin/Amper	Kontak Sayısı	Voltajı	Kutu Adeti	Fiyat (USD)	
9830	<b>8P 12AC</b>	8 PIN/10 AMPER	2	12V AC	10	<b>6.00</b>
9831	<b>8P 12DC</b>	8 PIN/10 AMPER	2	12V DC	10	<b>6.00</b>
9832	<b>8P 24AC</b>	8 PIN/10 AMPER	2	24V AC	10	<b>6.00</b>
9833	<b>8P 24DC</b>	8 PIN/10 AMPER	2	24V DC	10	<b>6.00</b>
9834	<b>8P 110AC</b>	8 PIN/10 AMPER	2	110V AC	10	<b>6.00</b>
9835	<b>8P 220AC</b>	8 PIN/10 AMPER	2	220V AC	10	<b>6.00</b>



## Röleler - Kompakt Şalterler



## Endüstriyel Röleler - 14 Pin / 10 Amper

	Model	Pin/Amper	Kontak Sayısı	Voltajı	Kutu Adeti	Fiyat (USD)
9901	<b>M14P 24AC</b>	14 PIN/10 AMPER	4	24V AC	20	<b>5.40</b>
9902	<b>M14P 24DC</b>	14 PIN/10 AMPER	4	24V DC	20	<b>5.40</b>
9903	<b>M14P 220AC</b>	14 PIN/10 AMPER	4	220V AC	20	<b>5.40</b>



## Endüstriyel Röleler - 11 Pin / 10 Amper

	Model	Pin/Amper	Kontak Sayısı	Voltajı	Kutu Adeti	Fiyat (USD)
9904	<b>11P 12AC</b>	11 PIN/10 AMPER	3	12V AC	10	<b>7.30</b>
9905	<b>11P 12DC</b>	11 PIN/10 AMPER	3	12V DC	10	<b>7.30</b>
9906	<b>11P 24AC</b>	11 PIN/10 AMPER	3	24V AC	10	<b>7.30</b>
9907	<b>11P 24DC</b>	11 PIN/10 AMPER	3	24V DC	10	<b>7.30</b>
9908	<b>11P 110AC</b>	11 PIN/10 AMPER	3	110V AC	10	<b>7.30</b>
9909	<b>11P 220AC</b>	11 PIN/10 AMPER	3	220V AC	10	<b>7.30</b>

 11PS 90  
8PS 90

 8PS 78  
14PS 78

## Röle Soketleri

	Model	Pin Sayısı	Kutu/Koli	Fiyat USD
9910	<b>8PS 78</b>	8 PIN	10	<b>3.20</b>
9911	<b>14PS 78</b>	14 PIN	10	<b>3.20</b>
9912	<b>11PS 90</b>	11 PIN	10	<b>3.00</b>
9913	<b>8PS 90</b>	8 PIN	10	<b>3.00</b>



## BGKK Küçük Tip Akım ve Yangın Koruma Röleli Kompakt Şalterler - Kombine

	Model	Tip	Nominal Akım	Akım Kesme Kapasitesi Icu (kA)	Kutu/ Koli	Fiyat USD
9914	<b>BGKK 100A</b>	BGKK 225	100A	25 kA	1/8	<b>210.00</b>
9915	<b>BGKK 125A</b>	BGKK 225	125A	25 kA	1/8	<b>230.00</b>
9916	<b>BGKK 160A</b>	BGKK 225	160A	25 kA	1/8	<b>245.00</b>
9917	<b>BGKK 200A</b>	BGKK 225	200A	25 kA	1/8	<b>255.00</b>
9918	<b>BGKK 225A</b>	BGKK 225	225A	25 kA	1/8	<b>290.00</b>
9919	<b>BGKK 250A</b>	BGKK 400	250A	35 kA	1/2	<b>500.00</b>
9920	<b>BGKK 315A</b>	BGKK 400	315A	35 kA	1/2	<b>520.00</b>
9921	<b>BGKK 400A</b>	BGKK 400	400A	35 kA	1/2	<b>570.00</b>

## BGAK Tip Ayar Sahalı Kompakt Şalterler



	Model	Tip	Nominal Akım	Akım Kesme Kapasitesi Icu (kA)	Kutu/ Koli	Fiyat USD
9922	<b>BGAK 63/80A</b>	BGAK	63-80A	15 kA	1/20	<b>60.00</b>
9923	<b>BGAK 80/100A</b>	BGAK	80-100A	15 kA	1/20	<b>60.00</b>
9924	<b>BGAK 100/125A</b>	BGAK	100-125A	15 kA	1/12	<b>105.00</b>
9925	<b>BGAK 125/160A</b>	BGAK	125-160A	15 kA	1/12	<b>110.00</b>
9926	<b>BGAK 160/200A</b>	BGAK	160-200A	15 kA	1/12	<b>115.00</b>
9927	<b>BGAK 200/250A</b>	BGAK	200-250A	15 kA	1/12	<b>120.00</b>

\* Ics=%50 Icu

## BGSK Tip Sabit Kompakt Şalterler - Açırma Bobin Takılabilir

Model	Tip	Termik Ayar Sahası	Akım Kesme Kapasitesi Icu (kA)	Kutu/ Koli	Fiyat USD	
10001	<b>BGSK 32A</b>	BGSK	32A	20 kA	1/20	<b>47.00</b>
10002	<b>BGSK 40A</b>	BGSK	40A	20 kA	1/20	<b>47.00</b>
10003	<b>BGSK 50A</b>	BGSK	50A	20 kA	1/20	<b>47.00</b>
10004	<b>BGSK 63A</b>	BGSK	63A	20 kA	1/20	<b>47.00</b>
10005	<b>BGSK 80A</b>	BGSK	80A	20 kA	1/20	<b>47.00</b>
10006	<b>BGSK 100A</b>	BGSK	100A	20 kA	1/20	<b>47.00</b>
10007	<b>BGSK 125A</b>	BGSK	125A	25 kA	1/20	<b>90.00</b>
10008	<b>BGSK 160A</b>	BGSK	160A	25 kA	1/12	<b>92.00</b>
10009	<b>BGSK 225A</b>	BGSK	225A	25 kA	1/12	<b>92.00</b>
10010	<b>BGSK 250A</b>	BGSK	250A	25 kA	1/4	<b>240.00</b>
10011	<b>BGSK 315A</b>	BGSK	315A	25 kA	1/4	<b>240.00</b>
10012	<b>BGSK 400A</b>	BGSK	400A	25 kA	1/4	<b>260.00</b>
10013	<b>BGSK 600A</b>	BGSK	600A	-	1/2	<b>480.00</b>
10014	<b>BGSK 800A</b>	BGSK	800A	-	1/2	<b>610.00</b>

\* Ics=%50 Icu

## BGSK Tip Sabit Kompakt Şalter için Açırma Bobini

Model	Tip	Kutu	Fiyat
10015	<b>BGSK Bobin 32-100A</b>	BGSK	-
10016	<b>BGSK Bobin 125-400A</b>	BGSK	-

## CDM2 Tip Sabit Kompakt Şalterler

Model	Tip	Termik Ayar Sahası	Kesme Kapasitesi Icu (kA)	Kutu/Koli	Fiyat (USD)	
10017	<b>CDM2 30A</b>	CDM2 100	30A	14 kA	1/16	<b>50.50</b>
10018	<b>CDM2 40A</b>	CDM2 100	40A	14 kA	1/16	<b>50.50</b>
10019	<b>CDM2 50A</b>	CDM2 100	50A	14 kA	1/16	<b>50.50</b>
10020	<b>CDM2 60A</b>	CDM2 100	60A	14 kA	1/16	<b>50.50</b>
10021	<b>CDM2 75A</b>	CDM2 100	75A	14 kA	1/16	<b>50.50</b>
10022	<b>CDM2 100A</b>	CDM2 100	100A	14 kA	1/16	<b>50.50</b>
10023	<b>CDM2 125A</b>	CDM2 225	125A	20 kA	1/8	<b>111.00</b>
10024	<b>CDM2 150A</b>	CDM2 225	150A	20 kA	1/8	<b>111.00</b>
10025	<b>CDM2 225A</b>	CDM2 225	225A	20 kA	1/8	<b>118.00</b>
10026	<b>CDM2 250A</b>	CDM2 400	250A	25 kA	1/3	<b>150.00</b>
10027	<b>CDM2 300A</b>	CDM2 400	300A	25 kA	1/3	<b>155.00</b>
10028	<b>CDM2 400A</b>	CDM2 400	400A	25 kA	1/3	<b>170.00</b>
10029	<b>CDM2 600A</b>	CDM2 600	600A	35 kA	1/1	<b>380.00</b>
10030	<b>CDM2 800A</b>	CDM2 1250	800A	45 kA	1/1	<b>580.00</b>
10031	<b>CDM2 1000A</b>	CDM2 1250	1000A	45 kA	1/1	<b>990.00</b>
10032	<b>CDM2 1250A</b>	CDM2 1250	1250A	45 kA	1/1	<b>1,050.00</b>

\* Ics=%50 Icu



## Kompakt Şalterler - Motor Koruma Şalterleri

## HL 20 Tip Kaçak Akım Röleli (Kombine) Kompakt Şalterler



	Model	Tip	Nominal Akım	Kesme Kapasitesi Icu (kA)	Kutu/Koli	Fiyat (USD)
10101	<b>HL20-160 100A</b>	HL20-160	100A	12 kA	1/4	<b>120.00</b>
10102	<b>HL20-160 125A</b>	HL20-160	125A	12 kA	1/4	<b>135.00</b>
10103	<b>HL20-160 160A</b>	HL20-160	160A	12 kA	1/4	<b>145.00</b>
10104	<b>HL20-250 200A</b>	HL20-250	200A	15 kA	1/4	<b>170.00</b>
10105	<b>HL20-250 250A</b>	HL20-250	250A	15 kA	1/4	<b>180.00</b>
10106	<b>HL20-400 300A</b>	HL20-400	300A	20 kA	1/1	<b>280.00</b>
10107	<b>HL20-400 400A</b>	HL20-400	400A	20 kA	1/1	<b>290.00</b>

\* Ics=%50 Icu

## BG (HL-518) Motor Koruma Şalterleri



	Model	Tip	Termik Ayar Sahası	Kutu/Koli	Fiyat (USD)
10108	<b>BG518 0.63-1A</b>	BG - 518	0.63-1A	1/20	<b>26.00</b>
10109	<b>BG518 1-1.6A</b>	BG - 518	1-1.6A	1/20	<b>26.00</b>
10110	<b>BG518 1.6-2.5A</b>	BG - 518	1.6-2.5A	1/20	<b>26.00</b>
10111	<b>BG518 2.5-4A</b>	BG - 518	2.5-4A	1/20	<b>26.00</b>
10112	<b>BG518 4-6.3A</b>	BG - 518	4-6.3A	1/20	<b>26.00</b>
10113	<b>BG518 6-10A</b>	BG - 518	6-10A	1/20	<b>26.00</b>
10114	<b>BG518 9-14A</b>	BG - 518	9-14A	1/20	<b>26.00</b>
10115	<b>BG518 13-18A</b>	BG - 518	13-18A	1/20	<b>26.00</b>
10116	<b>BG518 17-23A</b>	BG - 518	17-23A	1/20	<b>26.00</b>
10117	<b>BG518 20-25A</b>	BG - 518	20-25A	1/20	<b>26.00</b>
10118	<b>BG518 24-32A</b>	BG - 518	24-32A	1/20	<b>26.00</b>

## BG (HL-518) Motor Koruma Şalterleri Kutusu



	Model	Tip	Kutu/Koli	Fiyat (USD)
10119	<b>BG518 BOX</b>	BG - 518	1/50	<b>9.60</b>

## BG (HL-518) Motor Koruma Şalterleri Yedek Blokları



	Model	Tip	Kontak NA/NK	Kutu/Koli	Fiyat (USD)
10120	<b>BG518 YBY</b>	BG - 518	1 1	1/100	<b>5.10</b>
10121	<b>BG518 YBÜ</b>	BG - 518	1 1	1/100	<b>5.10</b>

\* NA; Normalde açık - NK; Normalde kapalı

## Switchler

## Limit Switch - Metal Seri

Model	Açıklama	Kutu/Koli	Fiyat (USD)
10201	<b>LS11</b> Doğrusal Pim	10/90	<b>12.50</b>
10202	<b>LS12</b> Kol Makara	10/90	<b>12.50</b>
10203	<b>LS13</b> Düz Makara	10/90	<b>12.50</b>
10204	<b>LS14</b> Döner Kol Metal Makara	10/80	<b>12.50</b>
10205	<b>LS15</b> Açısal Metal Mak. Ayarlı Uzun Kol	10/80	<b>12.50</b>
10206	<b>LS16</b> Açısal Çok Yönlü Tel	10/80	<b>12.50</b>
10207	<b>LS18</b> Açısal Çok Yönlü Spiral	10/80	<b>12.50</b>



## Limit Switch - Plastik Seri

Model	Açıklama	Kutu/Koli	Fiyat (USD)
10208	<b>LS21</b> Doğrusal Pim	10/100	<b>7.70</b>
10209	<b>LS22</b> Döner Kol Metal Makara	10/100	<b>7.70</b>
10210	<b>LS23</b> Doğrusal Makara	10/100	<b>7.70</b>
10211	<b>LS23 R</b> Doğrusal Makara (Resetli)	10/100	<b>8.90</b>
10212	<b>LS24</b> Doğrusal Kol Makara	10/100	<b>7.70</b>
10213	<b>LS25</b> Açısal Metal Mak. Ayarlı Uzun Kol	10/100	<b>7.70</b>
10214	<b>LS26</b> Açısal Çok Yönlü Tel	10/100	<b>7.70</b>
10215	<b>LS27</b> Doğrusal Kol Makara	10/100	<b>7.70</b>
10216	<b>LS28</b> Açısal Çok Yönlü Spiral	10/100	<b>7.70</b>
10217	<b>LS29</b> Açısal Ayarlı Uzun Döner Kol Makara	10/50	<b>8.40</b>



Switchler

**Limit Switch - Metal Gövde Plastik Kapak**

Model	Açıklama	Kutu/Koli	Fiyat (USD)
10301	<b>LS81 M.Gövde</b> Dogrusal Pim	10/100	<b>8.50</b>
10302	<b>LS82 M.Gövde</b> Dogrusal Makara	10/100	<b>8.50</b>
10303	<b>LS83 M.Gövde</b> Dogrusal TERS Makara	10/100	<b>8.50</b>
10304	<b>LS84 M.Gövde</b> Döner Kol Metal Makara	10/100	<b>10.30</b>
10305	<b>LS86 M.Gövde</b> Açısal Çok Yönlü Spiral	10/100	<b>8.50</b>
10306	<b>LS87 M.Gövde</b> Açısal Ayarlı Çubuk Kol	10/100	<b>8.50</b>
10307	<b>LS88 M.Gövde</b> Açısal Ayarlı Kol Metal Makara	10/100	<b>10.50</b>
10308	<b>LS89 M.Gövde</b> Açısal Çok Yönlü Tel	10/100	<b>9.50</b>



**Mikro Switch**

Model	Açıklama	Kutu/Koli	Fiyat (USD)
10309	<b>LS71 Mikro Swtc</b> Düz Palet	20/480	<b>4.50</b>
10310	<b>LS72 Mikro Swtc</b> Kısa Palet	20/480	<b>4.50</b>
10311	<b>LS73 Mikro Swtc</b> Makaralı Palet	20/480	<b>4.50</b>
10312	<b>LS74 Mikro Swtc</b> Makaralı Kısa Palet	20/480	<b>4.50</b>
10313	<b>LS76 Mikro Swtc</b> Kısa Pim	20/480	<b>4.50</b>
10314	<b>LS77 Mikro Swtc</b> Düz Pim	20/480	<b>4.50</b>
10315	<b>LS78 Mikro Swtc</b> Düz Makara	20/480	<b>4.90</b>
10316	<b>LS79 Mikro Swtc</b> Ters Makara	20/480	<b>4.90</b>





## İzoleli Yüksük ve Pabuçlar

### İzoleli Tek Girişli Yüksük

Model	Kablo Kesiti (mm)	Yüksük Boyu (mm)	Renk	Kutu Adeti	Fiyat USD
10401 <b>ITY 01 0508</b>	0.50 mm	8.00	Turuncu	500	<b>8.40</b>
10402 <b>ITY 02 7508</b>	0.75 mm	8.00	Beyaz	500	<b>8.40</b>
10403 <b>ITY 03 1008</b>	1 mm	8.00	Sarı	500	<b>8.40</b>
10404 <b>ITY 04 1508</b>	1.5 mm	8.00	Kırmızı	500	<b>8.40</b>
10405 <b>ITY 05 2508</b>	2.5 mm	8.00	Mavi	500	<b>10.50</b>
10406 <b>ITY 06 4009</b>	4 mm	9.00	Gri	250	<b>7.40</b>
10407 <b>ITY 07 6012</b>	6 mm	12.00	Siyah	250	<b>12.40</b>
10408 <b>ITY 08 10-12</b>	10 mm	12.00	Fildisi	100	<b>5.95</b>
10409 <b>ITY 09 16-12</b>	16 mm	12.00	Koyu Yeşil	100	<b>9.00</b>
10410 <b>ITY 10 25-16</b>	25 mm	16.00	Kahverengi	50	<b>9.60</b>
10411 <b>ITY 11 35-16</b>	35 mm	16.00	Krem	40	<b>9.60</b>
10412 <b>ITY 12 50-20</b>	50 mm	20.00	Açık Yeşil	20	<b>7.00</b>



### İzoleli Çift Girişli Yüksük

Model	Kablo Kesiti (mm)	Yüksük Boyu (mm)	Renk	Kutu Adeti	Fiyat USD
10413 <b>ICY 01 0508</b>	2x0.50	8.00	Beyaz	500	<b>16.20</b>
10414 <b>ICY 02 7508</b>	2x0.75	8.00	Mavi	500	<b>16.20</b>
10415 <b>ICY 03 1008</b>	2x1	8.00	Kırmızı	500	<b>16.20</b>
10416 <b>ICY 04 1508</b>	2x1.5	8.00	Siyah	500	<b>16.20</b>
10417 <b>ICY 05 2510</b>	2x2.5	10	Gri	250	<b>11.90</b>
10418 <b>ICY 06 4012</b>	2x4	12	Turuncu	100	<b>9.50</b>
10419 <b>ICY 07 6014</b>	2x6	14	Yeşil	100	<b>12.60</b>



### İzoleli Yuvarlak Tip Pabuç

Model	Kablo Kesiti (mm)	Civata	Delik Çapı (mm)	Renk	Kutu Adeti	Fiyat USD
10420 <b>IYP 1.5-4 YUV</b>	0.50-1.5 mm	M4	4.3	Kırmızı	200	<b>8.00</b>
10421 <b>IYP 1.5-5 YUV</b>	0.50-1.5 mm	M5	5.3	Kırmızı	200	<b>9.00</b>
10422 <b>IYP 1.5-6 YUV</b>	0.50-1.5 mm	M6	6.5	Kırmızı	200	<b>13.00</b>
10423 <b>IYP 1.5-8 YUV</b>	0.50-1.5 mm	M8	8.4	Kırmızı	200	<b>13.00</b>
10424 <b>IYP 2.5-4 YUV</b>	1.5-2.5 mm	M4	4.3	Mavi	200	<b>9.50</b>
10425 <b>IYP 2.5-5 YUV</b>	1.5-2.5 mm	M5	5.3	Mavi	200	<b>12.70</b>
10426 <b>IYP 2.5-6 YUV</b>	1.5-2.5 mm	M6	6.5	Mavi	200	<b>16.30</b>
10427 <b>IYP 2.5-8 YUV</b>	1.5-2.5 mm	M8	8.4	Mavi	200	<b>16.50</b>
10428 <b>IYP 6-4 YUV</b>	4-6 mm	M4	4.3	Sarı	100	<b>11.00</b>
10429 <b>IYP 6-5 YUV</b>	4-6 mm	M5	5.3	Sarı	100	<b>11.60</b>
10430 <b>IYP 6-6 YUV</b>	4-6 mm	M6	6.5	Sarı	100	<b>14.50</b>
10431 <b>IYP 6-8 YUV</b>	4-6 mm	M8	8.4	Sarı	100	<b>16.50</b>

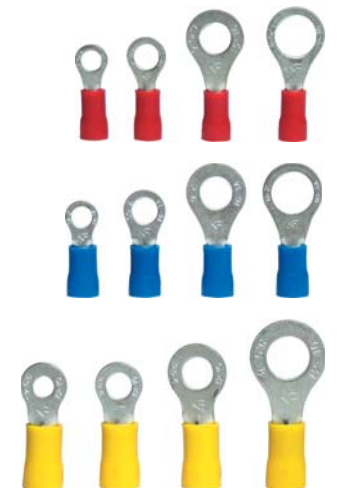

**İzoleli Pabuçlar**

**İzoleli Çatal Tip Pabuç**

Model	Kablo Kesiti (mm)	Civata	Delik Çapı (mm)	Renk	Kutu Adeti	Fiyat USD	
10501	<b>ICP 1.5-4 ÇTL</b>	0.50-1.5 mm	M4	4.3	Kırmızı	200	<b>8.80</b>
10502	<b>ICP 1.5-5 ÇTL</b>	0.50-1.5 mm	M5	5.3	Kırmızı	200	<b>9.90</b>
10503	<b>ICP 1.5-6 ÇTL</b>	0.50-1.5 mm	M6	6.5	Kırmızı	200	<b>12.40</b>
10504	<b>ICP 2.5-4 ÇTL</b>	1.5-2.5 mm	M4	4.3	Mavi	200	<b>10.30</b>
10505	<b>ICP 2.5-5 ÇTL</b>	1.5-2.5 mm	M5	5.3	Mavi	200	<b>10.90</b>
10506	<b>ICP 2.5-6 ÇTL</b>	1.5-2.5 mm	M6	6.5	Mavi	200	<b>12.60</b>
10507	<b>ICP 6-4 ÇTL</b>	4-6 mm	M4	4.3	Sarı	100	<b>9.90</b>
10508	<b>ICP 6-5 ÇTL</b>	4-6 mm	M5	5.3	Sarı	100	<b>11.50</b>
10509	<b>ICP 6-6 ÇTL</b>	4-6 mm	M6	6.5	Sarı	100	<b>11.50</b>

**İzoleli İğne Tip Terminal**

Model	Kablo Kesiti (mm)	Renk	Kutu Adeti	Fiyat USD	
10510	<b>IIT 1.5</b>	0.50-1.5 mm	Kırmızı	200	<b>10.60</b>
10511	<b>IIT 2.5</b>	1.5-2.5 mm	Mavi	200	<b>11.60</b>
10512	<b>IIT 4</b>	4-6 mm	Sarı	100	<b>11.60</b>

**İzoleli Ek Muf**

Model	Kablo Kesiti (mm)	Dış Çapı (mm)	Renk	Kutu Adeti	Fiyat USD	
10513	<b>IEM 1.5</b>	0.50-1.5 mm	1.7	Kırmızı	100	<b>6.30</b>
10514	<b>IEM 2.5</b>	1.5-2.5 mm	2.3	Mavi	100	<b>7.90</b>
10515	<b>IEM 4</b>	4-6 mm	3.4	Sarı	100	<b>12.40</b>

**İzoleli Faston Erkek Terminal**

Model	Kablo Kesiti/ Boy	Soket Gen. (mm)	Dış Çapı İç Çapı	Renk	Kutu Adeti	Fiyat USD	
10516	<b>IFE 1.5</b>	1.5 mm/21	6.35	4.3/1.7	Kırmızı	200	<b>14.20</b>
10517	<b>IFE 2.5</b>	2.5 mm/21	6.35	4.3/2.3	Mavi	200	<b>14.20</b>
10518	<b>IFE 4</b>	4 mm/25	6.35	5.7/5.7	Sarı	100	<b>10.80</b>

**İzoleli Faston Dişi Terminal**

Model	Kablo Kesiti (mm)	Renk	Kutu Adeti	Fiyat USD	
10519	<b>IDT 0.5-1</b>	0.50-1.5 mm	Kırmızı	200	<b>12.90</b>
10520	<b>IDT 1.5-2.5</b>	1.5-2.5 mm	Mavi	200	<b>14.20</b>
10521	<b>IDT 4.6</b>	4-6 mm	Sarı	100	<b>10.80</b>

**İzoleli Yüksük ve Pabuçlar - Sinyaller**
**Tam İzoleli Faston Dişi Terminal**

Model	Kablo Kesiti (mm)	Renk	Kutu Adeti	Fiyat USD
10601 <b>TDT 0.5-1</b>	0.50-1.5 mm	Kırmızı	100	<b>9.30</b>
10602 <b>TDT 1.5-2.5</b>	1.5-2.5 mm	Mavi	100	<b>9.30</b>
10603 <b>TDT 4.6</b>	4-6 mm	Sarı	100	<b>13.00</b>

**Yuvarlak Dişi Terminal**

Model	Kablo Kesiti (mm)	Renk	Kutu Adeti	Fiyat USD
10604 <b>YDT 0.5-1</b>	0.50-1.5 mm	Kırmızı	100	<b>9.20</b>
10605 <b>YDT 1.5-2.5</b>	1.5-2.5 mm	Mavi	100	<b>9.20</b>
10606 <b>YDT 4.6</b>	4-6 mm	Sarı	100	<b>13.00</b>

**Yuvarlak Erkek Terminal**

Model	Kablo Kesiti (mm)	Renk	Kutu Adeti	Fiyat USD
10607 <b>YET 0.5-1</b>	0.50-1.5 mm	Kırmızı	200	<b>13.00</b>
10608 <b>YET 1.5-2.5</b>	1.5-2.5 mm	Mavi	200	<b>13.00</b>
10609 <b>YET 4.6</b>	4-6 mm	Sarı	100	<b>10.80</b>

**Sinyaller - BA9s Neon Ampül Dahildir**

Model	Tip	Kutu/Koli	Fiyat USD
10610 <b>LAY5-EV161</b>	Beyaz	10/500	<b>0.80</b>
10611 <b>LAY5-EV163</b>	Yeşil	10/500	<b>0.70</b>
10612 <b>LAY5-EV164</b>	Kırmızı	10/500	<b>0.70</b>
10613 <b>LAY5-EV165</b>	Sarı	10/500	<b>0.70</b>
10614 <b>LAY5-EV166</b>	Mavi	10/500	<b>0.80</b>



LAY5-EV164

**Sinyaller - BA9s Neon Ampül Dahildir**

Model	Tip	Kutu/Koli	Fiyat USD
10615 <b>L.SB7-EV610</b>	Beyaz	10/500	<b>1.15</b>
10616 <b>L.SB7-EV630</b>	Yeşil	10/500	<b>1.05</b>
10617 <b>L.SB7-EV640</b>	Kırmızı	10/500	<b>1.05</b>
10618 <b>L.SB7-EV650</b>	Sarı	10/500	<b>1.05</b>
10619 <b>L.SB7-EV660</b>	Mavi	10/500	<b>1.15</b>



L.SB7-EV630

**Sinyaller - BA9s Neon Ampül Dahildir**

Model	Tip	Kutu/Koli	Fiyat USD
10620 <b>L.SB7-EV710</b>	Beyaz	10/500	<b>1.15</b>
10621 <b>L.SB7-EV730</b>	Yeşil	10/500	<b>1.05</b>
10622 <b>L.SB7-EV740</b>	Kırmızı	10/500	<b>1.05</b>
10623 <b>L.SB7-EV750</b>	Sarı	10/500	<b>1.05</b>
10624 <b>L.SB7-EV760</b>	Mavi	10/500	<b>1.15</b>



L.SB7-EV740

Butonlar

Start Butonu



LAY5-EA310

Model	Tip	Kutu/Koli	Fiyat USD
10701 LAY5-EA210	Siyah	20/320	2.00
10702 LAY5-EA310	Yeşil	20/320	2.00
10703 LAY5-EA510	Sarı	20/320	2.00
10704 LAY5-EA610	Mavi	20/320	2.00

Start Kontak Bloğu



LAY5-BE101

Model	Tip	Kutu/Koli	Fiyat USD
10705 LAY5-BE101	Yeşil	100/1600	0.80

Stop Kontak Bloğu



LAY5-BE102

Model	Tip	Kutu/Koli	Fiyat USD
10706 LAY5-BE102	Kırmızı	100/1600	0.80

I-0-II Rozet



L.ZB16-LAB2

Model	Tip	Kutu/Koli	Fiyat USD
10707 L.ZB 16-LAB2	L.ZB 16-LAB2	500/4000	0.16

Butonlar

Model	Açıklama	Renk	Kutu / Koli	Fiyat USD
10708 LAY5-EA420	Stop Butonu	Kırmızı	20/320	2.00
10709 LAY5-EL8325	İkiz Buton	Kırmızı-Yeşil	20/240	3.90
10710 LAY5-EA3311	İşaretili Start Butonu	Yeşil	20/240	2.00
10711 LAY5-EA3361	İşaretili Start Butonu	Yeşil	20/240	2.00
10712 LAY5-EA3341	İşaretili Start Butonu	Beyaz	20/240	2.00
10713 LAY5-EA3351	İşaretili Start Butonu	Siyah	20/240	2.00



LAY5-EA420



LAY5-EL8325



LAY5-EA3311



LAY5-EA3361



LAY5-EA3341



LAY5-EA3351

**Butonlar**
**İsaretili Start Stop Butonları**

Model	Açıklama	Renk	Kutu / Koli	Fiyat USD
10801 <b>LAY5-EA4322</b>	İşaretili Stop Butonu	Kırmızı O	20/240	<b>2.00</b>
10802 <b>LAY5-EA4342</b>	İşaretili Stop Butonu	Kırmızı Stop	20/240	<b>2.00</b>
10803 <b>LAY5-EA5331</b>	İşaretili Stop Butonu	Yeşil Start	20/240	<b>2.00</b>
10804 <b>LAY5-EA5321</b>	İşaretili Stop Butonu	Siyah Start	20/240	<b>2.00</b>
10805 <b>LAY5-EW8465-N</b>	İşiklı Yaylı İkiz Butonu BA9s Neon Ampül Dahildir	Kırmızı-Sarı-Yeşil	15/180	<b>5.40</b>
10806 <b>LAY5-EC420</b>	Mantar Kafa Kayıcı	Kırmızı	20/240	<b>2.20</b>
10807 <b>LAY5-ES542</b>	Mantar Kafa Çek-Çevir	Kırmızı	20/240	<b>2.90</b>



LAY5-EA4322



LAY5-EA5331



LAY5-EW8465-N



LAY5-EC420



LAY5-ES542

**Mandal Butonlar**

Model	Açıklama	Renk	Kutu / Koli	Fiyat USD
10808 <b>LAY5-ED210</b>	Kısa Mandal Buton Tek Taraf Kalıcı	Siyah	20/240	<b>2.10</b>
10809 <b>LAY5-ED330</b>	Kısa Mandal Buton Sağ-Sol Kayıcı	Siyah	20/240	<b>2.70</b>
10810 <b>LAY5-EJ210</b>	Uzun Mandal Buton Tek Taraf Kalıcı	Siyah	20/240	<b>2.10</b>
10811 <b>LAY5-EJ330</b>	Uzun Mandal Buton Sağ-Sol Kayıcı	Siyah	20/240	<b>2.70</b>
10812 <b>LAY5-ED410</b>	Kısa Mandal Buton Tek Taraf Kalıcı	Siyah	20/240	<b>2.10</b>
10813 <b>LAY5-ED530</b>	Kısa Mandal Buton Sağ-Sol Kayıcı	Siyah	20/240	<b>2.70</b>
10814 <b>LAY5-EJ410</b>	Uzun Mandal Buton Tek Taraf Kalıcı	Siyah	20/240	<b>2.10</b>
10815 <b>LAY5-EJ530</b>	Uzun Mandal Buton Sağ-Sol Kayıcı	Siyah	20/240	<b>2.70</b>
10816 <b>LAY5-EG210</b>	Anahtarlı Buton Tek Taraf Kalıcı	Siyah	20/240	<b>4.20</b>
10817 <b>LAY5-EG410</b>	Anahtarlı Buton Tek Taraf Kalıcı	Siyah	20/240	<b>4.20</b>
10818 <b>LAY5-EG330</b>	Anahtarlı Buton Sağ-Sol Kayıcı	Siyah	20/240	<b>4.60</b>
10819 <b>LAY5-EG530</b>	Anahtarlı Buton Sağ-Sol Kayıcı	Siyah	20/240	<b>4.60</b>



LAY5-ED210



LAY5-EJ210



LAY5-EG330

**Butonlar**

Model	Açıklama	Renk	Kutu / Koli	Fiyat USD
10820 <b>LAY5-EC310</b>	Mantar Kafa Kayıcı	Yeşil	15/180	<b>2.20</b>
10821 <b>LAY5-ES142</b>	Mantar Kafa Anahtarlı	Kırmızı	20/240	<b>5.50</b>
10822 <b>LAY5-EW3361</b>	İşiklı Start Butonu BA9s Neon Ampül Dahildir (IP40)	Yeşil	20/240	<b>4.60</b>
10823 <b>LAY5-EW3561</b>	İşiklı Start Butonu BA9s Neon Ampül Dahildir (IP40)	Sarı	20/240	<b>4.60</b>
10824 <b>LAY5-EW3661</b>	İşiklı Start Butonu BA9s Neon Ampül Dahildir (IP40)	Mavi	20/240	<b>4.60</b>
10825 <b>LAY5-EW3462</b>	İşiklı Stop Buton BA9s Ampül Dahil	Kırmızı	20/240	<b>4.60</b>



LAY5-EC310



LAY5-ES142



LAY5-EW3361



LAY5-EW3462

**Sinyal Lambaları**

L.AD22-22FM

**Buzzer**

	Model	Renk	Kutu/Koli	Fiyat USD
10901	<b>AD22-22FM</b>	Siyah (220V)	10/500	<b>4.20</b>
10902	<b>AD22-24FM</b>	Siyah (24V)	10/500	<b>4.20</b>



SDL.005G

**10 mm Kablolü Sinyal**

	Model	Renk	Kutu/Koli	Fiyat USD
10903	<b>SDL-005G</b>	Yeşil	200/2400	<b>0.41</b>
10904	<b>SDL-005R</b>	Kırmızı	200/2400	<b>0.41</b>
10905	<b>SDL-005Y</b>	Sarı	200/2400	<b>0.41</b>



L.AD22-22DS-R

**LED'li Sinyal Lambalar - 220V-50Hz**

	Model	Renk	Kutu/Koli	Fiyat USD
10906	<b>AD22-22DS-W</b>	Beyaz	10/500	<b>2.50</b>
10907	<b>AD22-22DS-G</b>	Yeşil	10/500	<b>2.20</b>
10908	<b>AD22-22DS-R</b>	Kırmızı	10/500	<b>2.20</b>
10909	<b>AD22-22DS-Y</b>	Sarı	10/500	<b>2.20</b>
10910	<b>AD22-22DS-B</b>	Mavi	10/500	<b>2.50</b>



L.AD22-24DS-G

**LED'li Sinyal Lambalar - 24V-AC/DC**

	Model	Renk	Kutu/Koli	Fiyat USD
10911	<b>AD22-24DS-W</b>	Beyaz	10/500	<b>2.50</b>
10912	<b>AD22-24DS-G</b>	Yeşil	10/500	<b>2.20</b>
10913	<b>AD22-24DS-R</b>	Kırmızı	10/500	<b>2.20</b>
10914	<b>AD22-24DS-Y</b>	Sarı	10/500	<b>2.20</b>
10915	<b>AD22-24DS-B</b>	Mavi	10/500	<b>2.50</b>



LAY5-EW3371



LAY5-EW3472

**LED'li Yaylı Start Butonu - 1 N/A - 220V - IP40**

	Model	Renk	Kutu/Koli	Fiyat USD
10916	<b>LAY5-EW3171</b>	Beyaz	20/240	<b>4.90</b>
10917	<b>LAY5-EW3371</b>	Yeşil	20/240	<b>4.90</b>
10918	<b>LAY5-EW3571</b>	Sarı	20/240	<b>4.90</b>
10919	<b>LAY5-EW3671</b>	Mavi	20/240	<b>4.90</b>
10920	<b>LAY5-EW3472</b>	Kırmızı	20/240	<b>4.90</b>



L.AD22-24SM

**LED'li Buzzer - IP40**

	Model	Renk	Kutu/Koli	Fiyat USD
10921	<b>AD22-22SM</b>	Kırmızı (220V)	8/400	<b>5.00</b>
10922	<b>AD22-24SM</b>	Kırmızı (24V)	8/400	<b>5.00</b>

**Vinç Kumanda Kutuları**
**LED'li Işıklı Yaylı İkiz Buton - IP40**

Model	Tip	Kutu/Koli	Fiyat USD
11001 <b>LAY5-EW8465-L</b>	Kırmızı, Yeşil, Sarı	15/180	<b>6.00</b>



LAY5-EW8465-L

**Boş Kumanda Buton Kutuları - IP54**

Model	Açıklama	Renk	Kutu / Koli	Fiyat USD
11002 <b>LAY5-BJ010</b>	1'li	Sarı-Siyah	1/100	<b>1.95</b>
11003 <b>LAY5-BE010</b>	1'li	Gri-Siyah	1/100	<b>1.95</b>
11004 <b>LAY5-BE020</b>	2'li	Gri-Siyah	1/100	<b>2.70</b>
11005 <b>LAY5-BE030</b>	3'lü	Gri-Siyah	1/100	<b>3.10</b>
11006 <b>LAY5-BE040</b>	4'lü	Gri-Siyah	1/100	<b>4.50</b>



BJ010

BE010

BE020

BE030

BE040

**Vinç Kumanda Buton Kutuları - IP65**

Model	Açıklama	Renk	Kutu / Koli	Fiyat USD
11007 <b>3SP-A371</b>	3'lü Tek Hızlı Acil Stoplu	Sarı-Siyah	1/20	<b>26.50</b>
11008 <b>3SP-A571</b>	5'li Tek Hızlı Acil Stoplu	Sarı-Siyah	1/20	<b>30.00</b>
11009 <b>3SP-A771</b>	7'li Tek Hızlı Acil Stoplu	Sarı-Siyah	1/20	<b>39.00</b>
11010 <b>3SP-A971</b>	9'lu Tek Hızlı Acil Stoplu	Sarı-Siyah	1/20	<b>45.00</b>



A371

A571

A771

A971

**Vinç Kumanda Buton Kutuları - IP65**

Model	Açıklama	Renk	Kutu / Koli	Fiyat USD
11011 <b>VK 2</b>	Vinç Kutusu 2'li	Turuncu	1/72	<b>4.60</b>
11012 <b>VK 4</b>	Vinç Kutusu 4'lü	Turuncu	1/72	<b>7.00</b>



VK2

VK4

**Pedallar**

Model	Açıklama	Renk	Kutu / Koli	Fiyat USD
11013 <b>PD.PP 1NA</b>	Plastik Gövdeli Pedal	1/100	1/72	<b>4.50</b>
11014 <b>PD.MP 1NA</b>	Metal Gövdeli Pedal	1/50	1/72	<b>5.50</b>

**Sıvı Seviye Şalterleri**

Model	Açıklama	Kutu / Koli	Fiyat USD
11015 <b>SSM 2M</b>	Su Seviye Kontrol Cihazı (2 Mt. Kablolü)	30	<b>10.00</b>



NOT